

7 YR WARRANTY
UK EXCLUSIVE UP TO 7 YEAR MOTOR WARRANTY

SeceuroGlide
Garage Doors

35 YEARS
1985-2020
ANNIVERSARY

SeceuroGlide Retail Price List The Original, Insulated Roller Garage Door

SWS UK

Jun 2021



SeceuroGlide Original: Rosewood Woodgrain Finish



SeceuroGlide Manual: Anthracite Colour Finish

An elegantly simple, yet well proven design.

SeceuroGlide is robust, reliable and durable – offering secure protection for your car and home.

A choice of low maintenance finishes, insulation and the convenience of remote automatic operation powered by a high quality SeceuroDrive Motor as standard make SeceuroGlide an excellent all round choice.

SeceuroGlide's aluminium slats lock into position to resist attack by intruders, while advanced insulation and brush sealing keeps out the cold and makes the door as weatherproof as it is secure. Vertical opening means you can make maximum use of your drive and garage space – parking safely just inches from the door.

SeceuroGlide garage doors are supplied complete with your choice of remote control, SeceuroSense Plus or Somfy Rollixo. You'll have a choice of handsets and the control equipment will include a courtesy light, bottom slat transmitter, safety edge and manual controls to operate the garage door..

A wide choice of finishes including Woodgrain and Painted Woodgrain help you to match your door to existing paintwork or woodgrain double glazing for a coherent look to your home's exterior. Our SeceuroGlide Original and SeceuroGlide Excel is also available powder coated to any RAL or BS number for a surcharge.

SeceuroGlide Excel combines all the benefits of SeceuroGlide Original with an even higher security specification, and is officially tested and approved to Police and insurance standards. Available at a surcharge on the price of a SeceuroGlide Original.

 **SeceuroGlide | Original**
Secure, Insulated Garage Doors

 **SeceuroGlide | Excel**
High Security, Insulated Garage Doors

 **SeceuroGlide | LT**
Standard, Insulated Garage Door

 **SeceuroGlide | Compact**
Low Headroom, Insulated Garage Door

 **SeceuroGlide | Manual**
Insulated Roller Garage Doors

 **SeceuroGlide | Vertico**
Secure, Vertical, Insulated Garage Doors

EXPLORE THE DIFFERENCES

SeceuroGlide | LT Standard, Insulated Garage Door



Aluminium End Plate

Standard, aluminium cast end plate.

Standard Locking System

A 70mm axle alongside plastic and steel locking straps secure your standard SeceuroGlide LT.

Endlocks

Crimped and stapled endlocks used to secure the curtain in operation.

SeceuroGlide | Original Secure, Insulated Garage Doors

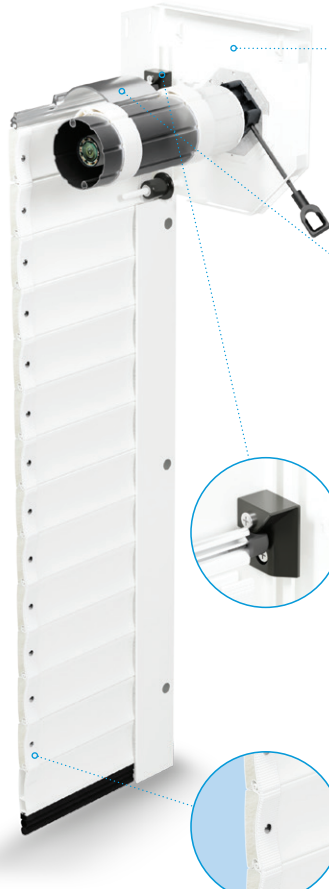

Steel End Plates

Steel end plates on the SeceuroGlide Original & Excel provide a sturdier design and increased security when compared with aluminium end plates.

Strength & Security

100 mm fluted axle, extruded aluminium hinges & top rail, provide greater strength when the door is in operation and in the locked position.

Unique Locking System

Both the Original and the Excel come with auto locking as standard for greater security, preventing the door from being lifted by an intruder. Centralised locking blocks ensure better running of the door during operation.

Security & Noise Reduction

Webbing on each side of the curtain provides additional security whilst also reducing the noise made by the curtain in operation.

SeceuroGlide | Excel High Security, Insulated Garage Doors



Reveal Fit

The SeceuroGlide Excel boasts Secured by Design and insurance approved Level One Security Rating for internal face and reveal fixtures.

Secured by Design

Upgraded 90 mm channels as standard, work alongside locking bottom slats to provide greater security, one of many features which make this door accredited by Secured by Design, even on between fit installations. Locking bottom slat on the SeceuroGlide Excel is designed to prevent the door being pushed out of the guides by an intruder.



SeceuroGlide | Original
Secure, Insulated Garage Doors

SeceuroGlide | Excel
High Security, Insulated Garage Doors



SeceuroGlide Original: Anthracite Colour Finish



SeceuroGlide Excel: White Colour Finish

Exceptional design and security.

Since the introduction of our hugely popular SeceuroGlide Original back in 1997, we have gone on to develop a series of garage doors which address everything from security and strength, to aesthetics, clever design and ease of use. In addition to the Secured by Design accreditation of the Original, the Excel also meets the higher specification set by the LPCB to create the most advanced roller door on the market.

Profiles & Sizes

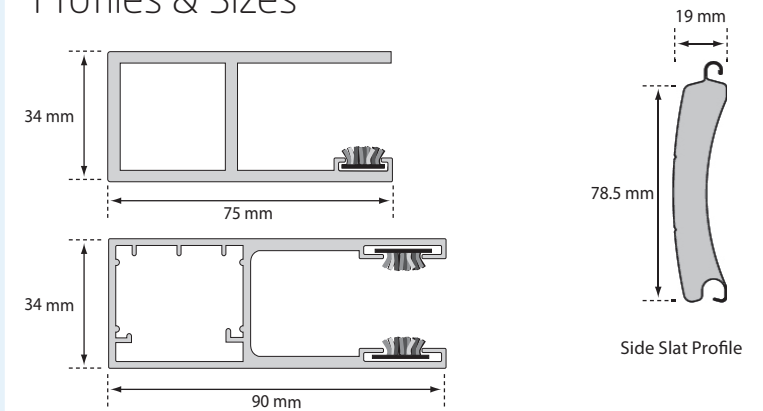

SeceuroGlide Excel guide rail notes:

- 90 mm guide rails supplied as standard on SeceuroGlide Excel.
- Reveal fitted guide rails require steel reinforcement plates.



Unique locking system

Both the Original and the Excel come with auto locking as standard for greater security.



Webbing

Webbing provides additional security, weatherproofing and noise reduction.



Strength and Security

100 mm fluted axle, extruded aluminium hinges and top rail make for a secure operation.

Standard Colours	Overall Guide Width (mm)											Excel max. width	
	NO BOX	1500	2000	2500	3000	3500	4000	4600	5200	5400	5590	Headroom	Total Height
	Guide Width*	75	75	75	75	75	75	75	90	90	90		
Guide Height (mm)	1900	1435	1591	1750	1917	2035	2326	2595	2885	2921	2958	300	2200
	2150	1497	1630	1762	1942	2071	2361	2626	2938	3019		300	2450
	2300	1537	1681	1796	1977	2108	2401	2683	2982	3265		300	2600
	2500	1610	1755	1863	2117	2166	2502	2860	3131	3376		300	2800
	3000	1726	1934	2125	2286	2331	2711	3093	3343			350	3350
	3500	1902	2061	2267	2502	2496	3048					350	3850
	3700	2078	2186	2409	2719	2662	3385					350	4050

*SeceuroGlide Excel will always be supplied with 90 mm guides

Excel max. height

Woodgrain Colours	Overall Guide Width (mm)											Excel max. width	
	NO BOX	1500	2000	2500	3000	3500	4000	4600	5200	5400	5590	Headroom	Total Height
	Guide Width*	75	75	75	75	75	75	75	90	90	90		
Guide Height (mm)	1900	1576	1778	1984	2198	2370	2706	3031	3376	3433	3489	300	2200
	2150	1655	1838	2043	2270	2451	2791	3135	3496	3597		300	2450
	2300	1706	1906	2085	2313	2509	2859	3209	3577	3885		300	2600
	2500	1720	1999	2170	2483	2601	2956	3433	3779	4046		300	2800
	3000	1948	2230	2495	2728	2855	3309	3779	4118			350	3350
	3500	2159	2403	2696	3017	3108	3663					350	3850
	3700	2370	2576	2897	3307	3362	4017					350	4050

*SeceuroGlide Excel will always be supplied with 90 mm guides

Excel max. height

STANDARD COLOURS **5** YR

Powder coated guide rails, bottom slats and vision slats (where specified) to match the curtain colour are supplied as standard.

End Plates: Galvanised finish as standard. Other colour options are available at a surcharge of **£24.96 per pair**.

Guides Rails: Other non standard colours available at **£37.30 per pair**.

For Painted Woodgrains we will use these RAL numbers: Walnut RAL 8014, Natural Oak RAL 1011.

FOILED WOODGRAIN COLOURS **10** YR

Powder coated guide rails, bottom slats and vision slats (where specified) are supplied brown as standard.

End Plates: Galvanised, white, brown or black as standard. Other colour options are available at a surcharge of **£24.96 per pair**.

Guides Rails: Other non standard colours available at **£37.30 per pair**.

Woodgrain finishes are supplied on one face only on brown slats as standard or white on request (other base colours available at a cost of £36.31 per square metre NET).

Premier finishes are also available at a surcharge additional to the price shown of £17.58 per square metre.

DON'T FORGET!
We can match your existing doors or windows!

For the ultimate choice, we can colour match to any RAL or BS colour.
From **£72.69 per square metre** (including colour matched guides, box and end plates where applicable)

Depending on RAL colour selected there may be a minimum powder coating surcharge to be applied.

EXCEL UPGRADE

Face fit guide rails **£115.84 (pair)**
Reveal fit guide rails **£160.34 (pair)**

Secured by Design
SBD
Police Preferred Specification

LPCB
UKAS
MANAGEMENT SYSTEMS
0007
Assessed to ISO 9001 & ISO 14001
Certified to LPCB ref. 306

SECEURODRIVE MOTOR

Supplied as standard: **FOC**

SOMFY MOTOR

Available with a surcharge: **£30 net**

CONTROL OPTIONS

Supplied as standard – choose ONE of the following:

SECEUROGLIDE | SECEUROSENSE PLUS
SOMFY | ROLLIXO

ALARM SURCHARGE

SECEUROSENSE PLUS
£86.75

SOMFY | ROLLIXO
Included

Standard Colours	Overall Guide Width (mm)											Excel max. width	
	HALF BOX	1500	2000	2500	3000	3500	4000	4600	5200	5400	5590	Headroom	Total Height
	Guide Width*	75	75	75	75	75	75	75	90	90	90		
Guide Height (mm)	1900	1485	1662	1870	2059	2201	2511	2810	3126	3172	3218	300	2200
	2150	1547	1696	1898	2094	2235	2546	2854	3178	3268		300	2450
	2300	1583	1751	1924	2117	2269	2585	2896	3223	3516		300	2600
	2500	1612	1822	1981	2258	2329	2626	3074	3372	3626		300	2800
	3000	1793	2055	2276	2465	2542	2960	3306	3588			350	3350
	3500	1994	2182	2417	2682	2754	3366					350	3850
	3700	2196	2309	2559	2901	2968	3773					350	4050

*SeceuroGlide Excel will always be supplied with 90 mm guides

Excel max. height

Woodgrain Colours	Overall Guide Width (mm)											Excel max. width	
	HALF BOX	1500	2000	2500	3000	3500	4000	4600	5200	5400	5590	Headroom	Total Height
	Guide Width*	75	75	75	75	75	75	75	90	90	90		
Guide Height (mm)	1900	1619	1840	2080	2337	2524	2883	3236	3607	3673	3740	300	2200
	2150	1701	1900	2149	2410	2605	2968	3337	3724	3837		300	2450
	2300	1747	1970	2171	2456	2663	3035	3412	3809	4122		300	2600
	2500	1789	2060	2248	2583	2756	3212	3636	4007	4285		300	2800
	3000	2038	2347	2645	2906	3053	3493	3918	4282			350	3350
	3500	2231	2526	2846	3197	3350	3958					350	3850
	3700	2423	2705	3049	3489	3647	4425					350	4050

*SeceuroGlide Excel will always be supplied with 90 mm guides

Excel max. height

STANDARD COLOURS **5** YR

Powder coated guide rails, bottom slats and vision slats (where specified) to match the curtain colour are supplied as standard.

Box & End Plates: White or brown as standard. Other colour options are available at a surcharge of **£28.47 per metre** (includes end plates).

Guides Rails: Other non standard colours available at **£37.30 per pair**.

For Painted Woodgrains we will use these RAL numbers: Walnut RAL 8014, Natural Oak RAL 1011.

FOILED WOODGRAIN COLOURS **10** YR

Powder coated guide rails, bottom slats and vision slats (where specified) are supplied brown as standard.

Box: White or brown as standard. Other colour options are available at a surcharge of **£28.47 per metre**.

End Plates: Galvanised, white, brown or black as standard. Other colour options are available at a surcharge of **£24.96 per pair**.

Guides Rails: Other non standard colours available at **£37.30 per pair**.

DON'T FORGET!
We can match your existing doors or windows!

For the ultimate choice, we can colour match to any RAL or BS colour.
From **£72.69 per square metre** (including colour matched guides, box and end plates where applicable)

Depending on RAL colour selected there may be a minimum powder coating surcharge to be applied.

EXCEL UPGRADE

Face fit guide rails **£115.84 (pair)**
Reveal fit guide rails **£160.34 (pair)**

Secured by Design
Police Preferred Specification

LPCB CERTIFICATION
UKAS MANUFACTURING SYSTEMS
0007
Assessed to ISO 9001 & ISO 14001
Cert/LPCB ref. 306

SECEURODRIVE MOTOR

Supplied as standard: FOC

SOMFY MOTOR

Available with a surcharge: **£30 net**

CONTROL OPTIONS

Supplied as standard – choose ONE of the following:

SECEUROGLIDE | SECEUROSENSE PLUS

SOMFY | ROLLIXO

ALARM SURCHARGE

SECEUROSENSE PLUS
£86.75

SOMFY | ROLLIXO
Included

HALF BOX OPTIONS

300 mm box 90° fascia 350 mm box 90° fascia* 300 mm box 45° box cover

* 90° section of 350 mm box comes in 2 parts

Standard Colours	Overall Guide Width (mm)											Excel max. width		Headroom	Total Height
	FULL BOX	1500	2000	2500	3000	3500	4000	4600	5200	5400	5590				
	Guide Width*	75	75	75	75	75	75	75	90	90	90				
Guide Height (mm)	1900	1494	1684	1880	2081	2238	2557	2865	3194	3246	3298	300	2200		
	2150	1552	1719	1906	2118	2272	2590	2909	3244	3339		300	2450		
	2300	1588	1771	1934	2140	2307	2630	2949	3286	3572		300	2600		
	2500	1616	1839	1985	2273	2360	2683	3116	3426	3677		300	2800		
	3000	1830	2095	2339	2556	2663	2985	3339	3631			350	3350		
	3500	1997	2213	2474	2761	2966	3287					350	3850		
	3700	2164	2331	2607	2966	3266	3590					350	4050		

*SeceuroGlide Excel will always be supplied with 90 mm guides

Excel max. height

Woodgrain Colours	Overall Guide Width (mm)											Excel max. width		Headroom	Total Height
	FULL BOX	1500	2000	2500	3000	3500	4000	4600	5200	5400	5590				
	Guide Width*	75	75	75	75	75	75	75	90	90	90				
Guide Height (mm)	1900	1630	1866	2105	2350	2545	2908	3270	3652	3722	3961	300	2200		
	2150	1707	1923	2160	2422	2621	2989	3366	3762	3876		300	2450		
	2300	1752	1988	2204	2463	2681	3054	3439	3840	4148		300	2600		
	2500	1794	2075	2280	2625	2766	3145	3650	4029	4304		300	2800		
	3000	2045	2378	2694	2980	3147	3540	3978	4352			350	3350		
	3500	2246	2543	2885	3256	3719	4132					350	3850		
	3700	2449	2709	3076	3532	3909	4330					350	4050		

*SeceuroGlide Excel will always be supplied with 90 mm guides

Excel max. height

STANDARD COLOURS **5** YR

Powder coated guide rails, bottom slats and vision slats (where specified) to match the curtain colour are supplied as standard.

Box & End Plates: White or brown as standard. Other colour options are available at a surcharge of **£50.00 per metre** (includes end plates).

Guides Rails: Other non standard colours available at **£37.30 per pair**.

For Painted Woodgrains we will use these RAL numbers: Walnut RAL 8014, Natural Oak RAL 1011.

FOILED WOODGRAIN COLOURS **10** YR

Powder coated guide rails, bottom slats and vision slats (where specified) are supplied brown as standard.

Box: White or brown as standard. Other colour options are available at a surcharge of **£50.00 per metre**.

End Plates: Galvanised, white, brown or black as standard. Other colour options are available at a surcharge of **£24.96 per pair**.

Guides Rails: Other non standard colours available at **£37.30 per pair**.

DON'T FORGET!
We can match your existing doors or windows!

For the ultimate choice, we can colour match to any RAL or BS colour.
From **£72.69 per square metre** (including colour matched guides, box and end plates where applicable)

Depending on RAL colour selected there may be a minimum powder coating surcharge to be applied.

EXCEL UPGRADE

Face fit guide rails **£115.84 (pair)**
Reveal fit guide rails **£160.34 (pair)**

Secured by Design

Police Preferred Specification

Assessed to ISO 9001 & ISO 14001
Certified by LPCB ref. 306

UKAS MANAGEMENT SYSTEMS
0007

SECEURODRIVE MOTOR

Supplied as standard: FOC

SOMFY MOTOR

Available with a surcharge: **£30 net**

CONTROL OPTIONS

Supplied as standard – choose ONE of the following:

SECEUROGLIDE | SECEUROSENSE PLUS

SOMFY | ROLLIXO

ALARM SURCHARGE

SECEUROSENSE PLUS

£86.75

SOMFY | ROLLIXO

Included

FULL BOX OPTIONS

Optional Box

'Distance A' = 300 mm
'Distance B' = 350 mm*

* 90° section of 350 mm box comes in 2 parts



SeceuroGlide LT: Fir Green Colour Finish



SeceuroGlide LT: Black Colour Finish

The versatile roller garage door.

The entry level SeceuroGlide LT has been created as the perfect solution for those wanting to invest in the look and feel of the SeceuroGlide Original but without a need for all of the high security benefits and built-in noise reduction features offered by the standard SeceuroGlide product. Combining space saving vertical operation with the benefits of an insulated profile and the convenience of electrical operation the SeceuroGlide LT provides a made to measure solution to give lasting value to your property.

Profiles & Sizes

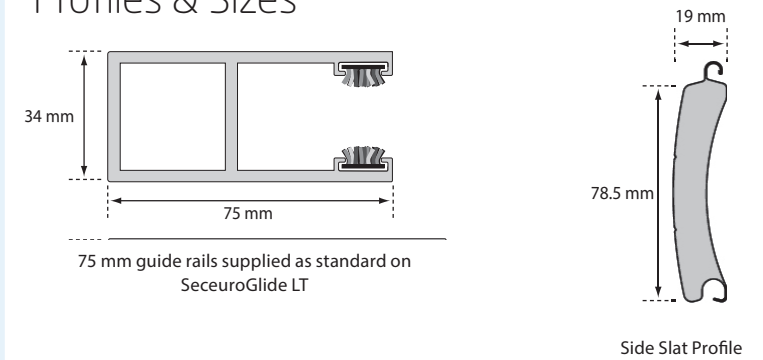

Aluminium End Plate
Standard, aluminium cast end plate.

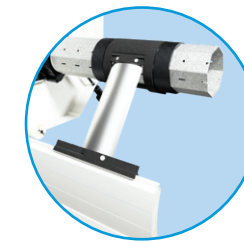

Standard Locking System
Plastic and steel locking straps secure your standard SeceuroGlide LT.



Endlocks
Endlocks used to secure the curtain in operation.

Overall Guide Width (mm)

Standard Colours	NO BOX	2000	2400	2600	3000	3600	4000	4500	4800	5200	Headroom	Total Height
	Guide Width	75	75	75	75	75	75	75	90	90		
Guide Height (mm)	1900	1491	1567	1600	1648	1744	1844	2104	2221	2266	300	2200
	2150	1522	1611	1652	1689	1825	2003	2261	2377	2490	300	2450
	2300	1593	1648	1706	1748	1892	2050	2311	2433	2537	300	2600
	2500	1636	1671	1754	1840	1919	2086	2341	2500		300	2800
	2650	1680	1744	1828	1880	1955	2121	2403	2519		300	2950

Overall Guide Width (mm)

Woodgrain Colours	NO BOX	2000	2400	2600	3000	3600	4000	4500	4800	5200	Headroom	Total Height
	Guide Width	75	75	75	75	75	75	75	90	90		
Guide Height (mm)	1900	1695	1831	1900	2067	2292	2428	2626	2737	2774	300	2200
	2150	1782	1933	2041	2212	2372	2572	2766	2836	2917	300	2450
	2300	1837	2015	2111	2236	2455	2686	2899	2961	3051	300	2600
	2500	1900	2103	2209	2382	2625	2826	2973	3098		300	2800
	2650	1960	2169	2281	2485	2654	2872	3023	3156		300	2950

STANDARD COLOURS



Powder coated bottom slats and vision slats (where specified) to match the curtain colour are supplied as standard.

End Plates: Aluminium, white or brown as standard. Other colour options are available at a surcharge of **£24.96 per pair**.

Guides Rails: White or Brown as standard. Other colour options are available at a surcharge of **£37.30 per pair**.

For Painted Woodgrains we will use these RAL numbers: Walnut RAL 8014, Natural Oak RAL 1011.



FOILED WOODGRAIN COLOURS

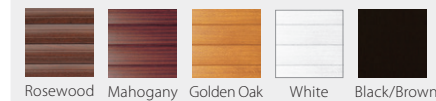

Powder coated guide rails, bottom slats and vision slats (where specified) are supplied brown as standard.

End Plates: Aluminium, white or brown as standard. Other colour options are available at a surcharge of **£24.96 per pair**.

Guides Rails: White or Brown as standard. Other colour options are available at a surcharge of **£37.30 per pair**.

Woodgrain finishes are supplied on one face only on brown slats as standard or white on request (Other base colours available at a cost of £36.31 per square metre NET).

Premier finishes are also available at a surcharge additional to the price shown of £17.58 per square metre.



SECEURODRIVE MOTOR

Supplied as standard: FOC **SeceuroDrive** Tubular Motor

SOMFY MOTOR

Available with a surcharge: **£30 net**

CONTROL OPTIONS

Supplied as standard – choose ONE of the following:

SECEUROGLIDE | SECEUROSENSE PLUS

SOMFY | ROLLIXO

ALARM SURCHARGE

SECEUROSENSE PLUS

£86.75

SOMFY | ROLLIXO

Included

Overall Guide Width (mm)

Standard Colours	HALF BOX	2000	2400	2600	3000	3600	4000	4500	4800	5200	Headroom	Total Height
	Guide Width	75	75	75	75	75	75	75	90	90		
Guide Height (mm)	1900	1521	1642	1637	1769	1943	2046	2200	2286	2294	300	2200
	2150	1562	1717	1777	1888	2039	2176	2355	2409	2444	300	2450
	2300	1604	1770	1824	1924	2127	2256	2425	2455	2509	300	2600
	2500	1662	1798	1886	1980	2192	2349	2476	2539		300	2800
	2650	1700	1818	1933	2056	2232	2414	2510	2634		300	2950

STANDARD COLOURS



Powder coated bottom slats and vision slats (where specified) to match the curtain colour are supplied as standard.

Box: White or Brown as standard. Other colour options are available at a surcharge of **£28.38 per metre**.

End Plates: Aluminium, white or brown as standard. Other colour options are available at a surcharge of **£24.96 per pair**.

Guides Rails: White or Brown as standard. Other colour options are available at a surcharge of **£37.30 per pair**.

For Painted Woodgrains we will use these RAL numbers: Walnut RAL 8014, Natural Oak RAL 1011.



Overall Guide Width (mm)

Woodgrain Colours	HALF BOX	2000	2400	2600	3000	3600	4000	4500	4800	5200	Headroom	Total Height
	Guide Width	75	75	75	75	75	75	75	90	90		
Guide Height (mm)	1900	1789	1943	2019	2204	2455	2608	2827	2951	3004	300	2200
	2150	1850	2046	2161	2350	2534	2799	3020	3106	3209	300	2450
	2300	1905	2119	2232	2430	2600	2851	3155	3232	3343	300	2600
	2500	1996	2175	2332	2521	2719	2915	3229	3371		300	2800
	2650	2057	2284	2403	2626	2826	3019	3279	3429		300	2950

FOILED WOODGRAIN COLOURS

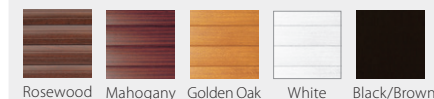

Woodgrain finishes are supplied on one face only on brown slats as standard or white on request (Other base colours available at a cost of **£36.31 per square metre NET**).

Premier finishes are also available at a surcharge additional to the price shown of **£17.58 per square metre**.

Powder coated guide rails, bottom slats and vision slats (where specified) are supplied brown as standard.

Box: White or brown as standard. Other colour options are available at a surcharge of **£28.38 per metre**.

End Plates: Aluminium, white or brown as standard. Other colour options are available at a surcharge of **£24.96 per pair**.

Guides Rails: White or Brown as standard. Other colour options are available at a surcharge of **£37.30 per pair**.



SECEURODRIVE MOTOR

Supplied as standard: FOC SeceuroDrive Tubular Motor

SOMFY MOTOR

Available with a surcharge of **£30 net**

CONTROL OPTIONS

Supplied as standard – choose ONE of the following:

SECEUROGLIDE | SECEUROSENSE PLUS

SOMFY | ROLLIXO

ALARM SURCHARGE

SECEUROSENSE PLUS

£86.75

SOMFY | ROLLIXO
Included

HALF BOX OPTIONS

300 mm box 90° fascia

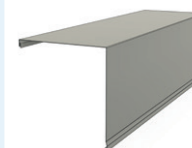

300 mm box 45° box cover

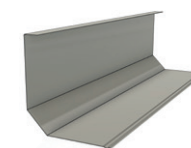

BOX MADE UP AS STANDARD

Boxes for SeceuroGlide LT come made up as standard.

If you do not wish to take advantage of this manufacturing process, there will be a **£15 net discount**.

Overall Guide Width (mm)

Standard Colours	FULL BOX	2000	2400	2600	3000	3600	4000	4500	4800	5200	Headroom	Total Height
	Guide Width	75	75	75	75	75	75	75	90	90		
Guide Height (mm)	1900	1544	1668	1718	1864	2057	2172	2396	2438	2460	300	2200
	2150	1602	1785	1845	1997	2189	2303	2506	2543	2587	300	2450
	2300	1640	1830	1903	2057	2240	2382	2580	2609	2675	300	2600
	2500	1679	1847	1934	2094	2305	2475	2616	2690		300	2800
	2650	1722	1892	1983	2149	2345	2524	2638	2709		300	2950

Overall Guide Width (mm)

Woodgrain Colours	FULL BOX	2000	2400	2600	3000	3600	4000	4500	4800	5200	Headroom	Total Height
	Guide Width	75	75	75	75	75	75	75	90	90		
Guide Height (mm)	1900	1853	2021	2104	2303	2425	2742	2977	3112	3179	300	2200
	2150	1906	2105	2246	2353	2501	2932	3171	3267	3383	300	2450
	2300	1956	2167	2317	2415	2564	3048	3304	3392	3517	300	2600
	2500	2013	2240	2416	2579	2649	3128	3379	3530		300	2800
	2650	2298	2447	2488	2739	2999	3238	3428	3588		300	2950

STANDARD COLOURS



Powder coated bottom slats and vision slats (where specified) to match the curtain colour are supplied as standard.

Box: White or Brown as standard. Other colour options are available at a surcharge of **£50.00 per metre**.

End Plates: Aluminium, white or brown as standard. Other colour options are available at a surcharge of **£24.96 per pair**.

Guides Rails: White or Brown as standard. Other colour options are available at a surcharge of **£37.30 per pair**.

For Painted Woodgrains we will use these RAL numbers: Walnut RAL 8014, Natural Oak RAL 1011.



FOILED WOODGRAIN COLOURS

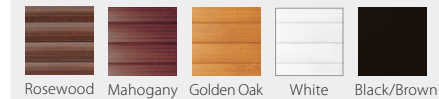

Powder coated guide rails, bottom slats and vision slats (where specified) are supplied brown as standard.

Box: White or brown as standard. Other colour options are available at a surcharge of **£50.00 per metre**.

End Plates: Aluminium, white or brown as standard. Other colour options are available at a surcharge of **£24.96 per pair**.

Guides Rails: White or Brown as standard. Other colour options are available at a surcharge of **£37.30 per pair**.



SECEURODRIVE MOTOR

Supplied as standard: FOC **SeceuroDrive** Tubular Motor

SOMFY MOTOR

Available with a surcharge: **£30 net** **somfy**

CONTROL OPTIONS

Supplied as standard – choose ONE of the following:

SECEUROGLIDE | SECEUROSENSE PLUS

SOMFY | ROLLIXO

ALARM SURCHARGE

SECEUROSENSE PLUS

£86.75

SOMFY | ROLLIXO Included

FULL BOX OPTIONS

'Distance A' = 300 mm

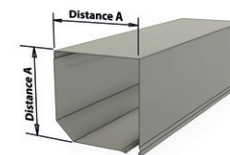

BOX MADE UP AS STANDARD

Boxes for SeceuroGlide LT come made up as standard.

If you do not wish to take advantage of this manufacturing process, there will be a **£15 net discount**.



SeceuroGlide Compact: White Colour Finish



SeceuroGlide Compact: White Colour Finish

SeceuroGlide Compact internal/external fitting roller garage door.

The SeceuroGlide Compact has been developed especially for garages with limited headroom. SeceuroGlide Compact's insulated aluminium slats are narrower than those used for the SeceuroGlide allowing a tighter, smaller coil which requires just 8" (205 mm) clearance above the opening height. An extensive range of sizes also means openings of up to 3000 mm wide (Overall Guide Width) can be accommodated.

Profiles & Sizes

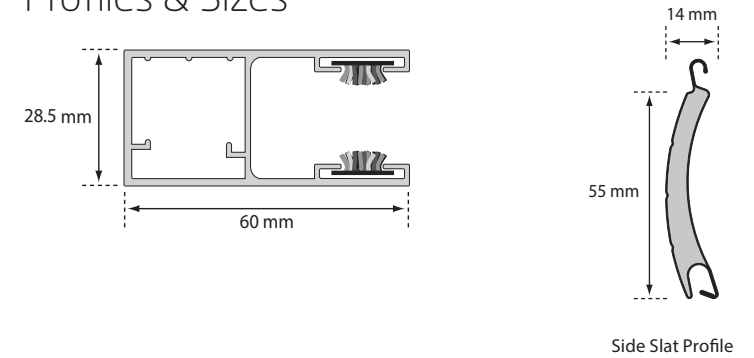

End Plate

The Compact features a rugged locking system for peace-of-mind security.

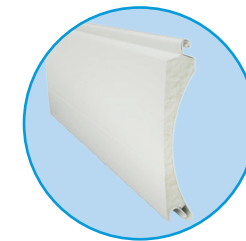

Slimline Design

The Compact's slimline slat is fully insulated, yet has an exposed face just 55 mm high.

Overall Guide Width (mm)

Standard Colours	Overall Guide Width (mm)			Headroom	Total Height
	HALF BOX	2000	2500		
	Guide Width	60	60	60	
	Guide Height (mm)	1900	1662	1765	205
	2150	1691	1784	205	2355
Overall Guide Width (mm)			Headroom	Total Height	
FULL BOX	2000	2500			3000
Guide Width	60	60	60		
Guide Height (mm)	1900	1707	1804	205	2105
	2150	1731	1832	205	2355

Overall Guide Width (mm)

Woodgrain Colours	Overall Guide Width (mm)			Headroom	Total Height
	HALF BOX	2000	2500		
	Guide Width	60	60	60	
	Guide Height (mm)	1900	1844	1994	205
	2150	1894	2052	205	2355
Overall Guide Width (mm)			Headroom	Total Height	
FULL BOX	2000	2500			3000
Guide Width	60	60	60		
Guide Height (mm)	1900	1879	2022	205	2105
	2150	1924	2081	205	2355

STANDARD COLOURS



Powder coated bottom slats to match the curtain colour are supplied as standard.

Half Box: White, Brown or Fir Green as standard. Other colour options are available at a surcharge of **£28.38 per metre**.

Full Box: White, Brown or Fir Green as standard. Other colour options are available at a surcharge of **£50.00 per metre**.

End Plates: White, Brown or Fir Green as standard. Other colour options are available at a surcharge of **£24.96 per pair**.

Guides Rails: White, Brown or Fir Green as standard. Other colour options are available at a surcharge of **£37.30 per pair**.

FOILED WOODGRAIN COLOURS

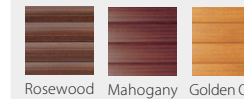

Powder coated guide rails and bottom slats are supplied brown as standard.

Half Box: White, Brown or Fir Green as standard. Other colour options are available at a surcharge of **£28.38 per metre**.

Full Box: White, Brown or Fir Green as standard. Other colour options are available at a surcharge of **£50.00 per metre**.

End Plates: White, Brown or Fir Green as standard. Other colour options are available at a surcharge of **£24.96 per pair**.

Guides Rails: White, Brown or Fir Green as standard. Other colour options are available at a surcharge of **£37.30 per pair**.

SECEURODRIVE MOTOR

Supplied as standard: FOC **SeceuroDrive**
Tubular Motor

SOMFY MOTOR

Available with a surcharge of **£30 net** **somfy**

CONTROL OPTIONS

Supplied as standard – choose ONE of the following:

SECEUROGLIDE | SECEUROSENSE PLUS

SOMFY | ROLLIXO

ALARM SURCHARGE

SECEUROSENSE PLUS

£86.75

SOMFY | ROLLIXO
Included

HALF BOX OPTIONS

205 mm box 90° fascia

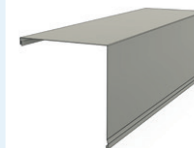

FULL BOX OPTIONS

'Distance A'
= 205 mm

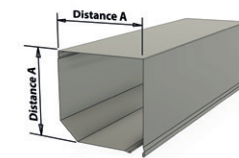



SeceuroGlide Manual: Light Grey Colour Finish



SeceuroGlide Manual: Anthracite Colour Finish

SeceuroGlide Manual the only insulated manual roller garage door on the market.

Developed to the same high standards and build quality as the SeceuroGlide range, SeceuroGlide Manual offers the ideal solution for applications where electricity is not available. The SeceuroGlide Manual has been engineered with ease of use in mind to provide the smoothest operation, whilst still offering the high levels of security and insulation.

Profiles & Sizes

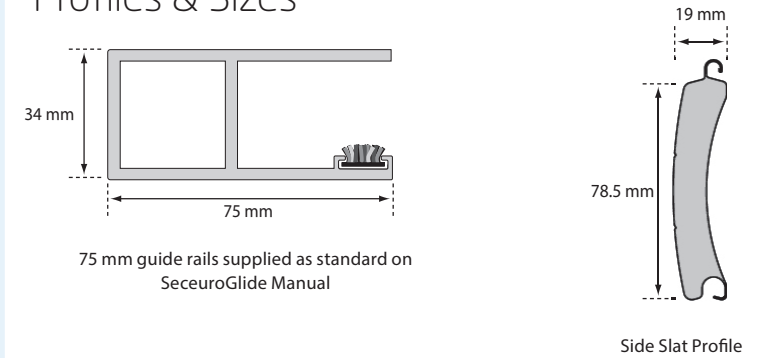

Smooth Operation
The rolling bracket ensures smooth operation and reduces wear.



Strengthening Bottom Slat
Patented bottom slat profile provides strength and aids operation.



Insulated Slats
Foam filled aluminium slats.

Overall Guide Width (mm)

Standard Colours	Overall Guide Width (mm)						Headroom	Total Height
	NO BOX	1000	1500	2000	2500	3000		
	Guide Width	75	75	75	75	75		
Guide Height (mm)	1900	901	1052	1204	1363	1532	300	2200
	2150	947	1113	1240	1392	1567	300	2450
	2300	1001	1148	1297	1419	1580	300	2600

STANDARD COLOURS



Burgundy (RAL 3004)	Navy Blue (RAL 5011)	Light Beige (BS 08B17)	Brown (RAL 8014)	Fir Green (RAL 6009)	Black (RAL 9005)
White (RAL 9016)	Silver Metallic (RAL 9006)	Anthracite (RAL 7016)	Graphite	Heritage Green (RAL 6021)	Ivory (RAL 1015)
Light Grey (RAL 7038)	Duck Egg Blue	Chartwell Green			

Powder coated guide rails and bottom slats to match the curtain colour are supplied as standard.

End Plates: Aluminium, white or brown as standard. Other colour options are available at a surcharge of **£24.96 per pair**.

Guides Rails: Other non standard colours available at **£37.30 per pair**.

PLEASE NOTE: Painted Woodgrains and Foiled Woodgrain Colours are not available on our SeceuroGlide Manual Garage Door.

KEY OPERATION

The key operated lock is located in the middle of the door. Integrated handles are located in the middle and at the bottom for convenient operation from inside or outside the garage.



In partnership with the Weather Defender

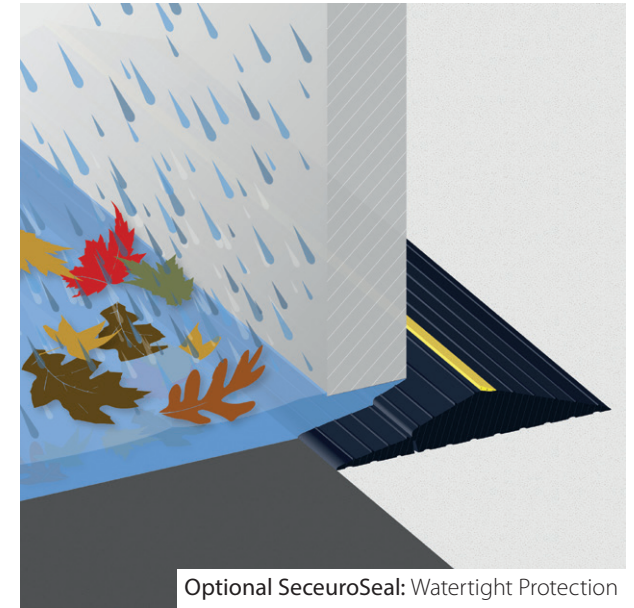

Optional SeceuroSeal: Watertight Protection

SECEUROSEAL

SeceuroSeal provides a watertight seal and a physical barrier to prevent water and debris entering the garage. Particularly useful for garages with uneven floors, or those that lie at the bottom of a sloping driveway, SeceuroSeal is fitted on the ground underneath the door and has been developed to ensure garages are kept dry and clean, even in the worst of the British weather.

SeceuroSeal is supplied flat in pre-cut lengths for **£22.16 per metre**. SeceuroSeal Adhesive (290ml) is available for **£14.43 each**.



SeceuroGlide Vertico: White Colour Finish



SeceuroGlide Vertico: White Colour Finish

Our lateral running door offers a unique and stylish solution for any garage design.

The Vertico makes the most of your garage space and creating a design feature for your home. Vertico is made from aluminium foam filled slats which link together to ensure exceptionally smooth operation and insulation, making the Vertico an ideal choice for heated garages and workshops. The vertical design offers partial opening ensuring minimal heat-loss and provides a convenient solution for pedestrian or bicycle access.

Configuration examples

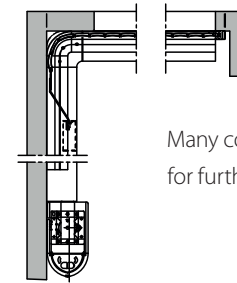

Many configurations are possible, for further examples, please scan the QR code.



Space Saving
Park next to door without affecting the door's operation.



Headroom
Only 50 mm of headroom required.

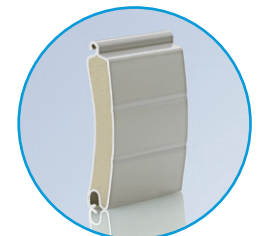

Insulated Slats
CFC-free foam-filled aluminium slat design.

Unit Width (mm)

Standard Colours	Unit Height (mm)	Unit Width (mm)																				
		2000	2200	2400	2600	2800	3000	3200	3400	3600	3800	4000	4200	4400	4600	4800	5000	5200	5400	5600	5800	6100
Standard Colours	2000	3498	3640	3712	3785	3936	4079	4225	4297	4443	4517	4661	4802	4873	5014	5090	5231	5373	5444	5647	5849	6151
	2200	3573	3714	3788	3862	4003	4142	4287	4360	4502	4572	4713	4854	4923	5059	5131	5270	5410	5481	5681	5884	6186
	2400	3783	3929	4003	4075	4225	4372	4520	4589	4739	4816	4958	5111	5184	5335	5410	5558	5709	5784	5996	6213	6534
	2600	3909	4057	4127	4198	4341	4485	4631	4701	4848	4920	5066	5214	5286	5429	5506	5652	5798	5872	6091	6305	6633
	2800	4137	4287	4360	4434	4583	4732	4879	4955	5104	5174	5325	5477	5553	5702	5779	5928	6084	6156	6386	6610	6954
	3000	4297	4443	4517	4588	4735	4879	5024	5098	5244	5318	5464	5605	5674	5815	5890	6033	6173	6243	6476	6710	7054

STANDARD COLOURS



Creamy White, Aluminium Grey and Metallic Grey are also available – please enquire.

Top rail: White, Brown, Silver Metallic

VERTICO ACCESSORIES AND EXTRAS

IMAGE	DESCRIPTION	PROFILE	PRICE (£)	IMAGE	DESCRIPTION	PROFILE	PRICE (£)
ACCESSORIES				ACCESSORIES			
	Emergency safety release from outside, lockable per unit.	per unit	148.26		Additional hand transmitter (HS 2-M, 2 command 868 MHz)	per unit	108.95
	170x40mm extruded aluminium corner cover for reveal fix installation	per vertical M	43.62		Additional hand transmitter (HS 4-M, 4 command, 868 MHz)	per unit	182.27
	Window opening 50x150mm, Two super-imposed windows possible per slat CD77/SF, vision slat curtain with plexiglass inserts. Recommendation: Light-band/window opening: installation in every fourth slat in horizontal direction.	per window	34.94		Digital 526, Radio-Code button, 3 channel with cover	per unit	361.39
	Coating design package: Special RAL coatings for guide channel, covers, turn radius and optional screen.	per unit	366.41		Multi-function interior push button station with system plug. Functions: – Door status display, open-closed – Permanent lighting on-off – Operator, open-stop-close	per unit	139.76
					Surface-mounted key operated switch with system plug (29002/M) Flush-mounted version (29003/M)	per unit	138.17

SUPPLIED AS STANDARD WITH:

- Remote control motor unit including two transmitters
- Emergency unlocking from inside
- Galvanised floor rail

TECHNICAL OVERVIEW:

- Space requirement in the lintel area can be minimised to 50 mm
- Maximum unit width: 6100 mm
- Maximum unit height: 3050 mm
- Bottom track only 25 mm high
- Certified by TUV (Technical Inspection Authorities), produced according to DIN-EN safety standards

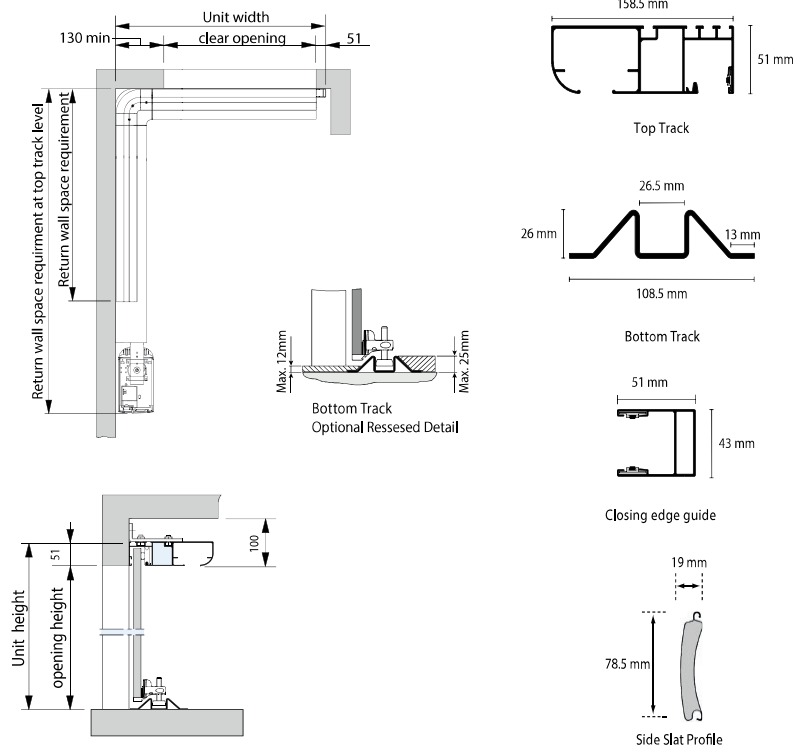

NOTES

COMPLIANCE WITH CURRENT LEGISLATION

- To ensure compliance with the Construction Products Regulation SeceuroGlide Compact must be installed with either a SeceuroSense Plus / Rollix remote control or a 'hold-to-run' switch or key switch.
- We recommend the use of photocells in addition to the standard bottom slat sensor in garages where a vehicle will be parked close to the door. Moreover, where a door opens directly onto a pavement or in a public area, a combination of bottom slat sensor and photocells is a statutory requirement.
- Antidrop devices are supplied when required at no extra cost.
- If ordering photocells retrospectively, the panel will need to be checked for compatibility. For more information please contact our Technical Support line on 01524 772 400.

COLOURS AND POWDER COATING

- Powder coated boxes, guides, bottom and locking slats may be a slightly different shade to the curtain.
- Other Renolit woodgrain finishes are available at the same cost as Mahogany, Rosewood, Golden Oak, White and Black/Brown, however longer lead times may apply. Please contact Customer Services for further details on 01524 772 400.
- SeceuroGlide Compact textured woodgrain doors are supplied with matching bottom slats and brown inner face, guides, end plates and half box as standard.
- SeceuroGlide Manual is NOT AVAILABLE in Woodgrain or Painted Woodgrain
- For woodgrain effect doors, any vision/vented slats will be supplied in a solid colour nearest to the colour of the woodgrain. Golden Oak will be supplied with brown. Vision slats are NOT available on the Compact or the Manual.
- Marking may occur at the top of the concave (coil) side of the curtain over time. This is unavoidable and due to prolonged contact with the locking system.
- Whilst the garage door profiles are primed and coated for the external environment – any doors fitted in coastal environments may be at risk of deterioration due to the weather conditions. Ensure you keep your door clean and follow the instructions for cleaning the door in the operating and maintenance instructions.
- Any Matched RAL colour garage doors are finished in a low gloss finish which is similar in gloss level to the pre-coated colours.

FITTING

- SeceuroGlide Excel must always be fitted internal face fitted / reveal fitted.
- When fitted externally SeceuroGlide Original will always be supplied with a full box.
- SeceuroGlide Compact external comes supplied with a full box.
- SeceuroGlide Manual can only be fitted internally.
- SeceuroGlide Manual is NOT AVAILABLE with box lid or fascia.
- A low level override option not available for SeceuroGlide Excel. Where the garage door is the only means of exit from a garage, a low level override can be supplied, however this will affect the Level 1 certification and SBD certification will not be supplied.
- If vented slats are selected as an option on SeceuroGlide Original or Excel, they will be supplied, however, this will affect the Level 1 and SBD accreditation and the security certification will not be supplied.
- Unless requested otherwise, when installed internally, tubular motors will be fitted on the left hand side of each door (when viewed from inside the garage looking out). Alternatively, unless requested otherwise, when installed externally, tubular motors will be fitted on the left hand side of each door (when viewed from outside the garage looking in).

SECURITY AND RESISTANCE TO HIGH WINDS

SeceuroGlide Original and Excel doors tested to a minimum Class 2 wind resistance classification, which is equivalent to 59mph winds (Force 10 Storm).

Please note: if a door is situated in an exposed location and subjected to very high winds and driving rain, the SeceuroGlide range does not guarantee against water ingress. As part of the product's testing for the CE marking, the product has not been tested against this and as such is classified as NPD (No Performance Declared)

OPTIONS & ACCESSORIES

IMAGE	DESCRIPTION	PROFILE	STOCK CODE	PRICE (£)
SECEUROSENSE HAND TRANSMITTERS				
	Plus 3 channel transmitter	each	EC71303	75.62
	Chrome 4 channel transmitter	each	EC71404	75.62
	Chrome Ellipse 4 channel transmitter	each	EC71004	75.62
	Chrome Deluxe 2 channel transmitter	each	EC71602	86.42
	Chrome Deluxe 4 channel transmitter	each	EC71604	86.42
	Smooth black 2 channel transmitter	each	EC71202	75.62
	Smooth black 4 channel transmitter	each	EC71204	75.62
	Smooth white 2 channel transmitter	each	EC71102	75.62
	Smooth white 4 channel transmitter	each	EC71104	75.62
	S/Sense Black Deluxe 2 channel transmitter	each	EC71702	75.62
	S/Sense Black Deluxe 4 channel transmitter	each	EC71704	75.62

IMAGE	DESCRIPTION	PROFILE	STOCK CODE	PRICE (£)
SECEUROSENSE WALL SWITCHES				
	4 channel black wall transmitter	each	EC73104	96.75
	4 channel white wall transmitter	each	EC73004	96.75
	4 channel stainless steel cover for wall transmitter	each	EC73000	40.04
	Wireless keypad	each	EC70300	231.32
SECEUROSENSE BIDIRECTIONAL CONTROLS				
	Smooth black 4 channel bi-directional transmitter	each	EC75104	91.19
	Smooth white 4 channel bi-directional transmitter	each	EC75004	91.19
	4 channel black bi-directional wall switch	each	EC74104	139.01
	4 channel white bi-directional wall switch	each	EC74004	139.01
SECEUROSENSE LIGHTING				
	Lighting strip external 1000 mm	each	EC76000	249.12
	Lighting strip external 2 x 1000 mm	each	EC77000	326.97
	Lighting Aluminium Cover 2000 mm	each	EC78000	92.31

OPTIONS & ACCESSORIES

















IMAGE	DESCRIPTION	PROFILE	STOCK CODE	PRICE(£)
SECEUROSENSE ACCESSORIES & OPTIONS				
	Tubular Motor Test Lead	each	EC40900	95.92
	Alarm Kit for SeceuroSense Plus	each	EC72300	86.75
	SeceuroSense Hard Wired Magnets (for uneven floors)	each	EC72600	52.27
	Upgrade to SeceuroSense External Bottom Slat Transmitter	each	YSGACCS1 EXTERNL	128.11
	SeceuroSense Photocell & Reflector	each	EC70500	95.38
ROLLIXO ACCESSORIES & OPTIONS				
	Somfy Smooove Origin RTS	each	EC37700	55.61
	Photocell cover	each	EC359T0	18.91
	Photocell and reflector	each	SG102P1	95.65
	Rollixo alarm kit	each	EC41001	22.25
	Keygo transmitters	each	SG100P0	76.97
	Situlo 1 RTS Pure II Situlo 1 RTS Iron II Situlo 1 RTS Natural II Situlo 1 RTS Artic II	each	EC37800 EC37801 EC37802 EC37803	53.34 104.21 108.80 108.80
	Situlo 5 RTS Pure II Situlo 5 RTS Iron II Situlo 5 RTS Natural II Situlo 5 RTS Artic II	each	EC37900 EC37901 EC37902 EC37903	77.59 104.66 139.58 139.58
	Somfy RTS Standard Receiver	each	SG103P0	88.54
	Batteries for Keygo Transmitter	each	EC36100	5.49
	Rollixo magnet	each	BS680M0	26.12
	Rollixo wireless keypad	each	SG101P0	130.12

IMAGE	DESCRIPTION	PROFILE	STOCK CODE	PRICE (£)
OTHER CONTROL OPTIONS				
	Dual Pole Surface Mounted Geba Keyswitch Keyed Alike	each	EC38103	81.22
	Dual Pole Surface Mounted Geba Keyswitch Keyed Different	each	EC38102	80.44
	SO12 Flush Front Plate	each	EC38104	7.23
OTHER OPTIONAL EXTRAS				
	Fitted manual override lock (SeceuroGlide Compact Only)	each	YSGACCS1 O/R LOK	137.82
	90 mm guides (upgrade from 75 mm guides)	per door	YSGACCS1 90 GUIDE	78.35
	SLOPING BOTTOM SLAT: Not available on Excel (please use order form) Overall door width from 0 to 5000 mm <i>Online prices per linear metre @ £115.44 when specified with door</i>	per linear metre	YACCS SLOPE	119.28
	SeceuroGlide Vision Slat (punched and glazed) Available Inline or Brick Bond	per linear metre	YSGACCS1 VISION	16.63
	SeceuroGlide Vented Slat* *Not available in Renolit or Painted Woodgrain finishes	per linear metre	SL777VS VENTED	51.13
	300 mm 90° fascia box support (4 required up to 3000 mm, 6 required – 3001 to 5400 mm)	each	BX000B0	7.36
	Emergency low level external manual override kit	each	MT120M1	200.16
	Loose manual override exit lock	each	MT018A1	56.87
	SeceuroSeal	per metre	BS810B0	22.16
	SeceuroSeal Adhesive (290ml)	each	BS810B1	14.43

OPTIONS & ACCESSORIES

IMAGE	DESCRIPTION	PROFILE	STOCK CODE	PRICE (£)
SECEUROGLIDE & SECEUROGLIDE COMPACT LATH REPLACEMENTS				
	SeceuroGlide cut Slat (Standard colours)	per metre	YSL770A1	11.56
	SeceuroGlide cut Slat (Woodgrain colours)	per metre	YSL770A2	18.47
	SeceuroGlide Compact cut Slat (Standard colours)	per metre	YSL30A1	5.37
	SeceuroGlide Compact cut Slat (Woodgrain colours)	per metre	YSL30A2	17.76
SECEUROGLIDE CURTAINS				
	SECEUROGLIDE READY MADE CURTAIN (The surcharge does not include the cost of safety edge this needs to be added on (cut out for the RDU is included if needed)			
	Standard colours Woodgrain	per metre square	SGLIDE CD77 CURT WOODGRAIN	162.81 203.44
	SECEUROGLIDE COMPACT READY MADE CURTAIN (The surcharge does not include the cost of safety edge this needs to be added on (cut out for the RDU is included if needed)			
	Standard colours Woodgrain	per metre square	CURT CD300 WOODGRAIN	140.29 176.29
ALUMINIUM BOX AND ANGLES				
	30 x 20 Aluminium L Section Angle (Mill Finish) 30 x 20 Aluminium L Section Angle Powder Coated (White) 30 x 20 Aluminium L Section Angle Powder Coated (Brown)	per metre	YBS300E0 YBS300E1 YBS300E2	10.36
	50 x 20 Aluminium Box Section/Packer (Mill Finish) 50 x 20 Aluminium Box Section/Packer Powder Coated (White) 50 x 20 Aluminium Box Section/Packer Powder Coated (Brown)	per metre	YBS520E0 YBS520E1 YBS520E2	19.17
	50 x 50 Aluminium Box Section/Packer (Mill Finish) 50 x 50 Aluminium Box Section/Packer Powder Coated (White) 50 x 50 Aluminium Box Section/Packer Powder Coated (Brown)	per metre	YBS550E0 YBS550E1 YBS550E2	24.00
TOUCH-UP PAINT POT & PEN				
	TOUCH-UP PAINT POT Anthracite (RAL7016), Black (RAL9005), Brown (RAL8014), Burgundy (RAL3004), Duck Egg Blue, Chartwell Green (BS14C35), Fir Green (RAL6009), Graphite (RAL7024), Heritage Green (RAL6021), Ivory (RAL1015), Light Beige (BS08B17), Light Grey (RAL7038), Navy Blue (RAL5011), Silver Metallic (RAL9006), White (RAL9016)	each	PC500XX	6.29
	TOUCH-UP PAINT PEN Anthracite (RAL7016), Black (RAL9005), Brown (RAL8014), Burgundy (RAL3004), Light Beige (BS08B17), Light Grey (RAL7038), Silver Metallic (RAL9006)	each	PC502PX	25.24
COVERCAPS				
	13MM COVERCAPS Brown, Black, Blue, Cream, Dark Grey, Grey, Heritage Green, Red, White	each	GU010XX	0.16

IMAGE	DESCRIPTION	PROFILE	STOCK CODE	PRICE (£)
SUNDRY SPARES				
	Sticky Backed Brush Strip (Monkey Fur)	per metre	GU031B0	4.45
SPARES AND UPGRADES				
	SeceuroSense Plus Receiver Unit – Wireless	each	EC89100	191.61
	SeceuroSense Plus Receiver Unit – Wired	each	EC89200	191.61
	SeceuroSense Plus Receiver Unit – Wireless IP/External BST	each	EC89300	191.61
	SecuroSense Bottom Slat Transmitter 1.5v	each	EC75100	121.22
	Duracell Batteries for SeceuroSense Bottom Slat Transmitter 1.5v	each	EC75101	2.00
	3.6v Lithium Battery For SeceuroSense (2pk)	each	EC71101	28.92
	Radio Card for 3.6v BST	each	EC79900	129.92
	Radio Card for 3.6/1.5v BST	each	EC79800	129.92
	Rollixo Receiver & 2 Keygo Transmitters	each	EC46000	348.82
	Rollixo XSE Bottom Slat Transmitter	each	B5680B0	121.22
	Replacement Light Bulb for SeceuroSense Courtesy Light	each	EC72500	4.45
	Batteries for SeceuroSense Transmitters (CR2032)	each	EC36101	5.56
UPGRADE KITS				
	SeceuroSense Plus Wireless Upgrade Kit	each	EC69903	359.71
	SeceuroSense Plus Wired Upgrade Kit	each	EC69902	359.71
	Somfy Rollixo Garage Door Remote Control Upgrade Kit	each	EC49900	364.78
	AEGDW Bottom Slat	per metre	YBS005E1	28.21
	Triple Chamber Rubber Seal	per metre	B5730B0	17.79
	Radio Card & BST Upgrade Kit	each	EC99000	254.77

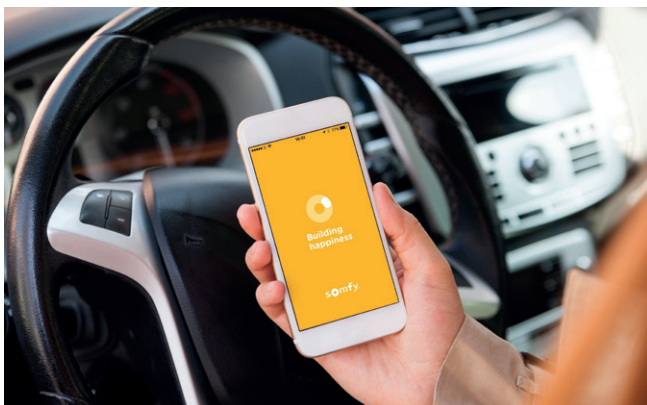

With Home Automation you can put yourself in control of securing your world, even when you are miles away from home.

A SMART WAY OF LIVING

Monitor and operate lights, home surveillance and garage doors with your smartphone or tablet, for great peace of mind from anywhere in the world. Personal to You With the bespoke style of your SeceuroGlide garage door, you can adjust everything about the Home Automation system to accommodate your personal preferences.

CONVENIENT FROM THE BEGINNING

Your customers will be able to secure their home with the touch of a button via Somfy Connexoon, and if they upgrade to a Somfy TaHoma hub they can add extras in the future, such as surveillance cameras, motion detectors and climate control.

WHICH SYSTEM IS FOR ME?

- Connexoon is a home automation starter kit which can control your garage door and fulfil basic commands.
- TaHoma is a fully integrated home automation system, enabling you to take full control of your garage, blinds, lighting, heating and security system.

KEY FEATURES

- Control your home from anywhere using TaHoma
- Improve security and safety at home
- Geo-Location ringfencing (Connexoon only)
- Multi-function control
- Integrate with your family routine
- Create scenarios for different requirements throughout your home

COMPATIBLE DEVICES

Your Home Automation with SWS UK and Somfy can be compatible with multiple devices, including:



SOMFY HOME AUTOMATION ACCESSORIES <i>(more options available online)</i>				
IMAGE	DESCRIPTION	COMPATIBLE WITH:	STOCK CODE	PRICE (£)
	Connexoon RTS	N/A	EC462CX	186.18
	TaHoma	N/A	EC461TM	382.17
	Garage Door Sensor	TaHoma	EC465GD	175.27
	RTS Plug	TaHoma Connexoon	EC466PL	38.42
	Water Sensor	TaHoma	EC467WS	140.21
	Indoor Camera	Somfy Protect app	EC470IC	292.12
	Indoor Siren	TaHoma	EC473IS	132.43
	Outdoor Motion Sensor	TaHoma	EC474OM	529.73
	Smoke Detector	TaHoma	EC481SM	132.43
	Temperature Sensor	TaHoma	EC482TS	175.93
	Outdoor Camera (White)	Somfy Protect app	EC471CW	565.75

DELIVERY, PACKING & WARRANTIES

DELIVERY SERVICE

Our standard delivery service covers England and Wales weekly, Scotland and Ireland fortnightly.

Pricing includes delivery on all orders over £400 on our standard weekly service to England and Wales. Additional chargeable deliveries can often be arranged with Customer Services. We also offer home/site delivery service options with one or two men depending on the size of delivery and site conditions.

Delivery confirmations for our own dedicated service will be emailed or texted the previous afternoon if AM or PM the following working day. Please ensure an email address and/or mobile number is supplied on your order.

DELIVERY CHARGES

	£
Over £400 net on standard run	Nil
Under £400 net on standard run	£44.50
All orders required on a different day to standard delivery run	POA
Collection from distribution depot	Nil
Pre agreed time slot for standard deliveries	POA
Site delivery charge one man offload	£65.50 extra
Site delivery charge two man offload	£107.50 extra
Redelivery of goods	£41.00 extra
Deliveries to Scotland	£39.00 per drop
Deliveries to Ireland	POA

CARRIER SERVICES PRICE

	£
Component items up to 5 kg (Including singular tube motors)	£13.85
Component items up to 20 kg	£33.80
Delivery & packaging of fragile items over 20 kg	£75.00
Pre 10.30 am	£43.00 extra
Pre noon	£31.70 extra
Saturday pre noon	£53.30 extra

Additional surcharges apply on the following:

Ireland, Isle of Man, Channel Islands & Scottish offshore	POA
Isle of Wight, Grampian & Highlands	POA
Devon & Cornwall	£14.40

For urgent orders in certain areas of the country, collection is possible from our 3 distribution depots (must be collected within 24 hours):

South (Heathrow)

Units 2, 3 & 4, Lakeside Industrial Estate,
Lakeside Road, Colnbrook SL3 0ED

Midlands (Willenhall)

DX Freight, Unit 1 Bays 1, 2, 3 East Acre,
Off Long Acre, Willenhall WV13 2JZ

Bristol

Jupiter Road, Patchway, Bristol BS34 5BW

COMPONENT ORDERS

All small component orders required next day must be received by 2 pm the day before delivery. Orders placed on a Friday must be received by 12 noon for delivery on Monday.

If you require powder-coated items, please allow an additional 24 hours at least from the receipt of order. Items for assembly need to be booked in for manufacturing – for example complete shutter curtains. Please allow a minimum of three working days depending on the delivery method.

Regrettably it is not possible to send items over 5 m in length by overnight carriers.

IMPORTANT DELIVERY NOTE

The most cost effective and safest way of delivering orders is via our own transport. Please try to tie orders in with your normal delivery runs wherever possible.

In the event of using a carrier, we need to use reinforced packaging.

CRATE CHARGES

We can offer delivery by crate on a POA basis. Please speak to Customer Services.

SECEUROGLIDE COMPLIANCE WITH THE LATEST CE STANDARDS

The SeceuroGlide range is fully compliant with the latest European product directives and standards including BSEN 13241-1 applicable from the 1st May 2005.

APPROVED SUPPLIER:

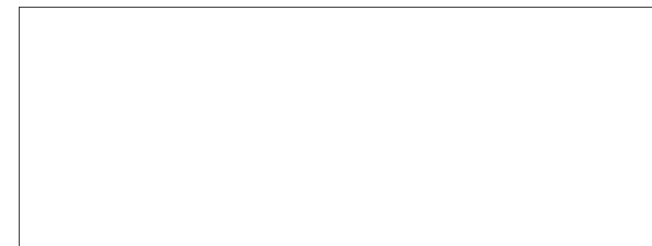

SECEUROGLIDE PEACE-OF-MIND WARRANTIES

SeceuroGlide Excel, SeceuroGlide Original, SeceuroGlide LT, SeceuroGlide Compact and SeceuroGlide Manual are guaranteed against defect of material or workmanship by SWS UK with a parts only warranty for a period of 5 years from the date of purchase, subject to correct installation, maintenance and operation. Our standard SeceuroDrive motor carries a 7 year warranty, subject to registration (<https://warranty.sws.co.uk>) within 3 months of installation (excluding LT). If a SeceuroDrive motor is paired with a SeceuroSense Plus receiver it will also be eligible for a 7 year warranty. In addition, Rosewood, Mahogany, Golden Oak, White, Black / Brown and our full range of Renolit wood effect finishes carry a limited 10 year guarantee on the slat finish.

SeceuroGlide Vertico is guaranteed for a period of 2 years from the date of purchase, subject to correct installation, maintenance and operation.

Please note darker coloured double doors that are exposed to significant direct sunlight may be susceptible to expansion which may interfere with the operation of the door.

SECEUROGLIDE EXTREME WEATHER CONDITIONS

High winds and high temperatures can cause increased deflection of the door. It is the installer's responsibility to ensure that the door is packed off the wall sufficiently to allow for door movement during these extreme weather conditions.

SWS UK is proud to be an official supporting supplier of The Association Of Garage Door Specialists. In line with SWS UK's policy of continuous product development, we reserve the right to make changes without prior notification. All information is believed correct at the time of publication, errors and omissions excepted.

CALCULATING SIZE AND PRICE

Drive Through & Total Sizing:

- Drive through width = Over guide width minus (guide width x 2)
- Drive through height = Guide height minus hangdown
- Total/overall height = Guide height plus headroom

	Width Priced on over guide width				Height Priced on guide height		
	Guides				Hangdown	Headroom	
	Up to 3000	Up to 4600	Up to 5200	Up to 5590		Up to 2500	Up to 3500
Excel	90	90	90		110	300	350
Original	75	75	90	90	110	300	350
LT	75	75	90		110	300	
Compact	60				50	205	
Manual	75				105	300	

Minimum and maximum sizes across the range:

	Over guide width (mm)		Guide Height (mm)	
	Min	Max	Min	Max
Excel	1500	5200	1500	3500
Original	1050	5590	1500	3700
LT	1050	5200	1500	2650
Compact	1050	3000	1700	2150
Manual	1000*	3000	1500	2300

*Minimum width above 2150 mm guide height = 1100 mm

