

UP & OVER
NEW CHASSIS
SPECIFICATION

GARAGE DOOR

PRICE LIST DECEMBER 2014

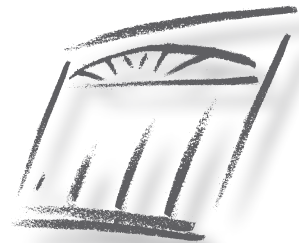

wessex
DOORS



NEW CHASSIS SPECIFICATION! Up and over doors are built onto a strong, corrosion protected steel chassis that provides a protective "picture frame" edge all around the door panel. The chassis is supplied in white, brown or black dependent on door colour and frames are available to match).



GRP GARAGE DOORS

Wessex GRP Products is Europe's largest manufacturer of low maintenance G.R.P. (Glass Reinforced Polyester) garage doors and a leading innovator in the field of garage door design.

Based in Verwood, Dorset, with its head office at Blackrod, Bolton, Wessex GRP Products manufactures a range of hand built and finished doors in strong durable G.R.P. with either luxury Gloss White or faithfully reproduced Woodgrain finishes..

Welcome to the Wessex Garage Doors Price List

G.R.P. is an incredibly strong, dent resistant modern composite laminate with a better strength to weight ratio than steel. The door face is devoid of joints, seams, rivets or fastenings to detract from its good looks. All doors are supplied fully finished, won't warp, shrink or rust and are virtually maintenance free. Up and over Doors are built onto a strong, corrosion protected steel chassis that provides a protective "picture frame" edge all around the door panel.









Contents:

G.R.P. SECTIONAL Garage Doors	3
G.R.P. UP AND OVER GARAGE DOORS	4 - 6
UP & OVER DOOR OPTIONS	7
AUTOMATION	7
G.R.P. SIDE HINGED GARAGE DOORS	8 - 9
TECHNICAL DETAILS	10 - 15
Warranty	16

PRICES & NOTES

All Prices are in £ Sterling and exclude VAT & delivery
Illustrations in this brochure are intended as a guide only to product styles and profiles. Handle positions will vary dependent upon the style, operation and size of the door. Side and top stiles (the area around a particular design) may vary in width and height dependent upon the size, even on doors of the same style.

Key to symbols

Standard Sizes only	
Made to Measure available	
Security Multi-Point Locking	
Glazing Options available – see page 7 for pricing	
Frames available – see page 9 for pricing	
Doors available over 2134mm (7'0") high	

DELIVERY CHARGES

All doors
Delivery charges any quantity of door: **£55.00 NET**
Mainland England, Scotland and Wales only. Northern Ireland, Channel Islands, Isle of Man, and export delivery – charges on application. Delivery charges and VAT to be added to all prices.



WIDTH	VIENNA		VIENNA DC		VIENNA 40		VIENNA 40 DC	
	Height 6'6" - 7'0" 1981 - 2134(mm)	Height >7'0" to 7'6" 2134 to 2286(mm)	Height 6'6" - 7'0" 1981 - 2134(mm)	Height >7'0" to 7'6" 2134 to 2286(mm)	Height 6'6" - 7'0" 1981 - 2134(mm)	Height >7'0" to 7'6" 2134 to 2286(mm)	Height 6'6" - 7'0" 1981 - 2134(mm)	Height >7'0" to 7'6" 2134 to 2286(mm)
2134mm (7'0")	1980	2145	2308	2473	2433	2598	2761	2927
2438mm (8'0")	2028	2196	2357	2525	2491	2661	2820	2989
2743mm (9'0")	2092	2253	2421	2581	2533	2695	2862	3023
3048mm (10'0")	2413	2574	2742	2902	3298	3459	3627	3787
3353mm (11'0")	2574	2735	2978	3140	3459	3620	3863	4025
3658mm (12'0")	2735	2896	3140	3300	3620	3781	4025	4185
3962mm (13'0")	2896	3056	3300	3461	3781	3942	4185	4347
4267mm (14'0")	2710	2868	3114	3273	3586	3743	3991	4148
4572mm (15'0")	3217	3377	3621	3782	4102	4263	4506	4668
4877mm (16'0")	3377	3538	3782	3942	4263	4422	4668	4826

MtoM widths: 6'10" to 16'0" MtoM heights: 6'6" to 7'6"
MtoM widths (mm): 2083 to 4877 MtoM heights (mm): 1981 to 2286

WIDTH	VIENNA • OSLO* VERONA		VIENNA • OSLO* VERONA DC		VIENNA • OSLO* VERONA 40		VIENNA • OSLO* VERONA 40 DC	
	Height 6'6" - 7'0" 1981 - 2134(mm)	Height >7'0" to 7'6" 2134 to 2286(mm)	Height 6'6" - 7'0" 1981 - 2134(mm)	Height >7'0" to 7'6" 2134 to 2286(mm)	Height 6'6" - 7'0" 1981 - 2134(mm)	Height >7'0" to 7'6" 2134 to 2286(mm)	Height 6'6" - 7'0" 1981 - 2134(mm)	Height >7'0" to 7'6" 2134 to 2286(mm)
2134mm (7'0")	2145	2310	2473	2638	2598	2761	2927	3090
2438mm (8'0")	2196	2366	2525	2695	2661	2830	2989	3158
2743mm (9'0")	2253	2413	2581	2742	2695	2854	3023	3183
3048mm (10'0")	2574	2735	2902	3064	3459	3620	3787	3949
3353mm (11'0")	2735	2896	3140	3300	3620	3781	4025	4185
3658mm (12'0")	2896	3056	3300	3461	3781	3942	4185	4347
3962mm (13'0")	3056	3217	3461	3621	3942	4102	4347	4506
4267mm (14'0")	2877	3035	3281	3439	3754	3910	4159	4315
4572mm (15'0")	3377	3538	3782	3942	4263	4422	4668	4826
4877mm (16'0")	3538	3701	3942	4105	4422	4583	4826	4988

*Oslo only available up to 2438mm (8'0") wide
MtoM widths: 6'10" to 16'0" MtoM heights: 6'6" to 7'6"
MtoM widths (mm): 2083 to 4877 MtoM heights (mm): 1981 to 2286



OPTIONS	
Manual locking	48
Black windows for Vienna single doors up to 2438mm (8'0") wide (please specify leading requirements)	160
Black windows for Vienna double doors over 2438mm (8'0") wide (please specify leading requirements)	320
Porthole Windows (Per window) Oslo only (please specify location) (330mm overall diameter, 250mm glazed diameter)	320
Colour Option available for Woodgrain doors only - blue, green and red - for single doors up to 2438mm (8'0") wide	300
Colour Option available for Woodgrain doors only - blue, green and red - for double doors over 2438mm (8'0") wide	395

DC OPTIONS	
Upgrade to Comfort 270 from Comfort 260 (for single sectionals up to 3048mm (10'))	68
Beam break	70
Beam break bracket	14
Wireless bell push	40
Wired bell push	12
Electric key switch control	41
Exterior digital keyless entry pad	93
Emergency release (handle type)	31
External receiver	102
Car cigarette lighter transmitter (3 channel)	58
Mini transmitter (4 channel)	49
Three function wired wall control	37
Impulse socket receiver	72
Chain Drive (standard)	0
Kevlar Belt drive	48
Two piece extended chain drive boom	21
Two piece extended Kevlar belt drive boom	74

UP & OVER
NEW CHASSIS
SPECIFICATION

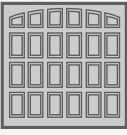
ONE PIECE UP & OVER GARAGE DOORS







M-M   7+

WIDTH	ASHTON			
	CANOPY		RETRACTABLE	
	3	4	3	4
1981mm (6'6")	1362	1482	1409	1529
2134mm (7'0")	1362	1482	1409	1529
2261mm (7'5")	1568	1688	1615	1735
2286mm (7'6")	1568	1688	1615	1735
2438mm (8'0")	1619	1739	1666	1786
2743mm (9'0")			1918	2118
3048mm (10'0")				
3353mm (11'0")				
3658mm (12'0")				
3962mm (13'0")				
4267mm (14'0")				
4572mm (15'0")				
4877mm (16'0")				

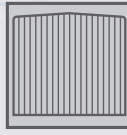
MtoM widths: 6'10³/₄" to 8'6"
MtoM heights: 6'7³/₄" to 7'6"

MtoM widths (mm): 2102 to 2591
MtoM heights (mm): 2025 to 2286





M-M   7+

WIDTH	AVONBROOK			
	CANOPY		RETRACTABLE	
	3	4	3	4
1981mm (6'6")	1362	1482	1409	1529
2134mm (7'0")	1362	1482	1409	1529
2261mm (7'5")	1568	1688	1615	1735
2286mm (7'6")	1568	1688	1615	1735
2438mm (8'0")	1619	1739	1666	1786
2743mm (9'0")			1918	2118
3048mm (10'0")			2086	2286
3353mm (11'0")			*2287	*2487
3658mm (12'0")			*2556	*2756
3962mm (13'0")			2644	2844
4267mm (14'0")			2670	2870
4572mm (15'0")			3056	3256
4877mm (16'0")			*3360	*3560

MtoM widths: 6'7³/₄" to *10'5"
& *11'5³/₄" to *15'6"
MtoM heights: 6'6" to 7'0"

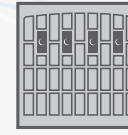
MtoM widths (mm): 2025 to *3175
& *3498 to *4724
MtoM heights (mm): 1981 to 2134





M-M   7+

WIDTH	BLENHEIM			
	CANOPY		RETRACTABLE	
	3	4	3	4
1981mm (6'6")				
2134mm (7'0")	2033	2153	2081	2201
2261mm (7'5")	2329	2449	2376	2496
2286mm (7'6")	2329	2449	2376	2496
2438mm (8'0")	2382	2502	2429	2549
2743mm (9'0")			2620	2820
3048mm (10'0")			2861	3061
3353mm (11'0")			2999	3199
3658mm (12'0")				
3962mm (13'0")				
4267mm (14'0")			*3487	*3687
4572mm (15'0")			3839	4039
4877mm (16'0")				

MtoM widths: 6'8³/₄" to 11'0"
& *13³/₄" to 15'0"
MtoM heights: 6'7³/₄" to 8'0"

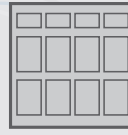
MtoM widths (mm): 2051 to 3353
& *4058 to 4572
MtoM heights (mm): 2025 to 2438





M-M   7+

WIDTH	CANTERBURY (WIDE GRAIN)			
	CANOPY		RETRACTABLE	
	3	4	3	4
1981mm (6'6")	1362	1482	1409	1529
2134mm (7'0")	1362	1482	1409	1529
2261mm (7'5")	1568	1688	1615	1735
2286mm (7'6")	1568	1688	1615	1735
2438mm (8'0")	1619	1739	1666	1786
2743mm (9'0")			1918	2118
3048mm (10'0")			2086	2286
3353mm (11'0")			2287	2487
3658mm (12'0")			2556	2756
3962mm (13'0")			2644	2844
4267mm (14'0")			2670	2870
4572mm (15'0")			3056	3256
4877mm (16'0")			3360	3560

MtoM widths: 6'0" to 16'0"
MtoM heights: 6'4" to 7'0"

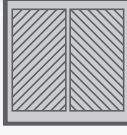
MtoM widths (mm): 1930 to 4877
MtoM heights (mm): 1930 to 2134

M-M   7+

WIDTH	COUNTY			
	CANOPY		RETRACTABLE	
	3	4	3	4
1981mm (6'6")				
2134mm (7'0")	1362	1482	1409	1529
2261mm (7'5")	1568	1688	1615	1735
2286mm (7'6")	1568	1688	1615	1735
2438mm (8'0")	1619	1739	1666	1786
2743mm (9'0")				
3048mm (10'0")				
3353mm (11'0")				
3658mm (12'0")			2556	2756
3962mm (13'0")			2644	2844
4267mm (14'0")			2670	2870
4572mm (15'0")			3056	3256
4877mm (16'0")			*3360	*3560

MtoM widths: 7'0" to 8'0"
& *12'4³/₄" to 15'4"
MtoM heights: 6'4³/₄" to 7'0"

MtoM widths (mm): 2134 to 2438
& *3778 to 4673
MtoM heights (mm): 2103 to 2134





M-M   7+

WIDTH	ELSTEAD			
	CANOPY		RETRACTABLE	
	3	4	3	4
1981mm (6'6")	1362	1482	1409	1529
2134mm (7'0")	1362	1482	1409	1529
2261mm (7'5")	1568	1688	1615	1735
2286mm (7'6")	1568	1688	1615	1735
2438mm (8'0")	1619	1739	1666	1786
2743mm (9'0")			*1918	*2118
3048mm (10'0")				
3353mm (11'0")				
3658mm (12'0")				
3962mm (13'0")				
4267mm (14'0")			*2618	*2818
4572mm (15'0")			3056	3256
4877mm (16'0")				

MtoM widths: 6'11³/₄" to 8'5"
& *13'2³/₄" to *15'0"
MtoM heights: 6'5³/₄" to 7'6"

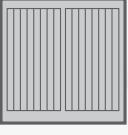
MtoM widths (mm): 2128 to *2565
& *4032 to *4572
MtoM heights (mm): 1975 to 2286



M-M   7+



WIDTH	FRENSHAM (WIDE GRAIN)			
	CANOPY		RETRACTABLE	
	3	4	3	4
1981mm (6'6")	1362	1482	1409	1529
2134mm (7'0")	1362	1482	1409	1529
2261mm (7'5")	1568	1688	1615	1735
2286mm (7'6")	1568	1688	1615	1735
2438mm (8'0")	1619	1739	1666	1786
2743mm (9'0")				
3048mm (10'0")				
3353mm (11'0")				
3658mm (12'0")				
3962mm (13'0")				
4267mm (14'0")			*2618	*2818
4572mm (15'0")			3056	3256
4877mm (16'0")			*3360	*3560

Note 7'6"-8'0" (2286mm - 2438mm) wide Frensham doors have extra wide end stiles - please ask for details before ordering. The feature height of single doors up to 6'6" (1981mm) high, over 6'7" (2007mm) high and the double doors all vary, please check for doors to be fitted side by side.

MtoM widths: 6'9³/₄" to 8'0" & *13'11" to *15'1"
MtoM heights: 6'4" to 6'7" & 6'8³/₄" to 7'0"

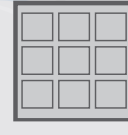
MtoM widths (mm): 2076 to 2438 & *4242 to *4597
MtoM heights (mm): 1931 to 2006 and 2050 to 2134



S-S   7+

WIDTH	MAJESTIC			
	CANOPY		RETRACTABLE	
	3	4	3	4
1981mm (6'6")	1336	1456	1383	1503
2134mm (7'0")	1336	1456	1383	1503
2261mm (7'5")	1373	1493	1420	1540
2286mm (7'6")	1373	1493	1420	1540
2438mm (8'0")	1424	1544	1471	1591
2743mm (9'0")				
3048mm (10'0")				
3353mm (11'0")				
3658mm (12'0")				
3962mm (13'0")				
4267mm (14'0")				
4572mm (15'0")				
4877mm (16'0")				

SS widths: 7'0", 7'5", 7'6", 8'0"
SS heights: 6'6" or 7'0"

SS widths (mm): 2134, 2261, 2286, 2438
SS heights (mm): 1981 or 2134

ONE PIECE UP & OVER GARAGE DOORS

6

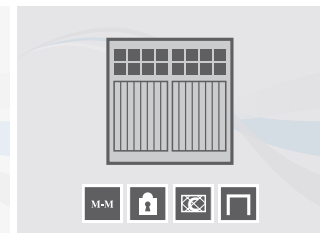
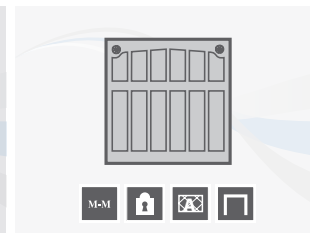
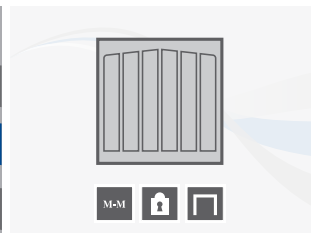

WIDTH	PEMBROKE (WIDE GRAIN)			
	CANOPY		RETRACTABLE	
	3	4	3	4
1981mm (6'6")				
2134mm (7'0")	1362	1482	1409	1529
2261mm (7'5")	1568	1688	1615	1735
2286mm (7'6")	1568	1688	1615	1735
2438mm (8'0")	1619	1739	1666	1786
2743mm (9'0")			1918	2118
3048mm (10'0")			2086	2286
3353mm (11'0")			2287	2487
3658mm (12'0")			2556	2756
3962mm (13'0")			2644	2844
4267mm (14'0")			2670	2870
4572mm (15'0")			3056	3256
4877mm (16'0")			*3360	*3560

WIDTH	PURBECK			
	CANOPY		RETRACTABLE	
	3	4	3	4
1981mm (6'6")				
2134mm (7'0")	1607	1727	1654	1774
2261mm (7'5")	1655	1775	1702	1822
2286mm (7'6")	1655	1775	1702	1822
2438mm (8'0")	1705	1825	1752	1872
2743mm (9'0")			*1844	*2044
3048mm (10'0")				
3353mm (11'0")				
3658mm (12'0")				
3962mm (13'0")				
4267mm (14'0")			*2704	*2904
4572mm (15'0")			3036	3236
4877mm (16'0")				

WIDTH	SHERBOURNE			
	CANOPY		RETRACTABLE	
	3	4	3	4
1981mm (6'6")				
2134mm (7'0")	1362	1482	1409	1529
2261mm (7'5")	1568	1688	1615	1735
2286mm (7'6")	1568	1688	1615	1735
2438mm (8'0")	1619	1739	1666	1786
2743mm (9'0")			1918	2118
3048mm (10'0")			*2086	*2286
3353mm (11'0")				
3658mm (12'0")			*2556	*2756
3962mm (13'0")			2644	2844
4267mm (14'0")			2618	2818
4572mm (15'0")			3056	3256
4877mm (16'0")				

WIDTH	SHERWOOD (WIDE GRAIN)			
	CANOPY		RETRACTABLE	
	3	4	3	4
1981mm (6'6")				
2134mm (7'0")	1607	1727	1654	1774
2261mm (7'5")	*1655	*1775	*1702	*1822
2286mm (7'6")	1655	1775	1702	1822
2438mm (8'0")	1705	1825	1752	1872
2743mm (9'0")			*1844	*1964
3048mm (10'0")				
3353mm (11'0")				
3658mm (12'0")				
3962mm (13'0")				
4267mm (14'0")			2704	2904
4572mm (15'0")			3036	3236
4877mm (16'0")			3334	3534

MtoM widths: 6'11³/₄" to *15'7"
MtoM heights: 6'4³/₄" to 7'0"

MtoM widths: 6'11³/₄" to *8'5"
& *13'7³/₄" to 15'1"
MtoM heights: 6'4" to 7'0"

MtoM widths: 6'9¹/₂" to 9'5"
& *11'4¹/₄" to 13'1" & 13'6¹/₄" to 15'1"
MtoM heights: 6'7³/₄" to 7'1"

MtoM widths: *7'0" & *7'3³/₄" to *8'6"
& *14'0" to 16'0"
MtoM heights: 6'5³/₄" to 7'0"

MtoM widths (mm): 2128 to *4749
MtoM heights (mm): 1949 to 2134

MtoM widths: 2128 to *2565
& *4159 to 4597
MtoM heights: 1931 to 2134

MtoM widths (mm): 2056 to 2870
& *3473 to 3987 & *4121 to 4587
MtoM heights (mm): 1931 to 2159

MtoM widths (mm): *2134 & *2229 to
*2590 & *4267 to 4877
MtoM heights (mm): 1975 to 2134

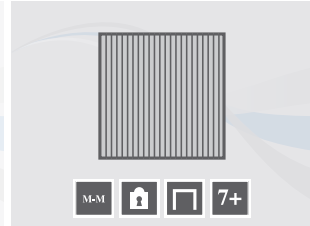
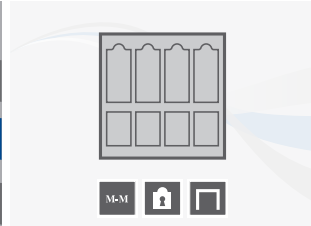

WIDTH	WARWICK			
	CANOPY		RETRACTABLE	
	3	4	3	4
1981mm (6'6")	1362	1482	1409	1529
2134mm (7'0")	1362	1482	1409	1529
2261mm (7'5")	1568	1688	1615	1735
2286mm (7'6")	1568	1688	1615	1735
2438mm (8'0")	1619	1739	1666	1786
2743mm (9'0")			1918	2118
3048mm (10'0")			2086	2286
3353mm (11'0")			2287	2487
3658mm (12'0")			2556	2756
3962mm (13'0")			2644	2844
4267mm (14'0")			2670	2870
4572mm (15'0")			3056	3256
4877mm (16'0")			3360	3560

WIDTH	YORK			
	CANOPY		RETRACTABLE	
	3	4	3	4
1981mm (6'6")	1362	1482	1409	1529
2134mm (7'0")	1362	1482	1409	1529
2261mm (7'5")	1568	1688	1615	1735
2286mm (7'6")	1568	1688	1615	1735
2438mm (8'0")	1619	1739	1666	1786
2743mm (9'0")			1918	2118
3048mm (10'0")			2086	2286
3353mm (11'0")			2287	2487
3658mm (12'0")			2556	2756
3962mm (13'0")			2644	2844
4267mm (14'0")			2670	2870
4572mm (15'0")			3056	3256
4877mm (16'0")			3360	3560

MtoM widths: 7'0" to 16'0"
MtoM heights: 6'7³/₄" to 7'0"

MtoM widths (mm): 2134 to 4877
MtoM heights (mm): 2025 to 2134

MtoM widths: 6'0" to 16'0"
**MtoM heights: 6'4" to 8'0"

MtoM widths (mm): 1830 to 4877
**MtoM heights (mm): 1931 to 2438



WINDOWS*, LOCKS, COLOURS, DRAUGHT STRIPS AND BRACKETS

Black windows on single doors up to 2438mm (8'0") wide (please specify leading requirements)		160 per door
Black windows on double doors over 2438mm (8'0") wide (please specify leading requirements)		320 per door
Clear or Stippled windows on single doors up to 2438mm (8'0") (please specify leading requirements)		328 per door
Clear or Stippled windows on double doors over 2438mm (8'0") (please specify leading requirements)		655 per door
Clear or Stippled windows on single doors up to 2438mm (8'0") (please specify leading requirements)		360 per door
Clear or Stippled windows on double doors over 2438mm (8'0") (please specify leading requirements)		720 per door
Clear or Stippled windows on single doors up to 2438mm (8'0") (please specify leading requirements)		430 per door
Clear or Stippled windows on double doors over 2438mm (8'0") (please specify leading requirements)		860 per door
Colour Option available for Woodgrain doors only – blue, green and red for single doors up to 2438mm (8'0") wide		300 per door
Colour Option available for Woodgrain doors only – blue, green and red for double doors over 2438mm (8'0") wide		395 per door
Coastal colour options available for Woodgrain doors only –		
Beaumont Blue, Bluebell Blue, Seagrass Green, County Cream and Charleston Grey for single doors up to 2438mm (8'0") wide		300 per door
Beaumont Blue, Bluebell Blue, Seagrass Green, County Cream and Charleston Grey for single doors over 2438mm (8'0") wide		395 per door
Brass effect finish lock (upgrade from black lock)		45 per set
Adjustable deep reveal brackets (for use with retractable gear only) Size 1	0 - 152mm (0" - 6")	58 per pair
	Size 2 152 - 305mm (6" - 12")	63 per pair
	Size 3 305 - 457mm (12" - 18")	65 per pair
	Size 4 457 - 610mm (18" - 24")	67 per pair
Draught Strip (bottom edge brush strip helps prevent dirt and draughts blowing into your garage) single/double doors		42 / 81

*Please note: Diagonal bracings will be visible on double doors

FRAMES

Steel Frames

Canopy Doors

Suitable for all single doors up to 2438mm x 2134mm (8'0" x 7'0"). Frames are pre-fitted to the door. Standard frame jambs are 60mm wide and the frame head is 60mm high. Minimum door height 1930mm (6'4").

Single Retractable Doors

Suitable for all single doors up to . Frames are pre-fitted to the door. Jambs are 75mm wide and the head is 60mm (2.2/3") high. Minimum door height 1930mm (6'4").

Double Retractable Doors

Suitable for all doors over 3048mm x 2134mm (10'0" x 7'0") and up to 4877mm x 2438mm (16'0" x 8'0"). Frames are supplied as a kit for on-site assembly to the door. Jambs are 75mm wide and the head is 60mm (2.2/3") high. Minimum door height 1930mm (6'4").

UPVC Timber Cored Frame Sections

Supplied in three sections with mitred corners, these frames are 70mm x 70mm (2.3/4" x 2.3/4") for doors up to 4877mm x 2438mm (16'0" wide x 8'0" high). Frames include a fixing groove and cover strip for concealed fixing. Frames are available in White or Woodgrain laminate finish in Rosewood and Golden Oak (closely matches G.R.P. Dark Mahogany and Honey Beech colour finishes). Frame sections are not pre-fitted and are supplied loose for fitment to any door.

UPVC Timber Cored Uprights Only (per pair)

Uprights are available in 70mm x 70mm (2.3/4" x 2.3/4") for doors up to 2438mm (8'0") high. Uprights are available in finishes as uPVC frame sections above. Uprights are not pre-fitted and are supplied loose for fitment to any door.

G.R.P. Frame Sections

Supplied in three sections, these frames are in two sizes 70mm x 70mm or 95mm x 70mm (2.3/4" x 2.3/4" or 3.3/4" x 2.3/4") for doors up to 4877mm x 2438mm (16'0" wide x 8'0" high). Frames are available in Gloss White or Woodgrain finish in standard colours. Frame sections are not pre-fitted and are supplied loose for fitment to any door.

Steel Frames (Standard Sizes or Made to Measure)		Low maintenance white, brown or black			
60mm to suit Canopy doors gear pre-fitted to doors		127			
75mm to suit single Retractable doors with gear pre-fitted to doors		144			
75mm to suit double Retractable doors Supplied as a kit for on-site assembly		348			
UPVC Timber Cored Frames c/w fixing groove & cover strip		White	Textured Grained Black, Woodgrain Rosewood or Golden Oak (closely matches G.R.P. Dark Mahogany & Honey Beech)		
Width	Height				
Up to 8ft (2438mm)	Up to 8ft (2438mm)	151	199		
Up to 11ft (3353mm)	Up to 8ft (2438mm)	190	237		
Up to 16ft (4877mm)	Up to 8ft (2438mm)	237	308		
Jambs only	Up to 8ft (2438mm)	131	172		
G.R.P. Frames (3 section)		Up to 2134mm (7'0")	2134mm (7'0") - 3353mm (11'0")	3353mm (11'0") - 4572mm (15'0")	4572mm (15'0") - 4877mm (16'0")
Gloss White 70mm x 70mm		363	426	485	568
Gloss White 95mm x 70mm		409	501	551	634
Woodgrain 70mm x 70mm		392	457	521	605
Woodgrain 95mm x 70mm		448	520	592	683









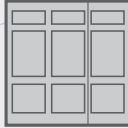

ELECTRIC OPERATORS

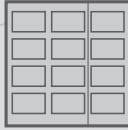
Electric Operators & Boom Options	
Comfort 260 (For retractable doors)	370
Comfort 270 (For retractable doors)	450
Kevlar belt drive	48
Chain drive	0
Medium extended toothed belt / chain drive boom	21
Medium extended toothed Kevlar belt drive boom	74
Long extended chain drive boom (DC-850)	53
Long extended Kevlar belt drive boom (DC-850)	95

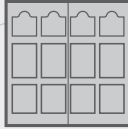
Operator Accessories DC-700/850	
Beam break	70
Beam Break Bracket	15
Wireless bell push	40
Wired bell push	12
Electric key switch control	41
Exterior digital keyless entry pad	93
Emergency release (handle type)	31
External receiver	102
Car cigarette lighter transmitter (3 channel)	58
Mini transmitter (4 channel)	49
Three function wired wall control	37
Impulse socket receiver	72

SIDE HINGED GARAGE DOORS

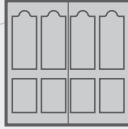
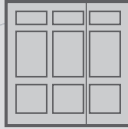
8

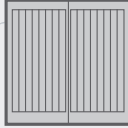
STYLE	CLASSIC	PREMIER	DOOR LEAF	SIZE & WINDOW AVAILABILITY
 CHELTENHAM GLOSS WHITE	1201	1525	2/3 : 1/3	Widths 2007mm - 2438mm (6'7" - 8'0") Heights 1880mm - 2134mm (6'2" - 7'0") M-M 
 EDWARDIAN GLOSS WHITE	1201	1525	2/3 : 1/3	Widths 2007mm - 2438mm (6'7" - 8'0") Heights 1880mm - 2134mm (6'2" - 7'0") M-M 
 EMSWORTH- GLOSS WHITE	1201	1525	50 : 50	Widths 2007mm - 2438mm (6'7" - 8'0") Heights 1905mm - 2286mm (6'3" - 7'6") M-M  7+
 GRAFTON GLOSS WHITE	1201	1585	50 : 50	Widths 2083mm - 2438mm (6'10" - 8'0") Heights 1905mm - 2286mm (6'3" - 7'6") M-M  7+
 NEWBURY GLOSS WHITE	1201	1525	50 : 50	Widths 1981mm - 2438mm (6'6" - 8'0") Heights 1880mm - 2134mm (6'2" - 7'0") M-M
 BOSTON WOODGRAIN	1299	1585	2/3 : 1/3	Widths 1778mm - 2286mm (5'10" - 7'6") Heights 2134mm - 2438mm (7'0" - 8'0") M-M  7+
 FRENSHAM WOODGRAIN	1299	1585	50 : 50	Widths 2007mm - 2438mm (6'7" - 8'0") Heights 1727mm - 2134mm (5'8" - 7'0") M-M

Key:  Made to measure  Windows available  Heights over 2134mm available



OPTIONS

Locking	£
Eurolock multi-point latch upgrade to standard Classic range night latch	150
Brass effect hinge upgrade to Classic range	43
Left hand opening / Inward opening - only available on doors with Euro-style locking and supplied without stays	59 / 102
WINDOWS	£
*Black windows - Cheltenham, Boston, Edwardian, Emsworth, Grafton, Majestic, Rushmoor, Sherborne	160
*Clear or stippled windows - Cheltenham, Boston, Edwardian, Emsworth, Grafton, Majestic, Rushmoor, Sherborne / Sherwood	328 / 430
*Available with border, diamond or square leading - please state when ordering	
Frames	£
50mm white, black or brown frame (50mm frame legs, 38mm head)	Standard
Unframed (deletion cost)	-43
Colours	£
Red / green / blue solid woodgrain colour option	300
Coastal colour options available for Woodgrain doors: Beaumont Blue, Bluebell Blue, Seagrass Green, County Cream and Charleston Grey	300

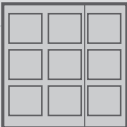

All prices exclude VAT and delivery

SIDE HINGED GARAGE DOORS

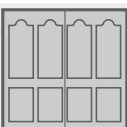
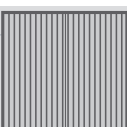
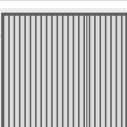
STYLE	CLASSIC	PREMIER	DOOR LEAF	SIZE & WINDOW AVAILABILITY
 <p>LOXWOOD WOODGRAIN</p>	1299	1643	50 : 50	Widths 2083mm - 2438mm (6'10" - 8'0") Heights 1905mm - 2286mm (6'3" - 7'6") M-M 7+
 <p>MAJESTIC WOODGRAIN</p>	1231	1585	2/3 : 1/3	Widths 1981mm - 2438mm (6'6" - 8'0") Heights 1854mm - 2134mm (6'1" - 7'0") M-M ☒
 <p>RUSHMOOR WOODGRAIN</p>	1390	1643	50 : 50	Widths 2083mm - 2438mm (6'10" - 8'0") Heights 1905mm - 2286mm (6'3" - 7'6") M-M ☒ 7+
 <p>SHERWOOD WOODGRAIN</p>	1398	1702	50 : 50	Widths 2134mm - 2438mm (7'0"* - 8'0") Heights 1905mm - 2134mm (6'3" - 7'0") M-M ☒
 <p>WARWICK WOODGRAIN</p>	1390	1585	50 : 50	Widths 1981mm - 2438mm (6'6" - 8'0") Heights 1880mm - 2134mm (6'2" - 7'0") M-M
 <p>YORK WOODGRAIN</p>	1122	1585	50 : 50	Widths 1219mm - 2438mm (4'0" - 8'0") Heights 1778mm - 2286mm (5'10" - 7'6") M-M 7+
 <p>YORK WOODGRAIN</p>	1122	1585	2/3 : 1/3	Widths 1524mm - 2438mm (5'0" - 8'0") Heights 1778mm - 2286mm (5'10" - 7'6") M-M 7+

Key:  Made to measure  Windows available  Heights over 2134mm available

TECHNICAL & GENERAL INFORMATION

Classic

- 50mm frame (standard) 50mm uprights and a 38mm head
- 3/4 steel hinges per side (dependent on size)
- Silver effect nightlatch with white lock body, single point latching
- Bonded steel chassis for strength
- Pair of white polyester painted stays
- Two shoot bolts (inactive leaf)
- Draft strip to all 3 sides
- Bottom weather strip
- Outward opening, right hand leading leaf viewed from outside (Left hand leading or inward opening available - see options right)

Premier

- 50mm frame (standard) 50mm uprights and a 38mm head
- 3/4 brass effect dog bolt hinges per side (dependent on size)
- Brass Eurocylinder nightlatch with double throw deadbolt and multi-point latching
- The rear of the door is reinforced with a steel chassis that is covered with a "flowcoat" of resin for increased rigidity and a neat, light reflecting finish
- Pair of white painted stays
- Two shoot bolts (inactive leaf)
- Draft strip to 3 sides
- Bottom weather strip
- Outward opening, right hand leading leaf viewed from outside (Left hand leading or inward opening available - see options right)

General Information

- **Handle Positions**
These will vary between doors of different sizes of the same style.
- **Glazed G.R.P. Doors**
All window design doors are fitted with standard black (opaque) windows, which cannot be seen through. Clear and stippled translucent windows are available as options.
- **Matching Woodgrain G.R.P. Doors**
Where doors are to be fitted in close proximity and are required to be coloured as closely as possible, it is vital that they are clearly requested 'To Match' at time of ordering.
- **Made to Measure Door Prices**
There is no additional charge for made to measure sizes. Note: please refer to the size parameter details beside the price for the actual minimum / maximum door size available.
- **Opening Size**
All door sizes stated in this price list refer to internal frame dimensions. Due to the bespoke nature of Wessex garage doors we regret we can not accept order cancellations.
- **Top & Bottom Rails & End Stiles**
Top, bottom, centre and end stiles (edges) may vary in width or height between doors of the same style depending on size ordered. This is to enable us to cater for your particular size of garage door. If in doubt, please refer to Wessex before ordering.
- **Translucency**
Translucency of the door panel on Classic doors may vary when viewed from the inside on a bright day due to variations in laminate thickness. This does not represent a manufacturing defect and overall performance is not affected.

VIENNA, OSLO & VERONA

A double skinned fully finished and made to measure G.R.P. Sectional Garage door. The panels are made from triple layer resin 450 gram CSM glass mat reinforcement and 'matted in' steel stiffeners. The rear of the door is finished with a white flat back panel. Doors over 4420mm (14'6") have additional white powder coat bracings attached to the rear of the panels. Doors features full weather seals on both sides, at the head and where the door closes to the ground to reduce water and wind borne debris ingress. The interface of each panel has an anti finger-trap CEN compliant safety design (patent pending). Available in High Gloss White (Vienna only) and all standard Wessex Woodgrain colours including the three solid colour options.

VIENNA, OSLO & VERONA DC MODEL

The DC model has all the benefits of the standard door but is supplied with a state-of-the-art electric operator which is matched to the door. A DC700, with a 700N lifting force, is supplied for doors up to 3048mm (10'0") wide and the more powerful DC850, with 850N lifting force, is supplied for doors over this size. Both operators feature DC motors, soft start-soft stop and anti-back drive security system. This reacts to movement on the boom, if forced entry of a closed door is attempted, and automatically switches from stand-by mode to drive the door closed. A quiet chain drive one-piece boom is standard with a kevlar belt drive option available as a cost option for even smoother, quieter operation. Please note that an extended boom is recommended for doors over 2134mm (7'0") high.

VIENNA, OSLO & VERONA "40" MODEL

The "40" model has double skinned, foam filled, insulated panels for maximum insulation, sound proofing and strength. The rear of the door is finished with a white flat back panel. Doors over 4420mm (14'6") have additional white powder coat bracings attached to the rear of the panels. The "40" model also has all round weather seals and an anti finger-trap panel interface design (patent pending). Available in High Gloss White (Vienna only) and all standard Wessex Woodgrain colours including the three solid colour options.

VIENNA 40 DC

The "40" DC model has all the benefits of Standard "40" model but is supplied with a state-of-the-art electric operator which is matched to the door. A DC700, with a 700N lifting force, is supplied for doors up to 3048mm (10'0") wide and the more powerful DC850, with 850N lifting force, is supplied for doors over this size. Both operators feature DC motors, soft start-soft stop and anti-back drive security system. This reacts to movement on the boom, if forced entry of a closed door is attempted, and automatically switches from stand-by mode to drive the door closed. A quiet chain drive one-piece boom is standard with a kevlar belt drive option available as a cost option for even smoother, quieter operation. Please note that an extended boom is recommended for doors over 2134mm (7'0") high.

GEAR ING

Lifting gear is a CEN Compliant galvanised steel dual track system with standard low head room gear. It requires only 70mm side and headroom clearance and the top edge of the top panel does not rise above the horizontal track. If the 'Manual locking' option is selected, headroom requirement increases by 60mm and both DC variants require an additional 30mm headroom for the operator boom (50mm on doors over 4420mm / 14'6"). The spring assembly is not wider than the track which means easy installation to flush walls. There is no reduction of drive through width and drive through height is reduced by only 70mm on a manual door and 30mm on an automated door.

GENERAL INFORMATION

Locking

All door variants are supplied without locking. If ordered as a manually operated door, or locking is required, the 'Manual locking' option must be ordered. The door is prepared for the handle to fit in the first right hand vertical stile, viewed from outside, on the second panel up from the floor.

Window Options

Vienna, Vienna 40 and DC variants are available with black (opaque) windows, which cannot be seen through. Clear and stippled translucent windows are not available. The Oslo is available with porthole windows to one or all panels. Porthole windows are finished with stainless steel and have a double glazed toughened glass vision panel. Porthole window position is set to 400 mm from the left or right edge of the doors and are installed centrally in the panel profile. Other positions can be accommodated on request.

Matching Woodgrain Doors

Where doors are to be fitted in close proximity and are required to be coloured as closely as possible, it is vital that they are clearly requested 'To Match' at time of ordering.

Made to Measure Doors

For a made to measure price take the next door size up e.g. 3810mm (12'6") wide x 2032mm (6'8") high is taken from the 3962mm (13'0") wide x 2134mm (7'0") high price.

Opening Size

All door sizes in this price list refer to internal brickwork / internal frame dimensions. See note "How to order your Door"

How to Order Your Door

Sectional doors are designed to be fitted either on to the back face of a brickwork opening or on to the back face of a timber frame* fitted within the opening. Therefore when ordering your door you must either give us the internal brickwork opening size for doors being fitted directly to the back of the brickwork, or the internal timber frame* size for doors being fitted on to a timber frame*.

*Timber frame must be a minimum of 70mm x 70mm (23/4" x 23/4").

Top & Bottom Rails & End Stiles

Top, bottom and end stiles (edges) may vary in width or height between doors of the same style depending on size ordered. This is to enable us to cater for your particular size of garage door. If in doubt, please refer to Wessex before ordering.

Finishing & maintenance

G.R.P. Doors

Please study the cleaning and maintenance label attached to the back of the door for advice on keeping your door in top class condition.

Door Lubrication

All doors require regular (6 monthly) lubrication of the pivot points and bearings. Full details are contained in the Wessex Service Passport supplied with the door.

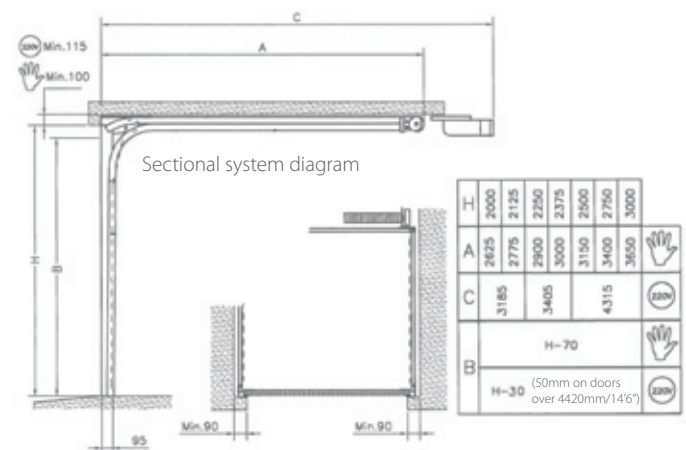

G.R.P. CROWN RANGE

• **3 Crown G.R.P. Doors (Standard)**

Garage doors in standard and made to measure sizes, featuring a corrosion protected steel chassis to provide added strength and rigidity. Available with canopy or retractable gear. Available with window options where applicable.

• **4 Crown G.R.P. Doors**

Garage doors in standard and made to measure sizes, featuring a corrosion protected steel chassis to provide added strength and rigidity. The back of the door panel is covered with a "flowcoat" of resin for increased rigidity and a neat interior finish in light reflecting white. Available with canopy or retractable gear. Available with window options where applicable.

• **Chassis Colour**

White doors will come on a white chassis, ebony woodgrain doors on black chassis and all other woodgrain colours on brown chassis. Red, Green and Blue colours and Coastal colours on a white or black chassis.

GEARING

• **Canopy Gear**

Canopy doors between 1930mm (6'4") and 2134mm (7'0") high and up to 2438mm (8'0") wide are fitted with Canopy gear featuring high security two point locking and five point retention.

• **Single Retractable Gear**

All retractable doors between 1930mm (6'4") and 2134mm (7'0") high and up to 3048mm (10'0") wide are supplied with cranked gear. This gear includes unique maximum opening width feature and multi springing. Two point locking is standard on most doors.

• **Double Retractable Gear**

All doors over 2134mm (7'0") high and all doors over 3048mm (10'0") wide are supplied with this gear. All have multi-springing feature.

LOCKING

All Wessex doors are supplied with secure two-point locking as standard. Optional brass effect lock available.

GENERAL INFORMATION

• **Handle Positions**

These will vary between canopy and retractable doors of the same size and same style, and between doors of different sizes of the same style with the same gear.

• **Handle Holes**

These will be drilled as standard. If a handle hole is not required this must be clearly stated at time of ordering.

• **Glazed G.R.P. Doors**

All window design doors are fitted with standard black (opaque) windows, which cannot be seen through. Clear and stippled translucent windows are available as options on 3 Crown doors only.

• **Matching Woodgrain G.R.P. Doors**

Where doors are to be fitted in close proximity and are required to be coloured as closely as possible, it is vital that they are clearly requested 'To Match' at time of ordering.

• **Made to Measure Door Prices**

Take the next door size up e.g. 3810mm (12'6") wide x 2032mm (6'8") high take the 3962mm (13'0") price. Note: Where a price is marked * please refer to the size parameter details below the price for the actual maximum / minimum door size available.

• **Opening Size**

All door sizes stated in this price list refer to internal frame dimensions. Due to the bespoke nature of Wessex garage doors we regret we can not accept order cancellations.

• **Top & Bottom Rails & End Stiles**

Top, bottom and end stiles (edges) may vary in width or height between doors of the same style depending on size ordered. This is to enable us to cater for your particular size of garage door. If in doubt, please refer to Wessex before ordering.

FINISHING & MAINTENANCE

• **G.R.P. Doors**

Please study the cleaning and maintenance label attached to the back of the door for advice on keeping your door in top class condition.

• **Steel Frames**

Primed steel frames require a suitable undercoat and topcoat to be applied shortly after delivery in order that the product warranty is not invalidated.

• **Door Lubrication**

All doors require regular (6 monthly) lubrication of the pivot points and bearings. Full details are contained in the Wessex Service Passport supplied with the door.

TECHNICAL & GENERAL INFORMATION

AUTOMATION

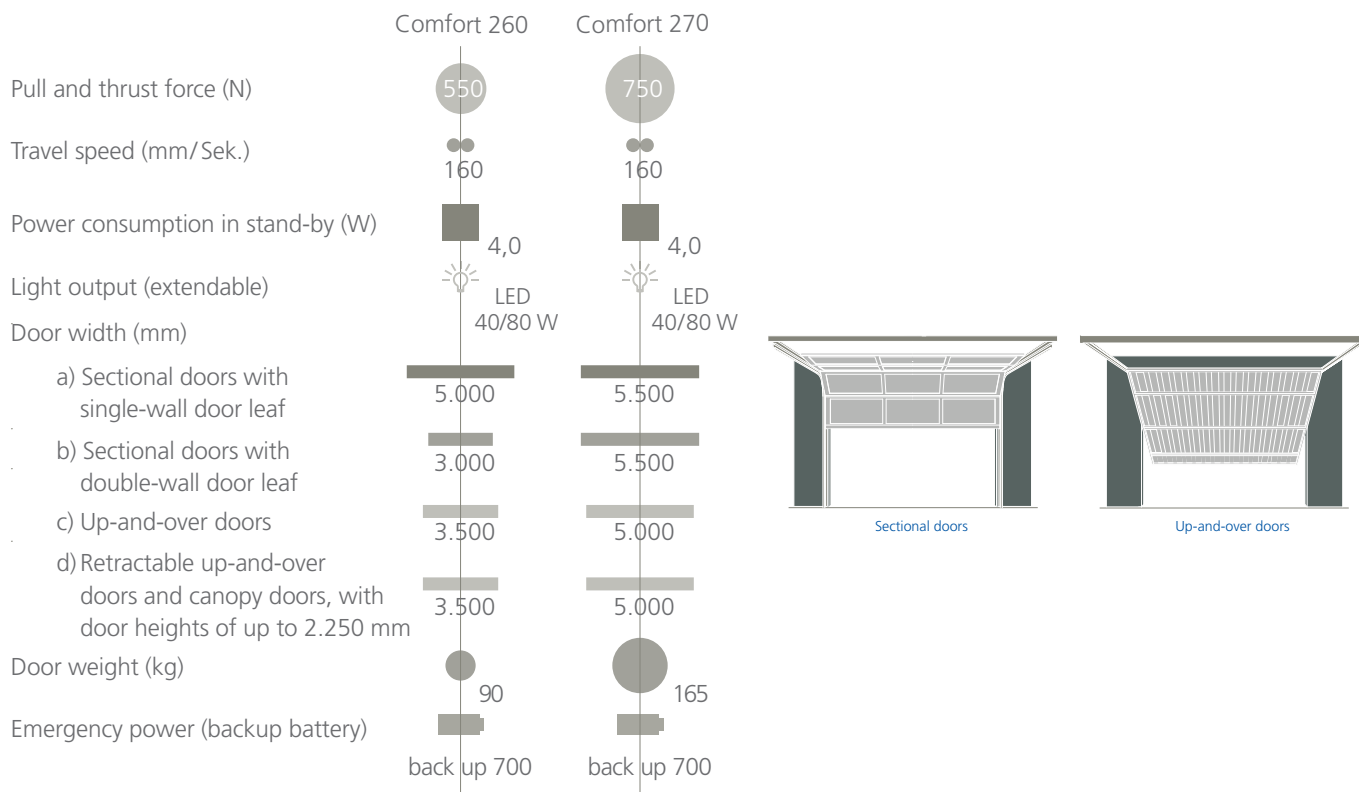

Canopy Gear Specifications

The canopy gear allows the door to travel in vertical tracks and is counterbalanced by an overhead torsion spring.

The nominal drive through is 40 mm less than the opening width and 130 mm less than the opening height.

In the open position, the door projects approximately one third of the door height, forming a canopy.

For doors fitted with an operator, please respect operator specifications.

12

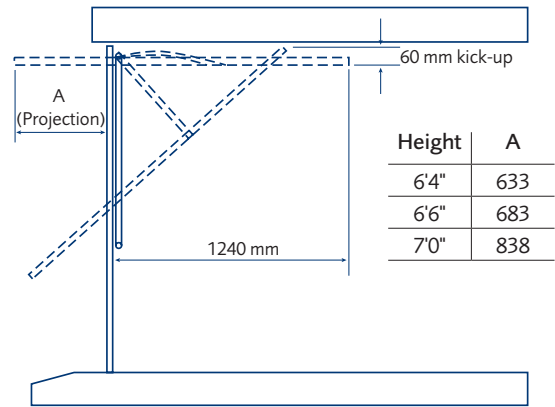

On-site timber frame

Behind brickwork fixing

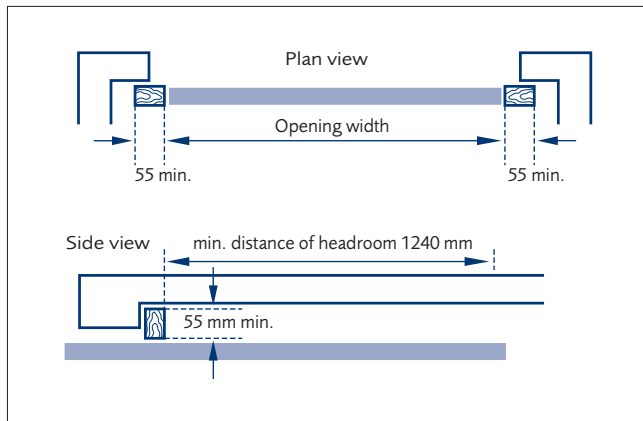

Between brickwork fixing

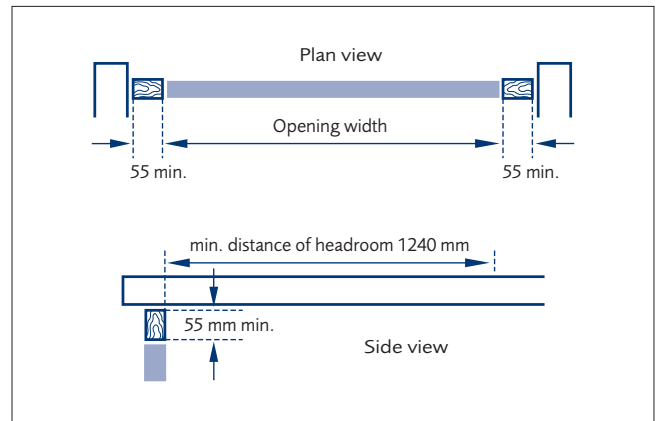

Factory pre-framed with steel box frame

The garage door is supplied factory fitted to a steel box section frame and is secured to the brickwork by using just 7 fixings.

Behind brickwork fixing

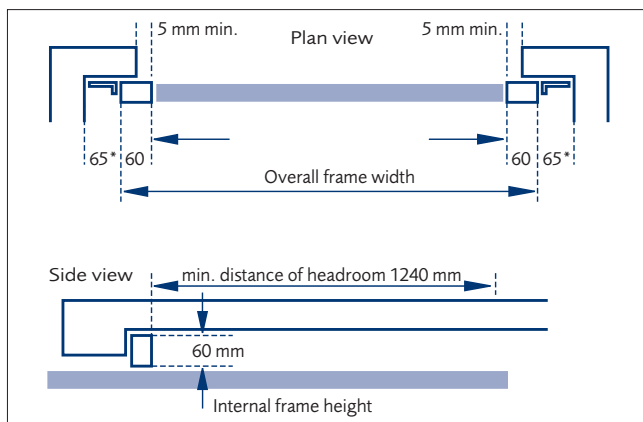

* width of anchor in this position

Between brickwork fixing

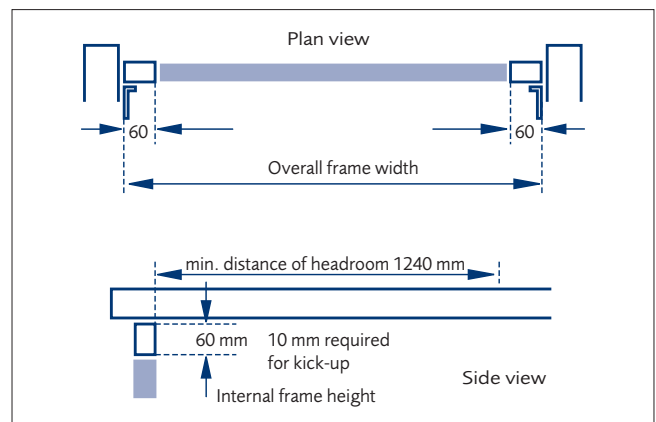

Single & Double Retractable Gear Specifications

The retractable gear allows the door to be retracted inside the garage when open by means of horizontal overhead tracks supported by wall or ceiling mounted suspension brackets. This gear is available as an option for single doors and comes as standard with double garage doors.

The nominal drive through clearance is 105 mm less than the opening width and 110 mm less than the opening height for single doors and 140 mm less than the opening height for double doors.

For doors fitted with an operator, please respect operator specifications.

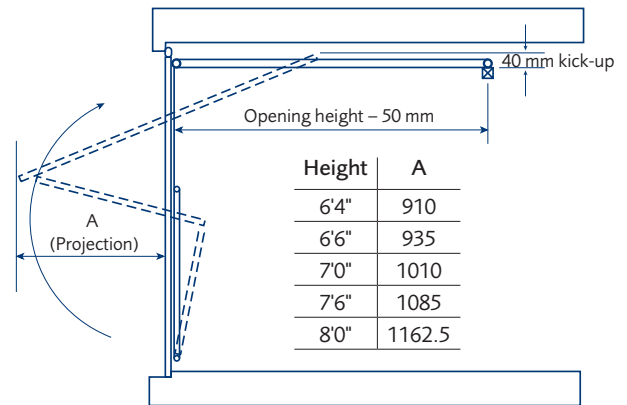

On-site timber frame

Behind brickwork fixing

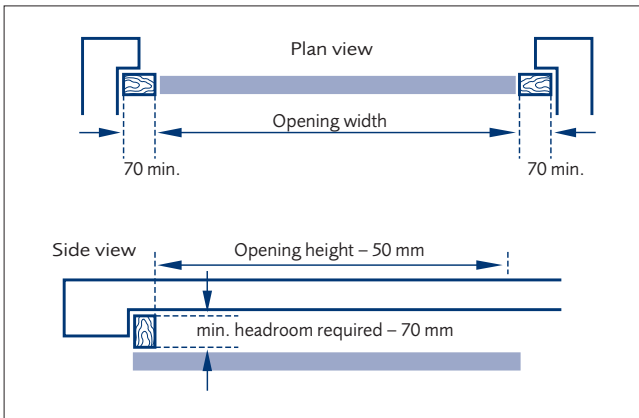

Between brickwork fixing

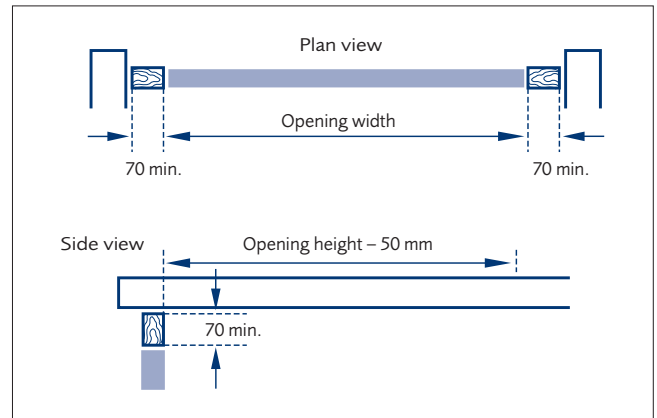

Factory pre-framed with steel box frame

The garage door is supplied factory fitted to a steel box section frame and is secured to the brickwork by using just 7 fixings.

Behind brickwork fixing

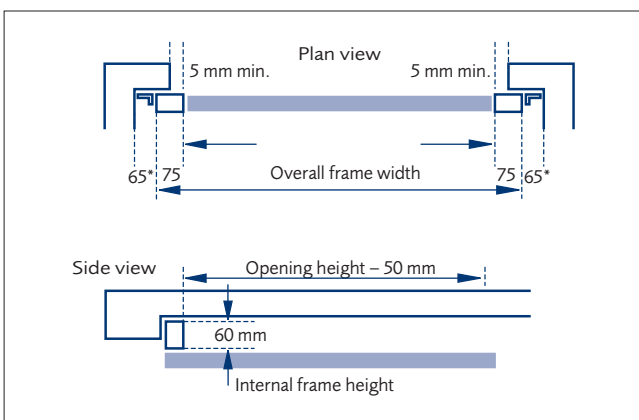

* width of anchor in this position

Between brickwork fixing

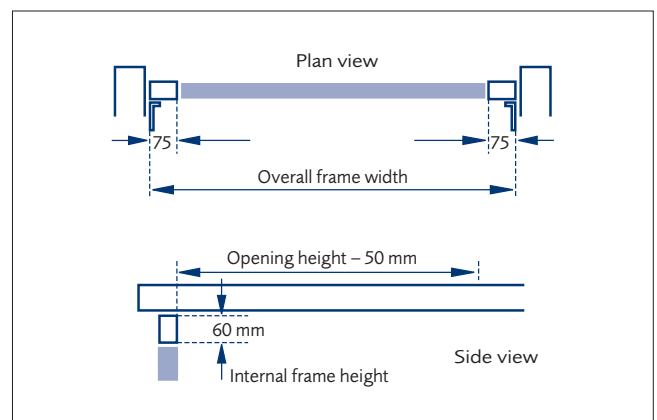

Frame Dimensions for Panel Doors

14

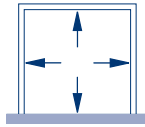

Internal frame size
On-site timber frame
Width x Height
(mm x mm)

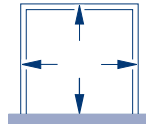

Pre-framed canopy door
overall frame sizes shown¹
Width x Height
(mm x mm)

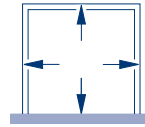

Pre-framed retractable door
overall frame sizes shown¹
Width x Height
(mm x mm)

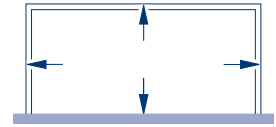

Frame kit for double door
overall frame sizes shown¹
Width x Height
(mm x mm)

Size Code	Width x Height (mm x mm)	Width x Height (mm x mm)	Width x Height (mm x mm)	Width x Height (mm x mm)
6660	1984 x 1830	2094 x 1888	2124 x 1888	-
6663	1984 x 1906	2094 x 1964	2124 x 1964	-
6664	1984 x 1931	2094 x 1989	2124 x 1989	-
6666	1984 x 1981	2094 x 2039	2124 x 2039	-
6670	1984 x 2136	2094 x 2194	2124 x 2194	-
61064	2084 x 1931	2194 x 1989	2224 x 1989	-
61066	2084 x 1981	2194 x 2039	2224 x 2039	-
61070	2084 x 2136	2194 x 2194	2224 x 2194	-
7060	2134 x 1830	2244 x 1888	2274 x 1888	-
7063	2134 x 1905	2244 x 1963	2274 x 1963	-
7064	2134 x 1931	2244 x 1989	2274 x 1989	-
7066	2134 x 1981	2244 x 2039	2274 x 2039	-
7070	2134 x 2136	2244 x 2194	2274 x 2194	-
7076	2134 x 2286	-	2274 x 2344	-
7164	2170 x 1931	2280 x 1989	2310 x 1989	-
7166	2170 x 1981	2280 x 2039	2310 x 2039	-
7170	2170 x 2136	2280 x 2194	2310 x 2194	-
7176	2170 x 2286	-	2310 x 2344	-
7364	2224 x 1931	2334 x 1989	2364 x 1989	-
7366	2224 x 1981	2334 x 2039	2364 x 2039	-
7370	2224 x 2136	2334 x 2194	2364 x 2194	-
7564	2259 x 1931	2369 x 1989	2399 x 1989	-
7566	2259 x 1981	2369 x 2039	2399 x 2039	-
7570	2259 x 2136	2369 x 2194	2399 x 2194	-
7576	2259 x 2286	-	2399 x 2344	-
7664	2284 x 1931	2394 x 1989	2424 x 1989	-
7666	2284 x 1981	2394 x 2039	2424 x 2039	-
7670	2284 x 2136	2394 x 2194	2424 x 2194	-
7676	2284 x 2286	-	2424 x 2344	-
8064	2439 x 1931	2549 x 1989	2579 x 1989	-
8066	2439 x 1981	2549 x 2039	2579 x 2039	-
8070	2439 x 2136	2549 x 2194	2579 x 2194	-
8076	2439 x 2286	-	2579 x 2344	-
8666	2590 x 1981	-	2730 x 2039	-
8670	2590 x 2136	-	2730 x 2194	-
8676	2590 x 2286	-	2730 x 2344	-
9066	2744 x 1981	-	2884 x 2039	-
9070	2744 x 2136	-	2884 x 2194	-
9076	2744 x 2286	-	2884 x 2344	-
1066	3049 x 1981	-	3189 x 2039	-
1070	3049 x 2136	-	3189 x 2194	-
1076	3049 x 2286	-	-	3189 x 2344
1166	3354 x 1981	-	-	3494 x 2039
1170	3354 x 2136	-	-	3494 x 2194
1176	3354 x 2286	-	-	3494 x 2344
1266	3659 x 1981	-	-	3799 x 2039
1270	3659 x 2136	-	-	3799 x 2194
1276	3659 x 2286	-	-	3799 x 2344
1366	3964 x 1981	-	-	4104 x 2039
1370	3964 x 2136	-	-	4104 x 2194
1376	3964 x 2286	-	-	4104 x 2344
1466	4269 x 1981	-	-	4409 x 2039
1470	4269 x 2136	-	-	4409 x 2194
1566	4574 x 1981	-	-	4714 x 2039
1570	4574 x 2136	-	-	4714 x 2194
1576	4574 x 2286	-	-	4714 x 2344
1666	4879 x 1981	-	-	5019 x 2039
1670	4879 x 2136	-	-	5019 x 2194

¹ No fitting clearance allowed. If door is fitted between the brickwork a minimum of 10 mm clearance over the width and 5 mm over the height should be added to the overall frame size when selecting the door.

Side-hinged Garage Door Specifications

Classic

- 50mm frame (standard) 50mm uprights and a 38mm head
- 3/4 steel hinges per side (dependent on size)
- Silver effect nightlatch with white lock body, single point latching
- Bonded steel chassis for strength
- Pair of white polyester painted stays
- Two shoot bolts (inactive leaf)
- Draft strip to all 3 sides
- Bottom weather strip
- Outward opening, right hand leading leaf viewed from outside (Left hand leading or inward opening available - see options right)

Premier

- 50mm frame (standard) 50mm uprights and a 38mm head
- 3/4 brass effect dog bolt hinges per side (dependent on size)
- Brass Eurocylinder nightlatch with double throw deadbolt and multi-point latching
- The rear of the door is reinforced with a steel chassis that is covered with a "flowcoat" of resin for increased rigidity and a neat, light reflecting finish
- Pair of white painted stays
- Two shoot bolts (inactive leaf)
- Draft strip to 3 sides
- Bottom weather strip
- Outward opening, right hand leading leaf viewed from outside (Left hand leading or inward opening available - see options right)

Side-hinged door factory pre-framed

Behind brickwork fixing

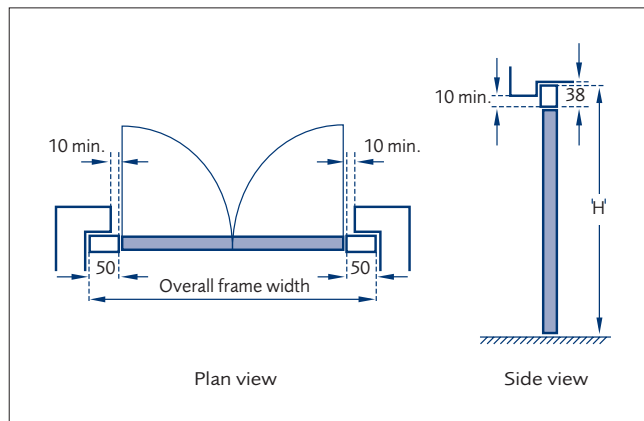

Between brickwork fixing

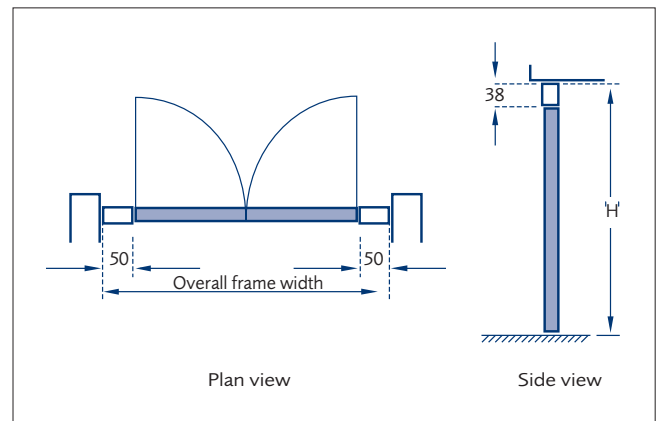

CI/SfB			
127	(31.56)	X	

Date: Dec 2014 Issue 1

Please Note:

- As Wessex GRP Products' policy is one of continuous improvement, we reserve the right to change the specification or withdraw any products without prior notice.
- All details are correct at time of going to press. E & OE.

Product Guarantee – WESSEX GRP PRODUCTS LIMITED. (Wessex)

Subject to conditions set out below;

- Wessex garage doors are guaranteed against any form of manufacturing defect for a period of 2 years from the date of original purchase.
- Wessex electric operators are guaranteed against any form of manufacturing defect for a period of 2 years for mechanical elements, motors and transformers and for a period of 2 years for other electronic and radio equipment.
- The Exterior finish is guaranteed to provide an effective weatherproof membrane which will resist perforation of the substrate from the weather side due to corrosion for the periods indicated below.
2 years - GRP
- Colour change or fade to the exterior surface will be limited and uniform for a period of 2 years.

CONDITIONS

- During the comprehensive 2 year guarantee period Wessex GRP Products Limited undertake to repair or replace (at its discretion), and without charge, products or components which have suffered any form of manufacturing defect. Claims must be notified within 3 days from the date of delivery or within a reasonable time after discovery of any defect.
- Products covered by these guarantees must have been purchased through an authorised Wessex garage door distributor or as original equipment attached to a newly built dwelling.
- The warranties shall apply for normal use only. Normal use constitutes no more than 5 operations (open/close cycles) per day.
- The warranties offered attach to the Wessex product only and no consequential damages will apply no matter how caused.
- No liability will be accepted as a result of normal wear and tear, incorrect storage, incorrect handling, faulty installation, incorrect use, non adherence to routine maintenance schedule or wilful damage..
- Claims under this guarantee must be made through the original supplier and accompanied by relevant documentation indicating the date of purchase (e.g. receipt).
- Wessex GRP Products Limited maximum liability shall be the original purchase price inclusive of Value Added Tax at the rate prevailing when supplied.
- Any product which is the subject of a claim:
 - must have been correctly installed in accordance with the installation instructions supplied and thereafter properly maintained by a suitably experienced engineer on a regular basis as set out in the Maintenance and Operating Instructions provided with every door. (Additional copies of these instructions are available by calling 01942 832 355). We recommend that regular maintenance is provided by a suitably experienced engineer. See your Yellow Pages for your local Wessex Garage Door or AGDS specialist.
 - must have the manufacturers reference number still intact (found on the barcode label on the door)
 - must not have been modified in any way.
- Claims will not be accepted where the cause is due to:
 - impact or mechanical damage suffered during or following installation, e.g. scratches, indentations, tears, scuffs or other surface abrasion.
 - damage or discolouration caused by contact with any form of caustic, abrasive or corrosive substance, fumes, bird droppings, fire, smoke, floodwater, salts, acids, or from exposure to abnormal atmospheric pollution.
- This guarantee excludes normal wear and tear on items such as cones, cables, spindles, lock cylinders, hinges or springs.

- Only Wessex original spare parts must be used when required. The use of non-Wessex parts shall invalidate this guarantee. Warranty period for replacement parts is 6 months or the balance of the original warranty period if greater.
- The Exterior Finish Guarantee applies only to the weatherside surface and where more than 5% of the surface area of the door is affected. Surfaces must be freely exposed to washing by rainfall and kept clear of accumulated dirt and debris and given equal exposure to local environmental conditions and consistent natural lighting conditions across the face of the door. Special attention is drawn to Clause (9) (i).
- The guarantee period for electric operators excludes batteries, fuses and light bulbs.
- Parts replaced free of charge become the property of Wessex GRP Products Limited.
- Attempted repairs by non-qualified individuals shall invalidate this guarantee.
- The specific terms of this guarantee shall only apply to products purchased on or after August 2010 within the UK and Eire.
- Wessex garage doors and associated products are sold subject to the Wessex GRP Products Limited Standard Terms and Conditions of Sale, copies of which are available upon request. Wessex GRP Products Limited shall not be liable as a result of any representation, implied warranty or other term or condition or for any consequential loss or damage, costs, expenses or other claims whatsoever except as expressly set out in these Terms and Conditions of Sale.

General Advice

Door Cleaning

Periodically clean the door panel using warm water and a soft cloth or sponge. Allow to dry naturally. Never use detergent, abrasive, caustic or solvent based cleaners as they may damage the door surface. Bird droppings should be removed immediately as these can be particularly caustic.

Customer Maintenance

Moving parts should be lubricated regularly to ensure smooth operation. Every six months visually inspect all wear items (including cables) for signs of wear. If wear is detected we recommend you contact your local Wessex approved service engineer to arrange for a replacement. Garage door springs are under extreme tension and should only be repaired or replaced by a suitably qualified engineer.

Other performance issues affecting Wessex. garage doors are:

Wessex G.R.P. doors are individually handcrafted products manufactured to specific customer order. Due to the nature of the product and the hand finishing processes used they may occasionally display small blemishes which do not detract from the overall appearance of the product. These are regarded as being within manufacturers tolerance when such blemishes are not visible to the naked eye when viewed from a distance of three metres. Similarly, Woodgrain effect products will, like the natural material, display colour variations across their surface and colour will vary from door to door. Ordering doors to match helps reduce the variation but will not eradicate it entirely.

Translucency of the door panel may vary when viewed from the inside on a bright day due to variations in laminate thickness. This does not represent a manufacturing defect and overall performance is not affected.

Size and Deflection - the natural curing process does not affect the ultimate product size and a tolerance of ± 6 mm on both height and width is deemed acceptable. One piece up and over doors in the 'open' position will display a level of vertical deflection or 'sag' across the width of the panel and up to 6mm per linear metre is within design tolerance.

These terms and conditions do not affect your statutory rights.

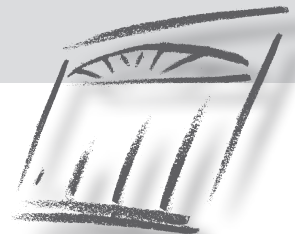

wessex
DOORS