

SeceuroGlide
Garage Doors



January
2025

Retail Price List Garage Doors

www.seceuroglide.co.uk

SWS UK

From security and safety to styles and finishes, SeceuroGlide has it all.

At first glance, you'd be forgiven for assuming that all garage doors are the same. Look a little closer and you'll discover that SeceuroGlide has taken garage door design and technology to the next level.

Developed by industry experts, SeceuroGlide Garage Doors are packed full of clever and unique features, making them the number one choice for quality, safety and security.

- Choice of roller and sectional garage doors
- Electric operation at the touch of a button
- Insulated cores keep the heat in and cold out
- Advanced security features
- Space-saving designs mean you can park right up to your door
- Choice of powerful motors with up to 7-year automation warranty
- Enhanced safety features built in as standard
- 2 stylish handsets included with every door



Product Matrix



SeceuroGlide Roller Garage Doors

	Page	Overguide Width		Guide Height		Secured by Design	LPCB Insurance Approved	Automation Warranty	Headroom (mm)	Lath (mm)	Axle (mm)	End Plates	Locking Straps	Guides (mm)	Finishes	Custom Colour	Vision	Ventilation
		Min (mm)	Max (mm)	Min (mm)	Max (mm)													
Original	6	1050	5400	1500	3700	✓	SRA*	Up to 7 Years	Up to 3m = 300 Over 3m = 350	77	100	Steel	Extruded Aluminium	Up to 3m = 75 Over 3m = 90	28	✓	✓	✓
Excel	6	1500	5200	1000	3500	✓	SR1	Up to 7 Years	Up to 3m = 300 Over 3m = 350	77	100	Steel	Extruded Aluminium	90	28	✓	-	-
LT	10	1050	5200	1500	2650	-	-	5 Years	300	77	70	Aluminium	Plastic with Metal Spring	Up to 3m = 75 Over 3m = 90	28	-	✓	-
Compact	14	1050	3000	1700	2150	-	-	Up to 7 Years	205	55	60	Steel	Plastic with Metal Spring	60	18	-	-	-
Manual	16	1000	3000	1500	2300	-	-	-	300	77	100	Steel	Extruded Aluminium	75	18	-	-	-

SeceuroGlide Sectional Garage Doors

Panel Design	Page	Width (Between Track Legs)		Height (Floor to Underside of Fascia)		NEW Automation Warranty	Colours & Finishes				
		Min (mm)	Max (mm)	Min (mm)	Max (mm)		Standard	Premium	Ultimate	Custom	Windows
Un Ribbed	21	1800	5000	1800	3000	Up to 7 Years	7	14	5	✓	✓
Centre Rib	21	1800	5000	1800	3000	Up to 7 Years	3	16	5	✓	✓
Ribbed	21	1800	5000	1800	3000	Up to 7 Years	3	5	1	✓	✓
Top Ribbed	21	1800	5000	1800	3000	Up to 7 Years	2	10	4	✓	✓
Micro-Rib	21	1800	5000	1800	3000	Up to 7 Years	2	10	4	✓	✓
Georgian	22	2000	5000	1800	3000	Up to 7 Years	1	6	-	✓	✓
Visio	23	1800	4000	1800	2600	Up to 7 Years	5	8	4	✓	✓

See page 30 for additional sectional technical information.



SeceuroGlide Original: Rosewood Woodgrain



SeceuroGlide Manual: Anthracite



An elegantly simple, yet well proven design.

SeceuroGlide is robust, reliable and durable – offering secure protection for your car and home.

A choice of low maintenance finishes, insulation and the convenience of remote automatic operation powered by a high quality SeceuroDrive Motor as standard make SeceuroGlide Roller Garage Doors an excellent all round choice.

SeceuroGlide's aluminium slats lock into position to resist attack by intruders, while advanced insulation and brush sealing keeps out the cold and makes the door as weatherproof as it is secure. Vertical opening means you can make maximum use of your drive and garage space – parking safely just inches from the door.

SeceuroGlide Roller Garage Doors are supplied complete with your choice of remote control, SeceuroSense Plus or Somfy Rollixo. You'll have a choice of handsets and the control equipment will include a courtesy light, bottom slat transmitter, safety edge and manual controls to operate the garage door.

A wide choice of finishes including Woodgrain and Painted Woodgrain help you to match your door to existing paintwork or woodgrain double glazing for a coherent look to your home's exterior. Our SeceuroGlide Original and SeceuroGlide Excel is also available powder coated to any RAL or BS number for a surcharge.

SeceuroGlide Excel combines all the benefits of SeceuroGlide Original with an even higher security specification, and is officially tested and approved to Police and insurance standards. Available at a surcharge on the price of a SeceuroGlide Original.



SeceuroGlide | LT
Standard, Insulated Garage Door

SeceuroGlide | Original
Secure, Insulated Garage Doors



SeceuroGlide | Excel
High Security, Insulated Garage Doors



Aluminium End Plate

Standard, aluminium cast end plate.

Standard Locking System

A 70 mm axle alongside spring loaded plastic locking straps secure the standard SeceuroGlide LT.

Endlocks

Crimped and stapled endlocks used to secure the curtain in operation.

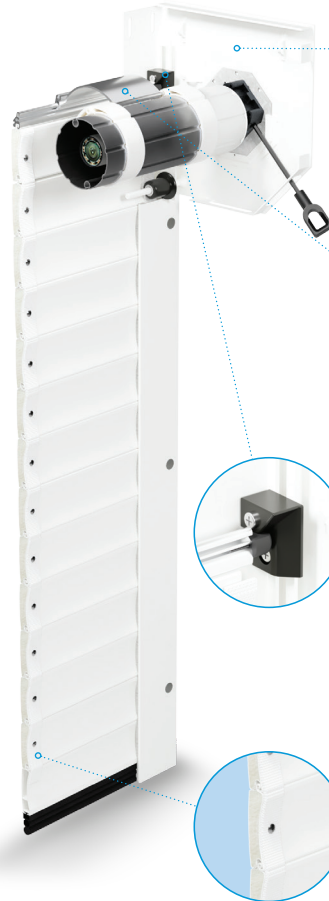

Steel End Plates

Steel end plates on the SeceuroGlide Original & Excel provide a sturdier design and increased security when compared with aluminium end plates.

Strength & Security

100 mm fluted axle, extruded aluminium hinges & top rail, provide greater strength when the door is in operation and in the locked position.

Unique Locking System

Both the Original and the Excel come with auto locking as standard for greater security, preventing the door from being lifted by an intruder. Centralised locking blocks ensure better running of the door during operation.

Security & Noise Reduction

Webbing on each side of the curtain provides additional security whilst also reducing the noise made by the curtain in operation.



Reveal Fit

The SeceuroGlide Excel boasts Secured by Design and insurance approved Level One Security Rating for internal face and reveal fixtures.

Secured by Design

Upgraded 90 mm channels as standard, work alongside locking bottom slats to provide greater security, one of many features which make this door accredited by Secured by Design, even on between fit installations. Locking bottom slat on the SeceuroGlide Excel is designed to prevent the door being pushed out of the guides by an intruder.

SECURE

VERY SECURE

ULTRA SECURE

SeceuroGlide | Original
Secure, Insulated Garage Doors

SeceuroGlide | Excel
High Security, Insulated Garage Doors



SeceuroGlide Original: Anthracite



SeceuroGlide Excel: White

Exceptional design and security.

Since the introduction of our hugely popular SeceuroGlide Original back in 1997, we have gone on to develop a series of garage doors which address everything from security and strength, to aesthetics, clever design and ease of use. In addition to the Secured by Design accreditation of the Original, the Excel also meets the higher specification set by the LPCB to create the most advanced roller door on the market.

Profiles & Sizes

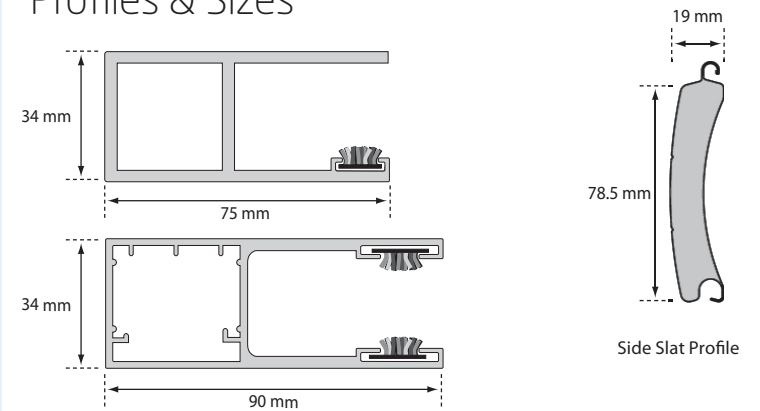

SeceuroGlide Excel guide rail notes:

- 90 mm guide rails supplied as standard on SeceuroGlide Excel.
- Reveal fitted guide rails require steel reinforcement plates.



Unique locking system

Both the Original and the Excel come with auto locking as standard for greater security.



Webbing

Webbing provides additional security, weatherproofing and noise reduction.



Strength and Security

100 mm fluted axle, extruded aluminium hinges and top rail make for a secure operation.

Standard Colours

NO BOX	Overall Guide Width (mm)										Excel max. width		
	1500	2000	2500	3000	3500	4000	4600	5200	5400	5590	Headroom	Total Height	
Guide Width*	75	75	75	75	90	90	90	90	90	90			
Guide Height (mm)	1900	2029	2247	2470	2704	2879	3286	3663	4068	4119	4169	300	2200
	2150	2117	2303	2487	2738	2928	3334	3706	4141	4255		300	2450
	2300	2172	2373	2533	2787	2981	3392	3784	4203	4598		300	2600
	2500	2274	2477	2629	2982	3061	3531	4031	4413	4754		300	2800
	3000	2436	2726	2992	3219	3293	3824	4356	4707			350	3350
	3500	2682	2903	3192	3520	3628	4295					350	3850
3700	2927	3079	3392	3824	3957	4767					350	4050	

Excel max. height

*SeceuroGlide Excel will always be supplied with 90 mm guides

Woodgrain Colours

NO BOX	Overall Guide Width (mm)										Excel max. width		
	1500	2000	2500	3000	3500	4000	4600	5200	5400	5590	Headroom	Total Height	
Guide Width*	75	75	75	75	90	90	90	90	90	90			
Guide Height (mm)	1900	2226	2509	2798	3095	3348	3818	4272	4754	4835	4912	300	2200
	2150	2337	2592	2879	3195	3460	3936	4417	4924	5064		300	2450
	2300	2409	2689	2940	3256	3542	4030	4520	5035	5465		300	2600
	2500	2428	2817	3057	3494	3671	4167	4835	5317	5693		300	2800
	3000	2745	3141	3512	3838	4026	4660	5317	5792			350	3350
	3500	3042	3381	3793	4242	4380	5155					350	3850
3700	3335	3625	4074	4647	4735	5651					350	4050	

Excel max. height

*SeceuroGlide Excel will always be supplied with 90 mm guides

STANDARD COLOURS

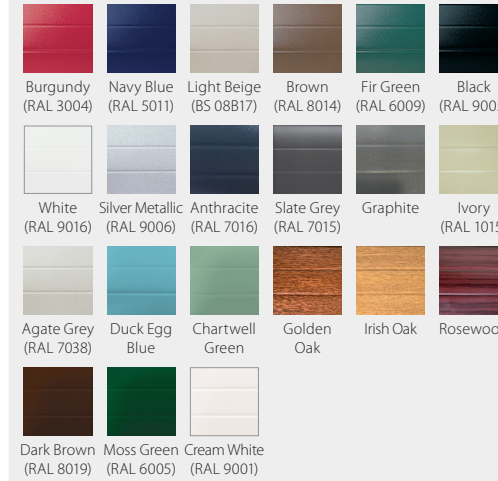

5 YR

Powder coated guide rails, bottom slats and vision slats (where specified) to match the curtain colour are supplied as standard.

End Plates: Galvanised finish as standard. Other colour options are available at a surcharge of **£34.52 per pair**.

Guides Rails: Other non standard colours available at **£51.59 per pair**.

Woodgrain Finishes

Guide Rails and Bottom Slats: Matching woodgrain guide rails and bottom slats are supplied as standard.

End plates: Powder coated to match as standard.

FOILED WOODGRAIN COLOURS



10 YR

Powder coated guide rails, bottom slats and vision slats (where specified) are supplied brown as standard.

End Plates: Galvanised, white, brown or black as standard. Other colour options are available at a surcharge of **£34.52 per pair**.

Guides Rails: Other non standard colours available at **£51.59 per pair**.

Also available in any RAL or BS colour from **£133 per square metre**

EXCEL UPGRADE

Face fit guide rails **£161.30 (pair)**
Reveal fit guide rails **£223.26 (pair)**

Secured by Design
Police Preferred Specification

LPCB
UKAS MANAGEMENT SYSTEMS
0007
Assessed to ISO 9001 & ISO 14001
Cert.LPCB ref. 330

SECEURODRIVE MOTOR

Supplied as standard: FOC

SOMFY MOTOR

Available with a surcharge: **£36 net**

Control Options supplied as standard – choose ONE of the following:

SECEUROSENSE

SECEUROSENSE PLUS

ALARM SURCHARGE

£113.37

SOMFY (Alarm Included)

ROLLIXO PREMIUM RTS

10 UPGRADE

£15 net surcharge

Standard Colours

		Overall Guide Width (mm)							Excel max. width				
HALF BOX		1500	2000	2500	3000	3500	4000	4600	5200	5400	5590	Headroom	Total Height
Guide Width*		75	75	75	75	90	90	90	90	90	90		
Guide Height (mm)	1900	2100	2348	2637	2901	3111	3545	3962	4403	4470	4534	300	2200
	2150	2186	2394	2675	2950	3159	3593	4025	4477	4602		300	2450
	2300	2235	2471	2712	2982	3206	3649	4085	4541	4948		300	2600
	2500	2277	2570	2793	3180	3291	3706	4333	4748	5104		300	2800
	3000	2529	2897	3206	3470	3588	4172	4657	5050			350	3350
	3500	2810	3072	3402	3773	3884	4739					350	3850
	3700	3093	3252	3601	4079	4183	5311					350	4050

Excel max. height

*SeceuroGlide Excel will always be supplied with 90 mm guides

Woodgrain Colours

		Overall Guide Width (mm)							Excel max. width				
HALF BOX		1500	2000	2500	3000	3500	4000	4600	5200	5400	5590	Headroom	Total Height
Guide Width*		75	75	75	75	90	90	90	90	90	90		
Guide Height (mm)	1900	2287	2596	2930	3290	3563	4064	4558	5078	5170	5264	300	2200
	2150	2401	2680	3026	3394	3675	4183	4699	5241	5398		300	2450
	2300	2465	2776	3058	3457	3758	4277	4804	5359	5798		300	2600
	2500	2525	2902	3165	3634	3886	4524	5116	5637	6025		300	2800
	3000	2872	3304	3721	4087	4304	4917	5512	6021			350	3350
	3500	3143	3556	4002	4492	4720	5566					350	3850
	3700	3411	3804	4285	4901	5133	6221					350	4050

Excel max. height

*SeceuroGlide Excel will always be supplied with 90 mm guides

STANDARD COLOURS

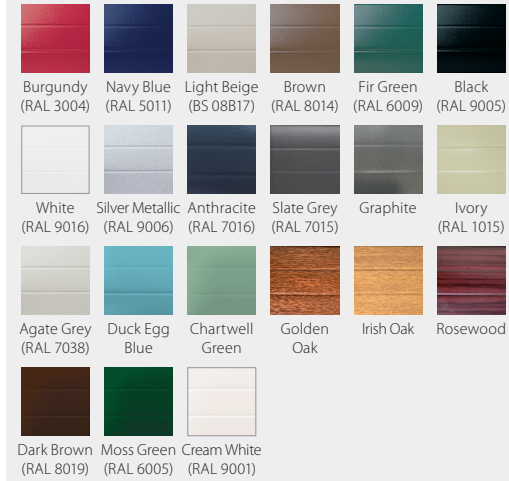

Powder coated guide rails, bottom slats and vision slats (where specified) to match the curtain colour are supplied as standard.

Box & End Plates: White or brown as standard. Other colour options are available at a surcharge of **£39.37 per metre** (includes end plates).

Guides Rails: Other non standard colours available at **£51.59 per pair**.

Woodgrain Finishes

Guide Rails and Bottom Slats: Matching woodgrain guide rails and bottom slats are supplied as standard.

Box: Golden Oak and Rosewood supplied with matching woodgrain box. Irish Oak supplied with a powder coated colour matched box.

End plates: Powder coated to match as standard.

5 YR

FOILED WOODGRAIN COLOURS

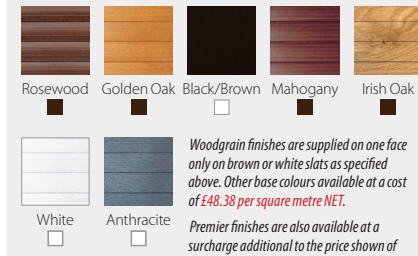

Powder coated guide rails, bottom slats and vision slats (where specified) are supplied brown as standard.

Box: White or brown as standard. Other colour options are available at a surcharge of **£39.37 per metre**.

End Plates: Galvanised, white, brown or black as standard. Other colour options are available at a surcharge of **£34.52 per pair**.

Guides Rails: Other non standard colours available at **£51.59 per pair**.

Woodgrain finishes are supplied on one face only on brown or white slats as specified above. Other base colours available at a cost of £48.38 per square metre NET.

Premier finishes are also available at a surcharge additional to the price shown of £23.41 per square metre.

10 YR

Also available in any RAL or BS colour from **£133 per square metre**

EXCEL UPGRADE

Face fit guide rails **£161.30 (pair)**
Reveal fit guide rails **£223.26 (pair)**



SECEURODRIVE MOTOR

Supplied as standard: FOC

SOMFY MOTOR

Available with a surcharge: **£36 net**

Control Options supplied as standard choose ONE of the following below:

SECEUROSENSE

SECEUROSENSE PLUS
ALARM SURCHARGE
£113.37

SOMFY (Alarm Included)

ROLLIXIO PREMIUM RTS
IO UPGRADE
£15 net surcharge

HALF BOX DIMENSIONS

Supplied pre-built

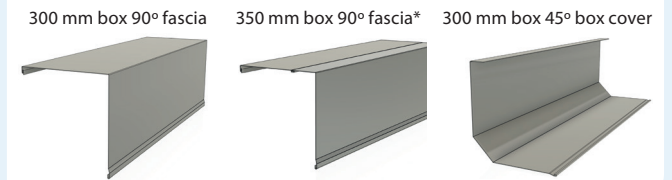

* 90° section of 350 mm box comes in 2 parts

		Overall Guide Width (mm)									Excel max. width			
FULL BOX		1500	2000	2500	3000	3500	4000	4600	5200	5400	5590	Headroom	Total Height	
Guide Width*		75	75	75	75	90	90	90	90	90				
Standard Colours	Guide Height (mm)	1900	2111	2378	2651	2931	3163	3608	4040	4498	4573	4645	300	2200
		2150	2193	2427	2689	2985	3210	3655	4101	4571	4703		300	2450
		2300	2243	2498	2726	3016	3261	3712	4158	4630	5029		300	2600
		2500	2282	2594	2799	3202	3333	3784	4390	4824	5175		300	2800
		3000	2582	2952	3294	3596	3758	4208	4703	5110			350	3350
		3500	2814	3117	3482	3883	4181	4631					350	3850
	3700	3048	3282	3667	4170	4600	5052					350	4050	

*SeceuroGlide Excel will always be supplied with 90 mm guides

		Overall Guide Width (mm)									Excel max. width			
FULL BOX		1500	2000	2500	3000	3500	4000	4600	5200	5400	5590	Headroom	Total Height	
Guide Width*		75	75	75	75	90	90	90	90	90				
Woodgrain Colours	Guide Height (mm)	1900	2303	2633	2966	3308	3592	4100	4606	5141	5239	5572	300	2200
		2150	2410	2711	3043	3410	3700	4212	4739	5295	5455		300	2450
		2300	2472	2803	3105	3468	3782	4305	4843	5403	5833		300	2600
		2500	2530	2923	3210	3693	3900	4431	5138	5667	6052		300	2800
		3000	2882	3349	3788	4190	4433	4985	5597	6119			350	3350
		3500	3163	3578	4058	4576	5234	5811					350	3850
	3700	3446	3812	4324	4961	5500	6089					350	4050	

*SeceuroGlide Excel will always be supplied with 90 mm guides

STANDARD COLOURS

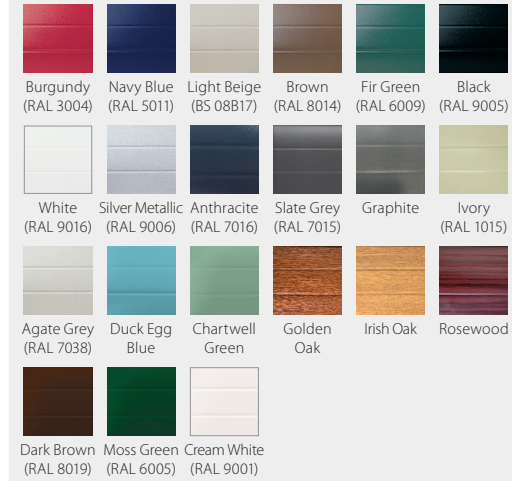

5 YR

Powder coated guide rails, bottom slats and vision slats (where specified) to match the curtain colour are supplied as standard.

Box & End Plates: White or brown as standard. Other colour options are available at a surcharge of **£69.15 per metre** (includes end plates).

Guides Rails: Other non standard colours available at **£51.59 per pair**.

Woodgrain Finishes

Guide Rails and Bottom Slats: Matching woodgrain guide rails and bottom slats are supplied as standard.

Box: Golden Oak and Rosewood supplied with matching woodgrain box. Irish Oak supplied with a powder coated colour matched box.

End plates: Powder coated to match as standard.

FOILED WOODGRAIN COLOURS

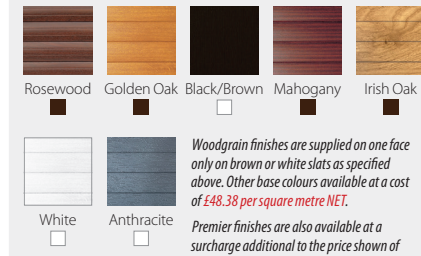

10 YR

Powder coated guide rails, bottom slats and vision slats (where specified) are supplied brown as standard.

Box: White or brown as standard. Other colour options are available at a surcharge of **£69.15 per metre**.

End Plates: Galvanised, white, brown or black as standard. Other colour options are available at a surcharge of **£34.52 per pair**.

Guides Rails: Other non standard colours available at **£51.59 per pair**.

Woodgrain finishes are supplied on one face only on brown or white slats as specified above. Other base colours available at a cost of £48.38 per square metre NET.

Premier finishes are also available at a surcharge additional to the price shown of £23.41 per square metre.

Also available in any RAL or BS colour from **£133 per square metre**

EXCEL UPGRADE

Face fit guide rails **£161.30 (pair)**
Reveal fit guide rails **£223.26 (pair)**

Secured by Design
SBD
Police Preferred Specification

LPCB
UKAS
Assessed to ISO 9001 & ISO 14001
Cert.LPCB ref. 390

SECEURODRIVE MOTOR

Supplied as standard: FOC **SeceuroDrive** Tubular Motor

SOMFY MOTOR

Available with a surcharge: **£36 net** **somfy**

SECEUROSENSE

SECEUROSENSE PLUS

ALARM SURCHARGE

£113.37

SOMFY (Alarm Included)

ROLLIXO PREMIUM RTS

IO UPGRADE

£15 net surcharge

FULL BOX DIMENSIONS Supplied pre-built

Optional Box
'Distance A' = 300 mm
'Distance B' = 350 mm*

*90° section of 350 mm box comes in 2 parts



SeceuroGlide LT: Fir Green



SeceuroGlide LT: Black

The versatile roller garage door.

The entry level SeceuroGlide LT has been created as the perfect solution for those wanting to invest in the look and feel of the SeceuroGlide Original but without a need for all of the high security benefits and built-in noise reduction features offered by the standard SeceuroGlide product. Combining space saving vertical operation with the benefits of an insulated profile and the convenience of electrical operation the SeceuroGlide LT provides a made to measure solution to give lasting value to your property.

Profiles & Sizes

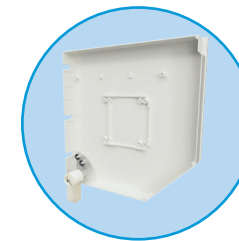
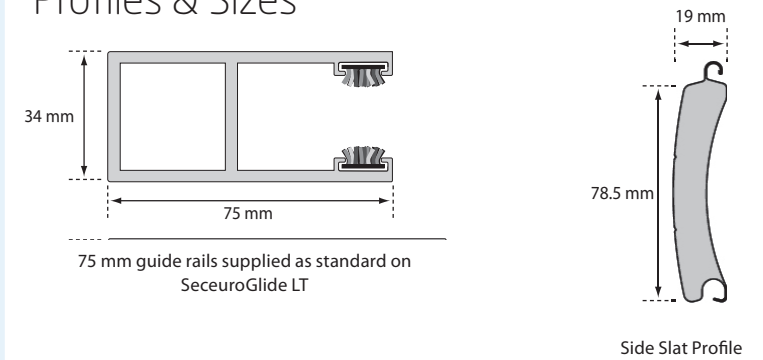

Aluminium End Plate
Standard, aluminium cast end plate.



Standard Locking System
Improved aluminium locking straps secure the LT.



Endlocks
Endlocks used to secure the curtain in operation.

Standard Colours

		Overall Guide Width (mm)											
		NO BOX	2000	2400	2600	3000	3600	4000	4500	4800	5200		
Guide Width		75	75	75	75	90	90	90	90	90	Headroom	Total Height	
Guide Height (mm)	1900	2086	2191	2235	2303	2447	2585	2944	3106	3170	300	2200	
	2150	2128	2252	2308	2360	2557	2804	3160	3322	3478	300	2450	
	2300	2226	2303	2383	2440	2650	2870	3231	3399	3543	300	2600	
	2500	2287	2333	2449	2568	2688	2921	3274	3492		300	2800	
	2650	2347	2436	2552	2622	2740	2968	3358	3520		300	2950	

Woodgrain Colours

		Overall Guide Width (mm)											
		NO BOX	2000	2400	2600	3000	3600	4000	4500	4800	5200		
Guide Width		75	75	75	75	90	90	90	90	90	Headroom	Total Height	
Guide Height (mm)	1900	2368	2555	2650	2883	3204	3393	3667	3820	3873	300	2200	
	2150	2486	2697	2848	3082	3316	3592	3860	3958	4070	300	2450	
	2300	2563	2810	2944	3116	3431	3750	4044	4130	4254	300	2600	
	2500	2650	2931	3079	3318	3666	3942	4148	4320		300	2800	
	2650	2734	3024	3178	3461	3706	4006	4215	4399		300	2950	

STANDARD COLOURS

Burgundy (RAL 3004) Navy Blue (RAL 5011) Light Beige (BS 08B17) Brown (RAL 8014) Fir Green (RAL 6009) Black (RAL 9005)
 White (RAL 9016) Silver Metallic (RAL 9006) Anthracite (RAL 7016) Slate Grey (RAL 7015) Graphite Ivory (RAL 1015)
 Agate Grey (RAL 7038) Duck Egg Blue Chartwell Green Golden Oak Irish Oak Rosewood
 Dark Brown (RAL 8019) Moss Green (RAL 6005) Cream White (RAL 9001)

Powder coated bottom slats and vision slats (where specified) to match the curtain colour are supplied as standard.

End Plates: Aluminium, white or brown as standard. Other colour options are available at a surcharge of **£34.52 per pair**.

Guides Rails: White or Brown as standard. Other colour options are available at a surcharge of **£51.59 per pair**.

Vision slats and guide rails are not available in painted woodgrain finishes.



FOILED WOODGRAIN COLOURS

Rosewood Golden Oak Black/Brown Mahogany Irish Oak
 White Anthracite

Powder coated guide rails, bottom slats and vision slats (where specified) are supplied brown as standard.

End Plates: Aluminium, white or brown as standard. Other colour options are available at a surcharge of **£34.52 per pair**.

Guides Rails: White or Brown as standard. Other colour options are available at a surcharge of **£51.59 per pair**.

Woodgrain finishes are supplied on one face only on brown or white slats as specified above. Other base colours available at a cost of £48.38 per square metre NET.

Premier finishes are also available at a surcharge additional to the price shown of £23.41 per square metre.



SECEURODRIVE MOTOR

Supplied as standard: FOC **SeceuroDrive** Tubular Motor

SOMFY MOTOR

Available with a surcharge: **£36 net**

Control Options supplied as standard – choose ONE of the following:

SECEUROSENSE



ALARM SURCHARGE
£113.37

SOMFY (Alarm Included)



IO UPGRADE
£15 net surcharge
Or Rollixo Optimo with Smooove Origin Wall Switch for a reduction of **£20 net**

Overall Guide Width (mm)

Standard Colours	HALF BOX	2000	2400	2600	3000	3600	4000	4500	4800	5200	Headroom	Total Height
	Guide Width	75	75	75	75	90	90	90	90	90		
Guide Height (mm)	1900	2127	2294	2288	2470	2722	2864	3078	3197	3207	300	2200
	2150	2185	2399	2480	2636	2854	3045	3293	3367	3543	300	2450
	2300	2241	2471	2545	2684	2976	3155	3389	3431	3603	300	2600
	2500	2324	2510	2633	2761	3066	3283	3460	3546		300	2800
	2650	2374	2539	2697	2866	3122	3372	3507	3678		300	2950

Overall Guide Width (mm)

Woodgrain Colours	HALF BOX	2000	2400	2600	3000	3600	4000	4500	4800	5200	Headroom	Total Height
	Guide Width	75	75	75	75	90	90	90	90	90		
Guide Height (mm)	1900	2499	2711	2816	3071	3431	3641	3944	4116	4189	300	2200
	2150	2582	2853	3011	3275	3540	3905	4212	4330	4472	300	2450
	2300	2658	2954	3111	3385	3631	3980	4398	4505	4660	300	2600
	2500	2784	3031	3248	3510	3796	4066	4501	4698		300	2800
	2650	2868	3183	3346	3654	3942	4211	4568	4778		300	2950

STANDARD COLOURS



Powder coated bottom slats and vision slats (where specified) to match the curtain colour are supplied as standard.

Box: White or Brown as standard. Other colour options are available at a surcharge of **£39.37 per metre**.

End Plates: Aluminium, white or brown as standard. Other colour options are available at a surcharge of **£34.52 per pair**.

Guides Rails: White or Brown as standard. Other colour options are available at a surcharge of **£51.59 per pair**.

Vision slats and guide rails are not available in painted woodgrain finish.



FOILED WOODGRAIN COLOURS

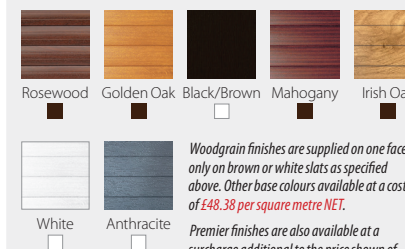

Powder coated guide rails, bottom slats and vision slats (where specified) are supplied brown as standard.

Box: White or brown as standard. Other colour options are available at a surcharge of **£39.37 per metre**.

End Plates: Aluminium, white or brown as standard. Other colour options are available at a surcharge of **£34.52 per pair**.

Guides Rails: White or Brown as standard. Other colour options are available at a surcharge of **£51.59 per pair**.



SECEURODRIVE MOTOR

Supplied as standard: FOC **SeceuroDrive** Tubular Motor

SOMFY MOTOR

Available with a surcharge: **£36 net**

Control Options supplied as standard choose ONE of the following below:

SECEUROSENSE

SECEUROSENSE PLUS
ALARM SURCHARGE
£113.37

SOMFY (Alarm Included)

ROLLIXIO PREMIUM RTS IO UPGRADE
£15 net surcharge
Or Rollixio Optimo with Smooove Origin Wall Switch for a reduction of **£20 net**

HALF BOX OPTIONS

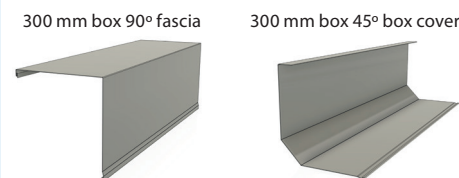

BOX MADE UP AS STANDARD

Boxes for SeceuroGlide LT come made up as standard. If you do not wish to take advantage of this manufacturing process, there will be a **£15 net discount**.

Overall Guide Width (mm)

Standard Colours	FULL BOX	2000	2400	2600	3000	3600	4000	4500	4800	5200	Headroom	Total Height
	Guide Width	75	75	75	75	90	90	90	90	90		
Guide Height (mm)	1900	2159	2330	2400	2602	2879	3039	3350	3406	3437	300	2200
	2150	2237	2492	2576	2786	3062	3220	3503	3551	3612	300	2450
	2300	2292	2554	2655	2868	3134	3328	3604	3643	3736	300	2600
	2500	2345	2578	2698	2919	3222	3459	3652	3755		300	2800
	2650	2405	2640	2765	2995	3278	3527	3682	3781		300	2950

Overall Guide Width (mm)

Woodgrain Colours	FULL BOX	2000	2400	2600	3000	3600	4000	4500	4800	5200	Headroom	Total Height
	Guide Width	75	75	75	75	90	90	90	90	90		
Guide Height (mm)	1900	2586	2819	2932	3208	3389	3826	4152	4338	4432	300	2200
	2150	2660	2933	3130	3280	3493	4090	4421	4554	4712	300	2450
	2300	2730	3020	3228	3363	3582	4250	4604	4727	4900	300	2600
	2500	2808	3122	3364	3592	3699	4362	4707	4917		300	2800
	2650	3202	3406	3464	3813	4182	4513	4776	4997		300	2950

STANDARD COLOURS



5 YR

Powder coated bottom slats and vision slats (where specified) to match the curtain colour are supplied as standard.

Box: White or Brown as standard. Other colour options are available at a surcharge of **£69.15 per metre**.

End Plates: Aluminium, white or brown as standard. Other colour options are available at a surcharge of **£34.52 per pair**.

Guides Rails: White or Brown as standard. Other colour options are available at a surcharge of **£51.59 per pair**.

Vision slats and guide rails are not available in painted woodgrain finish.

FOILED WOODGRAIN COLOURS

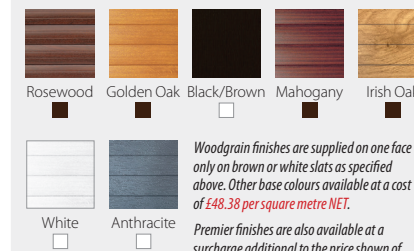

10 YR

Powder coated guide rails, bottom slats and vision slats (where specified) are supplied brown as standard.

Box: White or brown as standard. Other colour options are available at a surcharge of **£69.15 per metre**.

End Plates: Aluminium, white or brown as standard. Other colour options are available at a surcharge of **£34.52 per pair**.

Guides Rails: White or Brown as standard. Other colour options are available at a surcharge of **£51.59 per pair**.

Woodgrain finishes are supplied on one face only on brown or white slats as specified above. Other base colours available at a cost of £48.38 per square metre NET.

Premier finishes are also available at a surcharge additional to the price shown of £23.41 per square metre.

SECEURODRIVE MOTOR

Supplied as standard: FOC **SeceuroDrive** Tubular Motor

SOMFY MOTOR

Available with a surcharge: **£36 net**

Control Options supplied as standard choose ONE of the following below:

SECEUROSENSE

SECEUROSENSE PLUS

ALARM SURCHARGE

£113.37

SOMFY (Alarm Included)

ROLLIXO PREMIUM RTS IO UPGRADE

£15 net surcharge

Or Rollixxo Optimo with Smooove Origin Wall Switch for a reduction of **£20 net**

FULL BOX OPTIONS

'Distance A' = 300 mm

BOX MADE UP AS STANDARD

Boxes for SeceuroGlide LT come made up as standard.

If you do not wish to take advantage of this manufacturing process, there will be a **£15 net discount**.



SeceuroGlide Compact: White Colour Finish



SeceuroGlide Compact: White Colour Finish

SeceuroGlide Compact internal/external fitting roller garage door.

The SeceuroGlide Compact has been developed especially for garages with limited headroom. SeceuroGlide Compact's insulated aluminium slats are narrower than those used for the SeceuroGlide allowing a tighter, smaller coil which requires just 8" (205 mm) clearance above the opening height. An extensive range of sizes also means openings of up to 3000 mm wide (Overall Guide Width) can be accommodated.

Profiles & Sizes

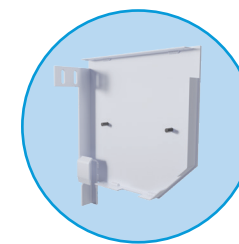
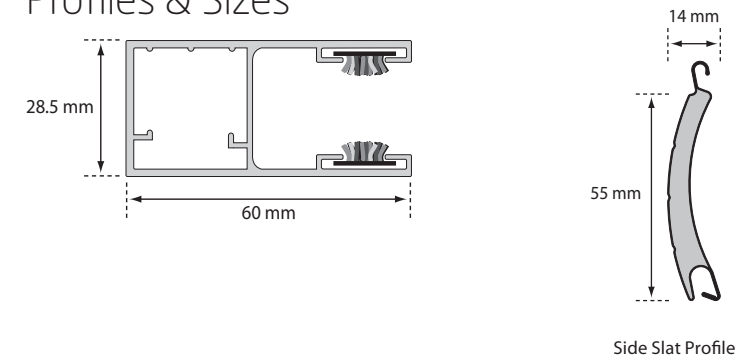

Steel End Plate
Extruded steel end plates for added strength and durability.



Improved Locking System
Improved locking system with reinforced locking straps for added peace-of-mind security.

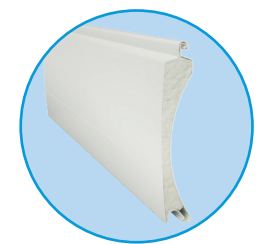

Slimline Design
Slimline insulated slats reduce headroom space needed by 31%.

Standard Colours

Overall Guide Width (mm)

HALF BOX		2000	2500	3000	Headroom	Total Height
Guide Width		60	60	60		
Guide Height (mm)	1900	2143	2272	2476	205	2105
	2150	2178	2298	2517	205	2355
FULL BOX		2000	2500	3000	Headroom	Total Height
Guide Width		60	60	60		
Guide Height (mm)	1900	2200	2323	2513	205	2105
	2150	2230	2359	2553	205	2355

Woodgrain Colours

Overall Guide Width (mm)

HALF BOX		2000	2500	3000	Headroom	Total Height
Guide Width		60	60	60		
Guide Height (mm)	1900	2375	2565	2827	205	2105
	2150	2437	2639	2909	205	2355
FULL BOX		2000	2500	3000	Headroom	Total Height
Guide Width		60	60	60		
Guide Height (mm)	1900	2417	2601	2847	205	2105
	2150	2476	2676	2927	205	2355

STANDARD COLOURS

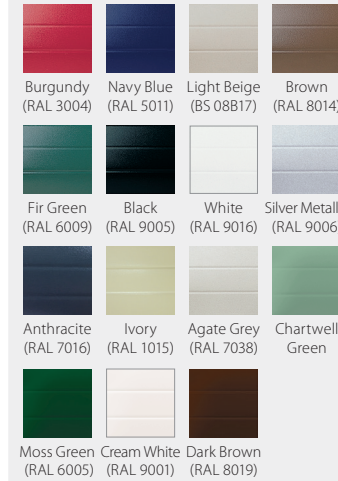

Powder coated bottom slats to match the curtain colour are supplied as standard.

Half Box: White, Brown or Fir Green as standard. Other colour options are available at a surcharge of **£39.37 per metre**.

Full Box: White, Brown or Fir Green as standard. Other colour options are available at a surcharge of **£69.15 per metre**.

End Plates: White, Brown or Fir Green as standard. Other colour options are available at a surcharge of **£34.52 per pair**.

Guides Rails: White, Brown or Fir Green as standard. Other colour options are available at a surcharge of **£51.59 per pair**.



FOILED WOODGRAIN COLOURS

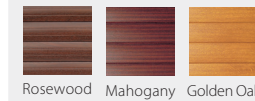

Powder coated guide rails and bottom slats are supplied brown as standard.

Half Box: White, Brown or Fir Green as standard. Other colour options are available at a surcharge of **£39.37 per metre**.

Full Box: White, Brown or Fir Green as standard. Other colour options are available at a surcharge of **£69.15 per metre**.

End Plates: White, Brown or Fir Green as standard. Other colour options are available at a surcharge of **£34.52 per pair**.

Guides Rails: White, Brown or Fir Green as standard. Other colour options are available at a surcharge of **£51.59 per pair**.

SECEURODRIVE MOTOR

Supplied as standard: FOC **SeceuroDrive**
Tubular Motor

SOMFY MOTOR

Available with a surcharge of: **£36 net**

Control Options supplied as standard – choose ONE of the following:

SECEUROSENSE



ALARM SURCHARGE
£113.37

SOMFY (Alarm Included)



IO UPGRADE
£15 net surcharge

HALF BOX DIMENSIONS

205 mm box 90° fascia



Supplied pre-built

FULL BOX DIMENSIONS

'Distance A'
= 205 mm

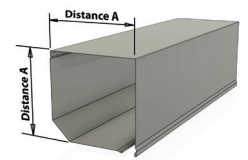

Supplied pre-built



SeceuroGlide Manual: Agate Grey Colour Finish



SeceuroGlide Manual: Anthracite Colour Finish

SeceuroGlide Manual the only insulated manual roller garage door on the market.

Developed to the same high standards and build quality as the SeceuroGlide range, SeceuroGlide Manual offers the ideal solution for applications where electricity is not available. The SeceuroGlide Manual has been engineered with ease of use in mind to provide the smoothest operation, whilst still offering the high levels of security and insulation.

Profiles & Sizes

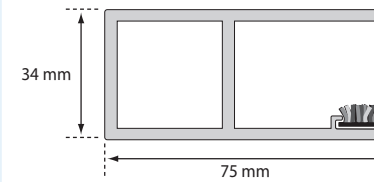

75 mm guide rails supplied as standard on SeceuroGlide Manual

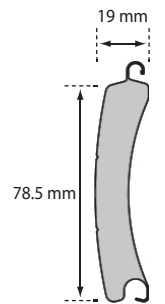

Side Slat Profile



Smooth Operation

The rolling bracket ensures smooth operation and reduces wear.



Strengthening Bottom Slat

Patented bottom slat profile provides strength and aids operation.



Insulated Slats

Foam filled aluminium slats.

Overall Guide Width (mm)

		NO BOX	1000	1500	2000	2500	3000		
Standard Colours	Guide Width		75	75	75	75	75	Headroom	Total Height
	Guide Height (mm)	1900	1266	1479	1691	1917	2154	300	2200
		2150	1331	1565	1745	1956	2204	300	2450
		2300	1406	1614	1824	1996	2221	300	2600

STANDARD COLOURS



Powder coated guide rails and bottom slats to match the curtain colour are supplied as standard.

End Plates: Aluminium, white or brown as standard. Other colour options are available at a surcharge of **£34.52 per pair**.

Guides Rails: Other non standard colours available at **£51.59 per pair**.

PLEASE NOTE: Painted Woodgrains and Foiled Woodgrain Colours are not available on our SeceuroGlide Manual Garage Door.



KEY OPERATION

The key operated lock is located in the middle of the door. Integrated handles are located in the middle and at the bottom for convenient operation from inside or outside the garage.



In partnership with the Weather Defender

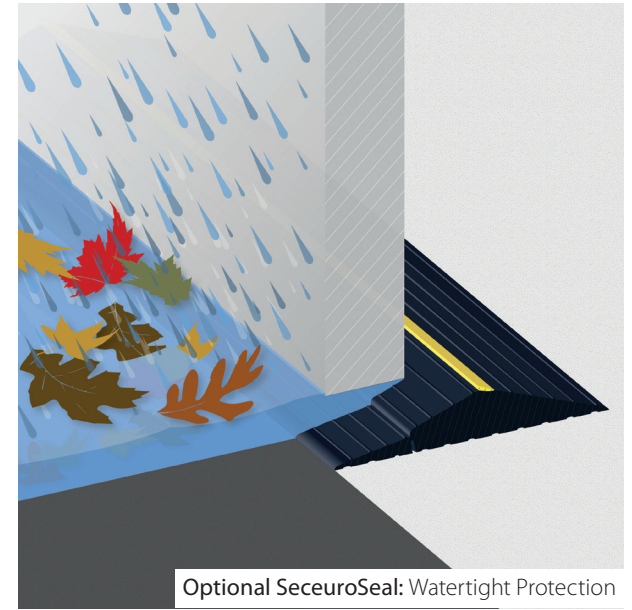

SECEUROSEAL

SeceuroSeal provides a watertight seal and a physical barrier to prevent water and debris entering the garage. Particularly useful for garages with uneven floors, or those that lie at the bottom of a sloping driveway, SeceuroSeal is fitted on the ground underneath the door and has been developed to ensure garages are kept dry and clean, even in the worst of the British weather.

SeceuroSeal is supplied flat in pre-cut lengths for **£27.90 per metre**. SeceuroSeal Adhesive (290ml) is available for **£18.16 each**.

ROLLER OPTIONS & ACCESSORIES





IMAGE	DESCRIPTION	PROFILE	STOCK CODE	PRICE (£)
OPTIONAL EXTRAS				
	Fitted manual override lock (SeceuroGlide Compact Only)	each	YSGACCS1 O/R LOK	180.10
	90 mm guides (upgrade from 75 mm guides)	per door	YSGACCS1 90 GUIDE	109.09
	SLOPING BOTTOM SLAT: Not available on Excel (please use order form) Overall door width from 0 to 5000 mm <i>Online prices per linear metre @ £115.44 when specified with door</i>	per linear metre	YACCS SLOPE	158.91
	SeceuroGlide Vision Slat (punched and glazed) Available Inline or Brick Bond	per linear metre	YSGACCS1 VISION	21.74
	SeceuroGlide Vented Slat* *Not available in Renolit or Painted Woodgrain finishes	per linear metre	SL777VS VENTED	66.82
	300 mm 90° fascia box support (4 required up to 3000 mm, 6 required – 3001 to 5400 mm)	each	BX000B0	9.61
	Emergency low level external manual override kit	each	MT120M1	275.00
	Spacer Block for Low Level Override	each	BS781B0	14.99
	Loose manual override exit lock	each	MT018A1	75.77
	SeceuroSeal	per metre	BS810B0	27.90
	SeceuroSeal Adhesive (290ml)	each	BS810B1	18.16
ALUMINIUM BOX AND ANGLES				
	30 x 20 Aluminium L Section Angle (Mill Finish) 30 x 20 Aluminium L Section Angle Powder Coated (White) 30 x 20 Aluminium L Section Angle Powder Coated (Brown)	per metre	YBS300E0 YBS300E1 YBS300E2	14.25
	50 x 20 Aluminium Box Section/Packer (Mill Finish) 50 x 20 Aluminium Box Section/Packer Powder Coated (White) 50 x 20 Aluminium Box Section/Packer Powder Coated (Brown)	per metre	YBS520E0 YBS520E1 YBS520E2	26.36
	50 x 50 Aluminium Box Section/Packer (Mill Finish) 50 x 50 Aluminium Box Section/Packer Powder Coated (White) 50 x 50 Aluminium Box Section/Packer Powder Coated (Brown)	per metre	YBS550E0 YBS550E1 YBS550E2	33.00
OTHER CONTROL OPTIONS				
	Keyswitch	each	EC381O3	102.99
	Keyswitch Keyed Different	each	EC381O2	97.37
	SO12 Flush Front Plate	each	EC381O4	8.75
	Tubular Motor Test Lead	each	EC409O0	125.35

IMAGE	DESCRIPTION	PROFILE	STOCK CODE	PRICE (£)
SECEUROGLIDE & SECEUROGLIDE COMPACT LATH REPLACEMENTS				
	SeceuroGlide cut Slat (Standard colours)	per metre	YSL770A1	16.09
	SeceuroGlide cut Slat (Woodgrain colours)	per metre	YSL770A2	25.72
	SeceuroGlide Compact cut Slat (Standard colours)	per metre	YSL30A1	7.47
	SeceuroGlide Compact cut Slat (Woodgrain colours)	per metre	YSL30A2	24.73
SECEUROGLIDE CURTAINS				
	SECEUROGLIDE READY MADE CURTAIN (The surcharge does not include the cost of safety edge this needs to be added on (cut out for the RDU is included if needed)) Standard colours Woodgrain Foiled Woodgrains	per metre square	SGLIDE CD77 CURT WOODGRAIN	226.69 283.27
	SECEUROGLIDE COMPACT READY MADE CURTAIN (The surcharge does not include the cost of safety edge this needs to be added on (cut out for the RDU is included if needed)) Standard colours Woodgrain	per metre square	CURT CD300 WOODGRAIN	195.34 245.47
UPGRADE KITS				
	SeceuroSense Plus Wireless Upgrade Kit	each	EC699O3	470.08
	SeceuroSense Plus Wired Upgrade Kit	each	EC699O2	470.08
	Somfy Rollixo Garage Door Remote Control Upgrade Kit	each	EC499O0	467.54
	AEGDW Bottom Slat	per metre	YBS005E1	45.00
	Triple Chamber Rubber Seal	per metre	BS730B0	28.24
	Radio Card & BST Upgrade Kit	each	EC990O0	332.94
TOUCH-UP PAINT POT & PEN				
	TOUCH-UP PAINT POT Anthracite (RAL7016), Black (RAL9005), Brown (RAL8014), Burgundy (RAL3004), Duck Egg Blue, Chartwell Green (BS14C35), Fir Green (RAL6009), Graphite (RAL7024), Heritage Green (RAL6021), Ivory (RAL1015), Light Beige (BS08B17), Agate Grey (RAL7038), Navy Blue (RAL5011), Silver Metallic (RAL9006), White (RAL9016)	each	PC500XX	8.22
	TOUCH-UP PAINT PEN Anthracite (RAL7016), Black (RAL9005), Brown (RAL8014), Burgundy (RAL3004), Light Beige (BS08B17), Agate Grey (RAL7038), Silver Metallic (RAL9006)	each	PC502PX	32.98
COVERCAPS				
	13 MM COVERCAPS Brown, Black, Blue, Cream, Dark Grey, Grey, Light Green, Red, White	each	GU010XX	0.21

Drive Through & Total Sizing:

- Drive through width = Over guide width minus (guide width x 2)
- Drive through height = Guide height minus hangdown
- Total/overall height = Guide height plus headroom

	Width Priced on over guide width				Hangdown	Height Priced on guide height	
	Guides					Up to 2500	Up to 3500
	Up to 3000	Up to 4600	Up to 5200	Up to 5590			
Excel	90	90	90		110	300	350
Original	75	90	90	90	110	300	350
LT	75	90	90		110	300	
Compact	60				90	205	
Manual	75				105	300	

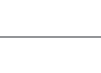
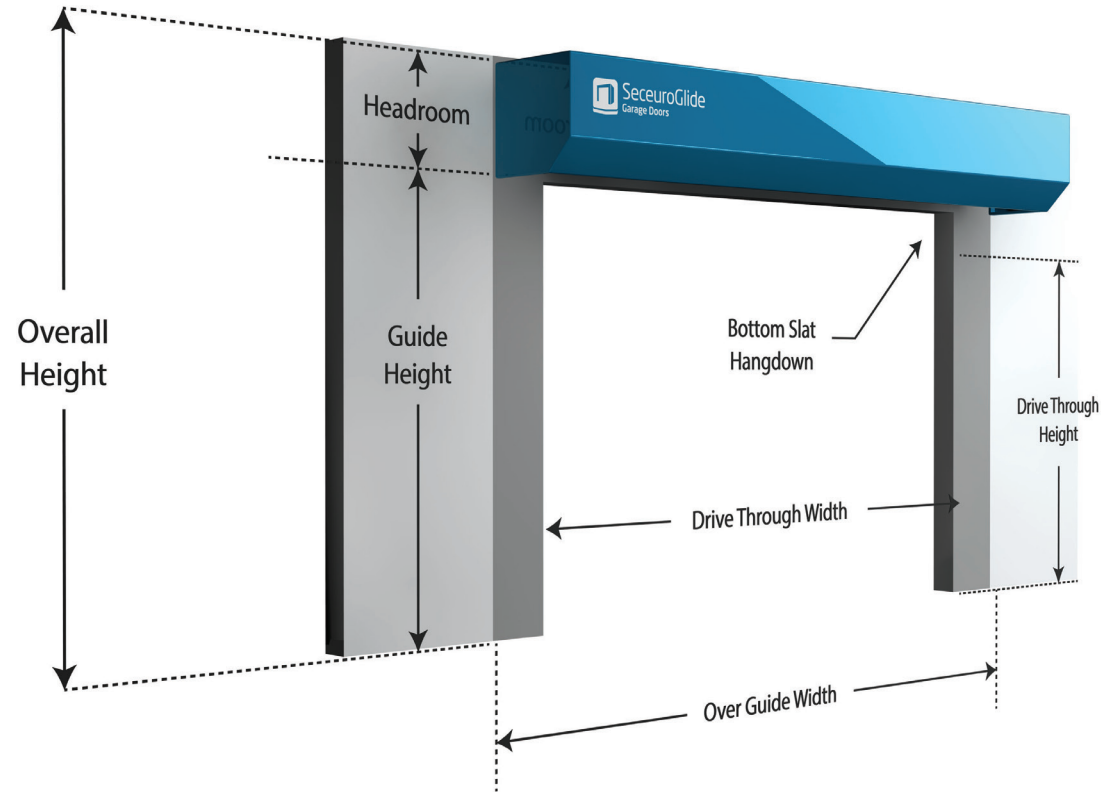

Minimum and maximum sizes across the range:

	Over guide width (mm)		Guide Height (mm)	
	Min	Max	Min	Max
Excel	1500	5200	1500	3500
Original	1050	5590	1500	3700
LT	1050	5200	1500	2650
Compact	1050	3000	1700	2150
Manual	1000*	3000	1500	2300

*Minimum width above 2150 mm guide height = 1100 mm



NEW Anthracite Smooth Visio

Make an Entrance with SeceuroGlide Sectional Garage Doors.

By choosing a SeceuroGlide Sectional garage door, you are investing in a product that has it all; security, kerb-appeal, ease of operation and choice.

Providing reliable performance when you need it most, SeceuroGlide Sectionals are designed to accommodate everyday modern life, yet every bespoke door can be configured to match your own personal style and requirements. With an emphasis on choice, you are in control of how your door is operated (choose from manual or electric) and with an extensive choice of colours, finishes, panels and accessories, how your door looks is down to you.

Good looks doesn't mean a compromise on safety as every electrically operated SeceuroGlide Sectional has obstacle detection built into the motor, which means it will never close when anything is detected in its path, providing perfect peace of mind for all the family.



Black Woodgrain Embossed Georgian Cassette



NEW Anthracite Ribbed with Wicket Door



NEW Anthracite Smooth Un-Ribbed with Lineo



CUSTOM COLOUR Flame Red Smooth Centre Ribbed



Anthracite Dura Un-Ribbed



Only SeceuroGlide offers a **7-year automation warranty** when you choose a Somfy Dexxo operator to motorise your door.

7 YR WARRANTY

somfy.

STANDARD PANELS

Premium Colours £65/m²
 Ultimate Colours £81/m²
 Any RAL £81/m²
 See page 24 for the full colour range



Un-Ribbed
Plain or Woodgrain



Centre Ribbed
Plain or Woodgrain



Ribbed
Woodgrain



Top Ribbed
Plain



Micro-Rib
Plain

Panel Styles

Between Track Width: Min 1800 mm, Max 5000 mm | Height: Min 1800 mm, Max 3000 mm | Wicket Door: Min Width 2140 mm, Min Height 1960 mm

Side Cover Profiles
40 mm & 100 mm (per side)

Floor To Underside Of Fascia (height)

	2134 mm / 7ft	2286 mm / 7ft 6in	2438 mm / 8ft	2591 mm / 8ft 6in	2743 mm / 9ft	3048 mm / 10ft	3250 mm / 12ft 6in	3353 mm / 11ft	3658 mm / 12ft	3962 mm / 13ft	4267 mm / 14ft	4420 mm / 14ft 6in	4572 mm / 15ft	4725 mm / 15ft 6in	4877 mm / 16ft	5000 mm / 16ft 5in
1981 mm / 6ft 6in	1529	1573	1623	1686	1735	1850	1914	1990	2063	2122	2288	2329	2381	2458	2578	2602
2134 mm / 7ft	1650	1707	1758	1822	1889	2013	2095	2155	2213	2302	2469	2525	2595	2674	2795	2846
2235 mm / 7ft 4in	1719	1787	1839	1902	1983	2115	2193	2220	2244	2338	2505	2548	2635	2790	2822	2933
2438 mm / 8ft	1747	1822	1879	1957	2018	2156	2233	2303	2376	2479	2648	2728	2789	2884	3031	3255
2500 mm / 8ft 2in	1758	1833	1892	1964	2024	2164	2251	2314	2381	2483	2663	2760	2795	2889	3045	3269
3000 mm / 9ft 10in	2013	2088	2164	2235	2326	2505	2595	2701	2786	2907	3140	3414				

Sizes available with a wicket door

Black/White/Anthracite	To Match Door
53	68
57	74
59	77
65	83
67	87
80	103

NEW Wicket door surcharge £1702
 See page 28 for more information.

Lintel Profile 60/90/100/130 mm

Between Track Legs (width)

	2134 mm / 7ft	2286 mm / 7ft 6in	2438 mm / 8ft	2591 mm / 8ft 6in	2743 mm / 9ft	3048 mm / 10ft	3250 mm / 12ft 6in	3353 mm / 11ft	3658 mm / 12ft	3962 mm / 13ft	4267 mm / 14ft	4420 mm / 14ft 6in	4572 mm / 15ft	4725 mm / 15ft 6in	4877 mm / 16ft	5000 mm / 16ft 5in
Black/White/Anthracite	70	79	89	100	110	128	144	157	178	204	229	249	272	295	318	343
To Match Door	128	144	162	180	202	236	263	284	327	371	419	455	495	537	582	626

Reveal Fitting Kits

Executive Framing Kits		
Single Executive Full Framing Kit (width up to 3000 mm)	Black/White/Anthracite	533.42
	To Match Door	666.77
Double Executive Full Framing Kit (width 3001 mm to 4420 mm)	Black/White/Anthracite	684.96
	To Match Door	812.25
Large Double Executive Full Framing Kit (width 4420 mm +)	Black/White/Anthracite	751.63
	To Match Door	921.36
Basic Reveal Fixing Kits		
Brackets, Rivets, Nuts & Bolts	Loose	77.59

Windows

See page 27 for further window information.

PVC Frames	Glazing		
Rectangular	Polycarbonate	Clear or Granite	108
		Inset Design (surcharge)	12
Round	Double Glazing	Clear or Frosted	144
	Polycarbonate	Clear or Textured	96
Brushed Aluminium Frames		Glazing	
Round	Double Glazing	Clear	326
		Frosted	347
Square	Double Glazing	Clear	280
		Frosted	304
Line NEW	Triple Glazing	Frosted	783

Brushed Aluminium Decals **NEW**

Available on smooth or sandgrain Un-Ribbed panels only. See page 26 for further window information.

Ellipse, Duo, Finesse, Flower, Line, Line Large, Lineo, Lineo Large, Stems, Trapezium, Wave	304
Curve, Sunbeam, Sunrise	529

GEORGIAN CASSETTE

Premium Colours £65/m²
Any RAL £81/m²
See page 24 for the full colour range



Panel Style Georgian Cassette

Woodgrain only

Between Track Width: Min 2000 mm, Max 5000 mm | Height: Min 1800 mm, Max 3000 mm

Side Cover Profiles
40 mm & 100 mm (per side)

Black/White/ Anthracite	To Match Door
53	68
57	74
59	77
65	83
67	87
80	103

Floor To Underside Of Fascia (height)

	2134 mm / 7ft	2286 mm / 7ft 6in	2438 mm / 8ft	2591 mm / 8ft 6in	2743 mm / 9ft	3048 mm / 10ft	3250 mm / 12ft 6in	3353 mm / 11ft	3658 mm / 12ft	3962 mm / 13ft	4267 mm / 14ft	4420 mm / 14ft 6in	4572 mm / 15ft	4725 mm / 15ft 6in	4877 mm / 16ft	5000 mm / 16ft 5in
1981 mm / 6ft 6in	1891	1938	1985	2019	2096	2210	2256	2273	2404	2479	2542	2583	3205	3330	3398	3422
2134 mm / 7ft	1974	2019	2072	2107	2221	2310	2358	2380	2513	2597	2664	2763	3636	3671	3730	3756
2235 mm / 7ft 4in	1974	2019	2072	2107	2221	2310	2358	2380	2513	2597	2664	2651	3643	3780	3840	3866
2438 mm / 8ft	2086	2118	2171	2215	2341	2442	2497	2519	2636	2726	2860	2989	3722	3859	3919	3944
2500 mm / 8ft 2in	2086	2118	2171	2215	2341	2442	2497	2519	2636	2726	2906	3032	3738	3875	3935	3961
3000 mm / 9ft 10in	2426	2456	2537	2503	2608	2788	2949	2999	3240	3370	3559	3690				

Lintel Profile 60/90/100/130 mm

Between Track Legs (width)

	2134 mm / 7ft	2286 mm / 7ft 6in	2438 mm / 8ft	2591 mm / 8ft 6in	2743 mm / 9ft	3048 mm / 10ft	3250 mm / 12ft 6in	3353 mm / 11ft	3658 mm / 12ft	3962 mm / 13ft	4267 mm / 14ft	4420 mm / 14ft 6in	4572 mm / 15ft	4725 mm / 15ft 6in	4877 mm / 16ft	5000 mm / 16ft 5in
Black/White/Anthracite	70	79	89	100	110	128	144	157	178	204	229	249	272	295	318	343
To Match Door	128	144	162	180	202	236	263	284	327	371	419	455	495	537	582	626

Reveal Fitting Kits

Executive Framing Kits		
Single Executive Full Framing Kit (width up to 3000 mm)	Black/White/Anthracite	533.42
	To Match Door	666.77
Double Executive Full Framing Kit (width 3001 mm to 4420 mm)	Black/White/Anthracite	684.96
	To Match Door	812.25
Large Double Executive Full Framing Kit (width 4420 mm +)	Black/White/Anthracite	751.63
	To Match Door	921.36
Basic Reveal Fixing Kits		
Brackets, Rivets, Nuts & Bolts	Loose	77.59

Windows

See page 27 for further window information.

PVC Frames	Glazing		
Rectangular	Polycarbonate	Clear or Granite	108
		Inset Design (surcharge)	12
	Double Glazing	Clear or Frosted	144

Lead time varies depending on size and panel configuration.

VISIO

NEW & EXCLUSIVE

Smooth panel only

**Premium Colours £65/m²
Ultimate Colours £81/m²
Any RAL £81/m²**

Floor To Underside Of Fascia (height)

Between Track Width: Min 1800 mm, Max 4000 mm | Height: Min 1800 mm, Max 2600 mm

	2134 mm / 7ft	2286 mm / 7ft 6in	2438 mm / 8ft	2591 mm / 8ft 6in	2743 mm / 9ft	3048 mm / 10ft	3250 mm / 12ft 6in	3353 mm / 11ft	3658 mm / 12ft	3962 mm / 13ft
1981 mm / 6ft 6in	2744	2786	2830	2860	2930	3034	3076	3091	3210	3279
2134 mm / 7ft	2770	2806	2855	2883	2957	3063	3108	3125	3242	3316
2235 mm / 7ft 4in	2820	2860	2909	2940	3044	3125	3168	3188	3309	3386
2438 mm / 8ft	2922	2950	2999	3039	3153	3245	3295	3315		
2600 mm / 8ft 6in	2922	2950	2999	3039	3153	3245	3295	3315		

Side Cover Profiles
40 mm & 100 mm (per side)

Black/White/Anthracite	To Match Door
53	68
57	74
59	77
65	83
67	87



Lintel Profile 60/90/100/130 mm

	2134 mm / 7ft	2286 mm / 7ft 6in	2438 mm / 8ft	2591 mm / 8ft 6in	2743 mm / 9ft	3048 mm / 10ft	3250 mm / 12ft 6in	3353 mm / 11ft	3658 mm / 12ft	3962 mm / 13ft
Black/White/Anthracite	70	79	89	100	110	128	144	157	178	204
To Match Door	128	144	162	180	202	236	263	284	327	371

Standard Colours (free of charge)



White



Anthracite



Anthracite Dura



Black Dura



Dark Grey Metallic Smooth 2100

Reveal Fitting Kits

Executive Framing Kits		
Single Executive Full Framing Kit (width up to 3000 mm)	Black/White/Anthracite	533.42
	To Match Door	666.77
Double Executive Full Framing Kit (width 3001 mm to 4420 mm)	Black/White/Anthracite	684.96
	To Match Door	812.25
Large Double Executive Full Framing Kit (width 4420 mm +)	Black/White/Anthracite	751.63
	To Match Door	921.36
Basic Reveal Fixing Kits		
Brackets, Rivets, Nuts & Bolts	Loose	77.59

Glazing

Available with Clear, Frosted or Smoked Glazing



Frosted Glazing

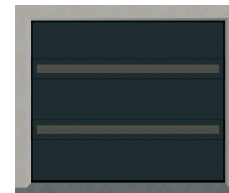

Smoked Glazing



Two-colour doors available for **£302** (surcharge)

SECTIONAL COLOURS & FINISHES

Standard & Premium Colours

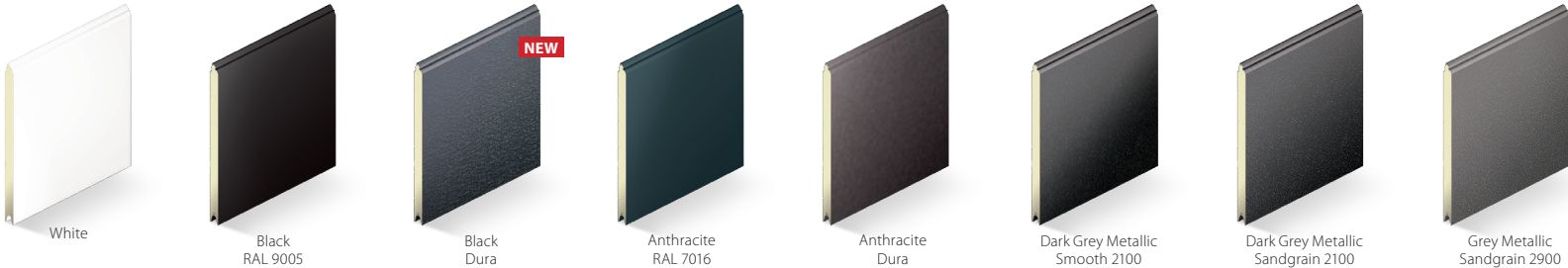

Ultimate Colours

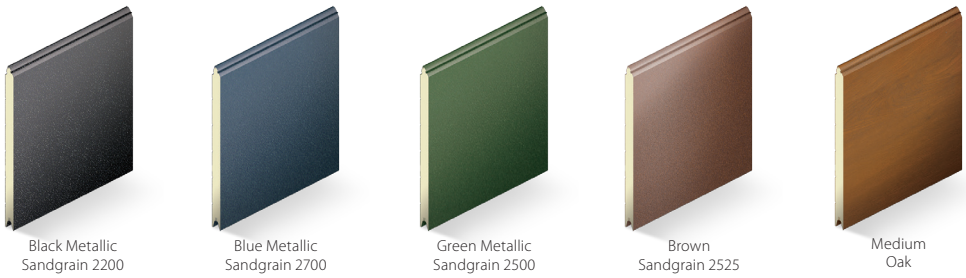

White Hinges

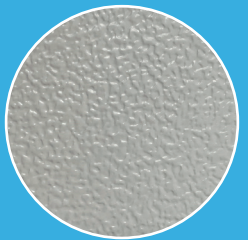

Stucco Interior

DON'T FORGET!
We can match your existing doors or windows!

AVAILABLE IN ANY RAL
£81 per square metre

PANEL PRICING

Standard Colours



Premium & Ultimate Colours



		Standard Colours * Premium Colours **											Ultimate Colours ***					
Panel	Finish	White	Anthracite	Black	Silver Metallic	Dark Grey Metallic	Grey Metallic	Light Grey Metallic	Light Grey	Light Ivory	Burgundy	Brown	Brown Metallic	Black Metallic	Blue Metallic	Green Metallic	Medium Oak	Any RAL
Un-Ribbed	Smooth	•	•	•		•			••	••	••	••						•••
	Woodgrain	•	•	••					••	••	••	••					•••	•••
	Sandgrain		•	•	••	••	••	••					•••	•••	•••	•••		
Centre Ribbed	Smooth	•	••	••					••	••	••	••						•••
	Woodgrain	•	••	••					••	••	••	••					•••	•••
	Sandgrain		•		••	••	••	••					•••	•••	•••	•••		
Ribbed	Woodgrain	•	•	••	•				••	••	••	••					•••	•••
Top Ribbed	Smooth	•	••	••					••	••	••	••						•••
	Sandgrain		•		••	••	••	••					•••	•••	•••	•••		
Micro-Rib	Smooth	•	••	••	•				••	••	••	••						•••
	Sandgrain				••	••	••	••					•••	•••	•••	•••		
Visio	Smooth	•	•	••		•			••	••	••	••						•••
	Sandgrain		•	•	••	••	••	••					•••	•••	•••	•••		
Georgian Cassette	Woodgrain	•	••	••					••	••	••	••						•••

Premium Colours £65/m²
Ultimate Colours £81/m²

BRUSHED ALUMINIUM DECALS **NEW**

PREMIUM DECALS - £304

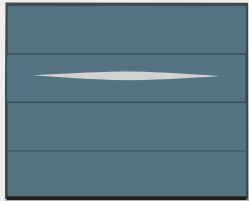

Ellipse

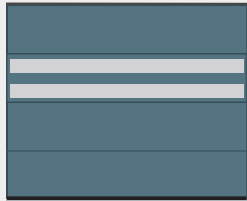

Duo



Finesse



Flower

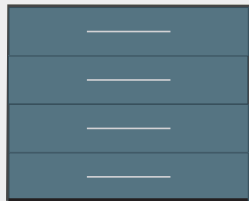

Line

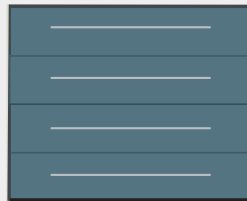

Line Large

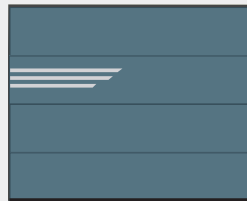

Lineo

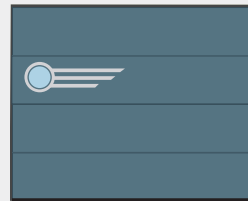

Lineo
(with Round Window)

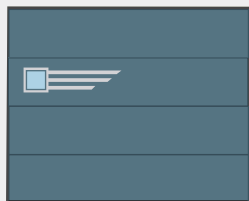

Lineo
(with Square Window)

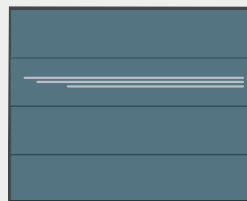

Lineo Large

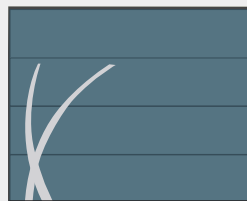

Stems

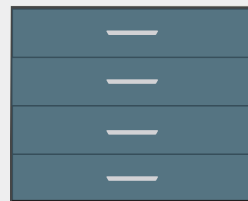

Trapezium

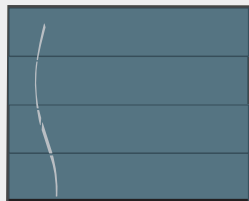

Wave

Add Windows to the Lineo Decal

Window	Glazing		
	Double Glazing	Clear	Frosted
Round (280mm)	Clear	326	
	Frosted	347	
Square (280 x 280mm)	Clear	280	
	Frosted	304	

ULTIMATE DECALS - £529

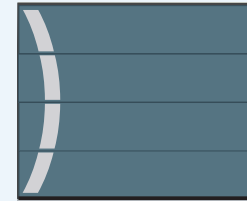

Curve

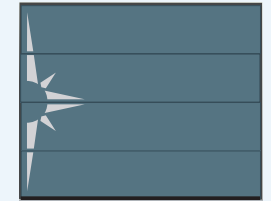

Sunbeam



Sunrise



NEW Anthracite Smooth with Duo



NEW Anthracite Smooth with Lineo

SECTIONAL ACCESSORIES

Windows

PVC colour matched to the door	Glazing		
Rectangular (511 x 321mm)	Polycarbonate	Clear or Granite Pattern	108
		Inset Design (surcharge)	12
	Double Glazing	Clear or Frosted	144
Round (315mm)	Polycarbonate	Clear or Textured	96
Brushed Aluminium Frames	Glazing		
Round (280mm)	Double Glazing	Clear	326
		Frosted	347
Square (280 x 280mm)	Double Glazing	Clear	280
		Frosted	304
Line (1860 x 180mm) NEW	Triple Glazing	Frosted	783

Lifestyle Accessories **NEW**

Ventilation Grill	each	53
Letter Box	each	194
Cat Flap	each	141



Letter Box



Cat Flap



Ventilation Grill



White Woodgrain Ribbed with PVC Windows



Black Smooth with Pedestrian Door & Square Windows

Optional Extras

Tandem Rollers	per door	-	Free Upgrade
Lockable Manual Override (loose)	each	SG305L0	45.00
Slide Bolt	each	SG125P0	26.84
Security Kit	each	SG060S0	84.00
Spring Covers (2400mm)	pair	SG897C2	62.00
Additional Track Hangers (408mm)	each	SG059P3	13.00
Track Hanger Extension Bars	each	SG059P4	12.00
Structural Fixing Kit	per kit	SG301F0	9.50
Horizontal Motor Bracket	each	SG896B0	33.34
Rail Adjustment Kit	each	SG059P5	108.00
SeceuroSeal	per metre	BS810B0	27.90
SeceuroSeal Adhesive (290ml)	each	BS810B1	18.16



Spring Covers



Security Kit

Standard window positions are horizontal, across the top or vertical down either the left or right size

Available for £1702 (surcharge)
Standard Panels only



NEW Anthracite Ribbed with Wicket Door

Options

Size (w)	790mm
	900mm
Threshold	60mm (standard)
	35mm (low-trip)

Wicket Door position

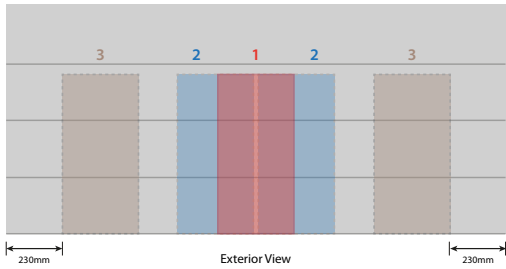

- 1 - Centre
- 2 - Centre Right / Centre Left
- 3 - Left or Right side

Concealed door closure with integrated locking

Safety switch isolates the motor when the wicket door is open

Powder coated galvanised steel hinges

Secure multi-point locking

High-end brushed aluminium handle

Concealed split side hinges

Optional low-trip 35mm threshold

Note: Wicket doors are compatible with Somfy motor operators and manual operation doors only.

SECTIONAL OPERATORS

BLACK EDITION



The 800Nm Black Edition motor operator by NRG is compatible with a variety of hand transmitters, wall switches and keypads, offering great value, choice and control.



Features:

- For doors up to 2800 mm high
- Simple programming and force setting
- Obstacle detection
- Soft start and stop
- Hidden program buttons
- Integrated LED light

STOCK CODE	DESCRIPTION	PRICE (£)
YSG840B1	Black Edition 800 Operator & one-piece 3000 mm Belt Rail (With 2 Chrome Deluxe Handsets)	357.37
YSG840B2	Black Edition 800 Operator & one-piece 3300 mm Belt Rail (With 2 Chrome Deluxe Handsets)	374.67
YSG840B3	Black Edition 800 Operator & one-piece 3600 mm Boom/Belt Rail (With 2 Chrome Deluxe Handsets)	420.78

See page 31 for the full range of compatible handsets, wireless wall switches and key switches.



NEW



Backed by SeceuroGlide's **EXCLUSIVE 7-YEAR WARRANTY**, the Dexxo range of motor operators from Somfy, the European leader in motor and control solutions, are easy to install, program and modify. Fully compatible with Somfy's extensive range of Home Automation accessories, including security cameras and motion sensors.

Dexxo Compact



Dexxo Optimo 800



Dexxo Pro 1000



Feature	Compact 600	Optimo 800	Pro 1000
Door Size	Up to 7 m ²	Up to 10 m ²	Up to 15 m ²
Speed	Up to 14 cm/s	Up to 14 cm/s	Up to 18 cm/s
Functions	2	4	Up to 17
Obstacle Detection	✓	✓	✓
Soft Start and Stop	✓	✓	✓
Pre-Programmed Settings	✓	✓	✓
Lock Programming	✗	✓	✓
Integrated LED Light	✓	✓	✓
Smart Home Compatible	✓	✓	✓

YEC600C2	Dexxo Compact Operator & 2900 mm one-piece Belt Rail (With 2 Keytis 2 Channel Transmitters)	403.49
YEC600C3	Dexxo Compact Operator & 3500 mm one-piece Belt Rail (With 2 Keytis 2 Channel Transmitters)	415.01
YEC800C2	Dexxo Optimo 800 RTS Operator & 2900 mm one-piece Belt Rail (With 2 Keytis 2 Channel Transmitters)	409.25
YEC800C3	Dexxo Optimo 800 RTS Operator & 3500 one-piece Belt Rail (With 2 Keytis 2 Channel Transmitters)	420.78
YEC100D2	Dexxo Pro 1000 RTS Operator & 2900 mm one-piece Belt Rail (With 2 Keygo 4 Channel Transmitters)	530.30
YEC100D3	Dexxo Pro 1000 RTS Operator & 3500 mm one-piece Belt Rail (With 2 Keygo 4 Channel Transmitters)	541.83

See page 32 for the full range of additional Somfy accessories.

CALCULATING SIZE AND PRICE - SECTIONAL

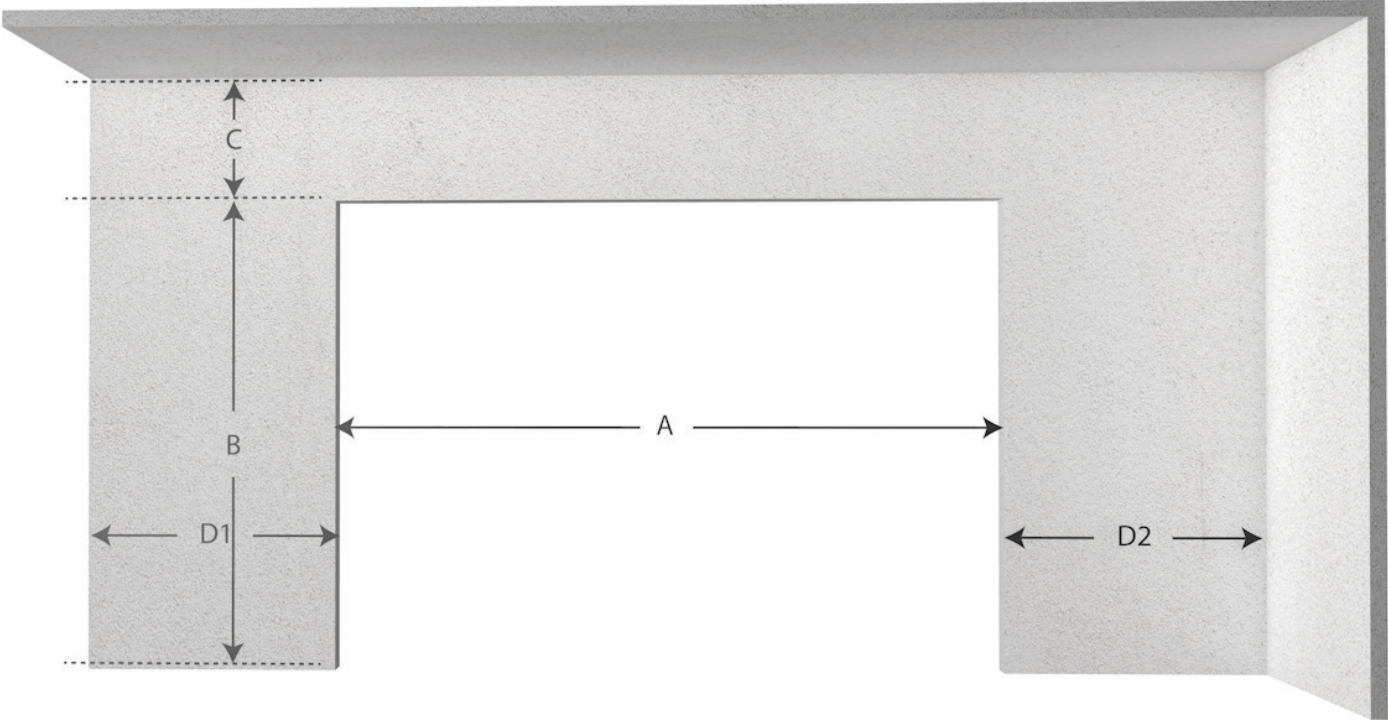

Dimensions and Headrooms

Types	Minimum Side Room Required (D1 & D2)	Actual Drive-Through Height (electric)		Minimum Headroom Required	
		Manual	Electric	Manual (C)	Electric (C)
Elite	85 mm	DOH – 230 mm	DOH – 20 mm	100 mm	130 mm

DOW Daylight Opening Width (**A on illustration**)

DOH Daylight Opening Height (**B on illustration**)

Executive frame kit has a 100 mm frame leg each side.

Executive frame kit has 100 mm wide head frame.

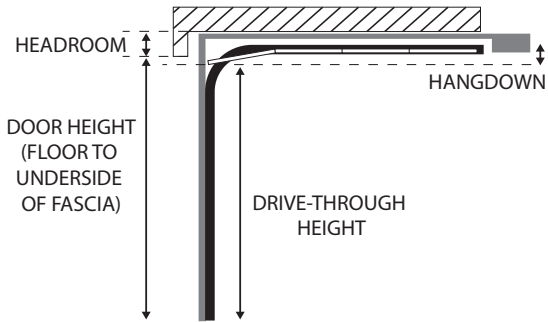

SECEUROSENSE / BLACK EDITION OPERATOR OPTIONS & ACCESSORIES

IMAGE	DESCRIPTION	PROFILE	STOCK CODE	PRICE (£)
SPARES AND UPGRADES				
	SeceuroSense Plus Receiver Unit – Wireless	each	EC89100	250.39
	SeceuroSense Plus Receiver Unit – Wired	each	EC89200	250.39
	SeceuroSense Plus Receiver Unit – Wireless IP/External BST	each	EC89300	250.39
	SeceuroSense Bottom Slat Transmitter 1.5v	each	EC75100	158.41
	SeceuroSense Bottom Slat Transmitter for Built-In Alarm (BST25) 1.5v	each	EC75200	169.79
	Radio Card & BST Upgrade Kit	each	EC99000	332.94
	Upgrade to SeceuroSense External Bottom Slat Transmitter	each	YSGACCS1 EXTERNAL	170.67
	Replacement Light Bulb for SeceuroSense Courtesy Light	each	EC72500	5.81
	Batteries for SeceuroSense Transmitters (CR2032)	each	EC36101	7.27
	Duracell Batteries for SeceuroSense Bottom Slat Transmitter 1.5v	each	EC75101	2.61
	3.6v Lithium Battery For SeceuroSense (2pk)	each	EC71101	37.79
	Radio Card for 3.6v BST	each	EC79900	169.78
	Radio Card for 3.6/1.5v BST	each	EC79800	169.78
	Radio Card for 1.5v BST25	each	EC79802	169.78
	Alarm Kit for SeceuroSense Plus	each	EC72300	113.37
	SeceuroSense Hard Wired Magnets (for uneven floors)	each	EC72600	68.30
	SeceuroSense Photocell & Reflector	each	EC70500	124.65

SeceuroSense

IMAGE	DESCRIPTION	PROFILE	STOCK CODE	PRICE (£)
SECEUROSENSE HAND TRANSMITTERS				
	Chrome Deluxe 2 channel transmitter	each	EC71602	112.94
	Chrome Deluxe 4 channel transmitter	each	EC71604	112.94
	Smooth black 2 channel transmitter	each	EC71202	98.83
	Smooth black 4 channel transmitter	each	EC71204	98.83
	Smooth black 4 channel bi-directional transmitter	each	EC75104	119.17
	Smooth white 2 channel transmitter	each	EC71102	98.83
	Smooth white 4 channel transmitter	each	EC71104	98.83
	Smooth white 4 channel bi-directional transmitter	each	EC75004	119.17
	S/Sense Black Deluxe 2 channel transmitter	each	EC71702	98.83
	S/Sense Black Deluxe 4 channel transmitter	each	EC71704	98.83
	Plus 3 channel transmitter	each	EC71303	98.83
SECEUROSENSE WALL SWITCHES AND BIDIRECTIONAL CONTROLS				
	4 channel black wall transmitter	each	EC73104	126.44
	4 channel black bi-directional wall switch	each	EC74104	181.67
	4 channel white wall transmitter	each	EC73004	126.44
	4 channel white bi-directional wall switch	each	EC74004	181.67
	4 channel stainless steel cover for wall transmitter	each	EC73000	52.32
	Wireless keypad	each	EC70300	302.30
SECEUROSENSE LIGHTING				
	Lighting strip external 1000 mm with transformer	each	EC76000	325.56
	One light per operator	each	-	194.33
	Lighting Strip External 2 x 1000 mm	each	EC77000	427.30
	Lighting Aluminium Cover 2000 mm	each	EC78000	120.63
	Moon Lights Kit. 2 Lights with Transformer	each	EC79000	165.03

SeceuroSense + Black Edition

SOMFY OPTIONS & ACCESSORIES



IMAGE	DESCRIPTION	PROFILE	STOCK CODE	PRICE (£)		
SPARES AND UPGRADES						
	Rollixo Premium Receiver & 2 Keygo Transmitters	RTS	EC46000	447.08	Rollixo	
		IO	EC46002	478.95		
	Rollixo XSE Bottom Slat Transmitter	each	BS680B0	155.37		
	Rollixo alarm kit	each	EC41001	28.52		
	Rollixo magnet	each	BS680M0	33.48		
	Replacement Bulb for Somfy Rollixo Receiver	each	EC000B1	31.04		
	Battery Back-up Pack (5-10 operating cycles in 24 hours)	each	SG098P0	55.23		Dexxo
	Replacement Bulb for Somfy Dexxo Operator	each	EC001B0	29.50		
	Smooove Origin Wireless Wall Switch	RTS	EC37700	71.28		Rollixo + Dexxo
		IO	EC37702			
	Smooove Origin 4 Wireless Wall Switch	RTS	EC37704	125.87		
		IO	EC37703			
	Keygo 4-Channel Transmitters	RTS	SG100P0	98.65		
		IO	SG100P1			
	Keytis 2-Channel Transmitters RTS	each	EC101350	72.10		
	Situlo 1 RTS Pure II Situlo 1 RTS Iron II Situlo 1 RTS Natural II Situlo 1 RTS Artic II	each	EC37800	68.36		
			EC37801	133.57		
			EC37802	139.44		
			EC37803	139.44		
	Situlo 5 RTS Pure II Situlo 5 RTS Iron II Situlo 5 RTS Natural II Situlo 5 RTS Artic II	each	EC37900	99.45		
			EC37901	134.14		
			EC37902	178.90		
			EC37903	178.90		
	Somfy RTS Standard Receiver	each	SG103P0	161.39		
	Batteries for Keygo Transmitter	each	EC36100	7.17		
	Wireless Keypad 2	RTS	SG101P1	195.00		
		IO	SG101P2			
	Wireless Wall Mounted Switch RTS	each	SG099P0	49.95		
	Wireless Wallswitch 3	RTS	SG099P1	86.46		
		IO	SG099P3			

IMAGE	DESCRIPTION	PROFILE	STOCK CODE	PRICE (£)	
SPARES AND UPGRADES					
	TaHoma Switch	each	EC462TS	362.98	Rollixo + Dexxo
	Somfy Connectivity Kit	each	EC460CK	119.35	
	Indoor Camera	each	EC470IC	374.41	
	Smoke Detector	each	EC481SM	169.74	
	Temperature Sensor	each	EC482TS	225.48	
	Outdoor Camera (White)	each	EC471CW	600.00	
	Outdoor Camera (Anthracite)	each	EC472CA	600.00	

A Smart Way of Living

With easy installation and programming, smart controls from Somfy enables you to operate your garage door, motorised blinds, gates, awnings and lights at anytime, from anywhere, all in one place.



Somfy: TaHoma Switch

EASY HOME AUTOMATION

- Easy plug in and go set-up
- Can be installed anywhere in your home thanks to WiFi connectivity
- Customise each button to create your own personalised scenarios
- Operate everything from one place with the Somfy app
- Convenient voice control for on-the-go operation
- Compatible with over 300 products including Amazon Alexa, Google Home, Sonos, Hive, IFTTT and many more

NEW CONNECTIVITY KIT

The new Connectivity Kit from Somfy is a great value home automation hub. With more basic functions, it is ideal for homeowners looking for smart-home connectivity without the need for some of the advanced features available with the TaHoma switch.



Somfy: Connectivity Kit

Feature	TaHoma Switch	Connectivity Kit
TaHoma App	✓	✓
Voice Assistant	✓	✓
Individual & Group Control	✓	✓
Manual Scenes	40	20
Scheduled Scenes	20	
Advanced Scenes (Smart)	20	
Capacity	> 200 Devices	20 Devices

IMPORTANT INFORMATION

SAFETY & COMPLIANCE

- The SeceuroGlide range is fully compliant with the latest UK product directives and standards including BS EN 13241-1 applicable from the 1st May 2005.
- To ensure compliance with the Construction Products Regulation SeceuroGlide Compact must be installed with either a SeceuroSense Plus / Rollixo remote control or a 'hold-to-run' switch or key switch.
- Antidrop devices are supplied when required at no extra cost.
- We recommend the use of photocells in addition to the standard bottom slat sensor in garages where a vehicle will be parked close to the door. Where a door opens directly onto a pavement or in a public area, a combination of bottom slat sensor and photocells is a statutory requirement.
- When operating a garage door with Somfy home automation equipment, the door must be fitted with photocells. If ordering photocells retrospectively, the panel will need to be checked for compatibility. For more information please contact our Technical Support line on 01524 772 400.
- When a SeceuroGlide Sectional door is supplied motor ready, the installer is required to carry out force testing and is responsible for ensuring the results are within the permitted force.

COLOURS & FINISHES

- The printing process does not allow exact reproduction of the paint colours. If you are unsure of your colour choice please ask your supplier for a sample. Colour references quoted are the nearest standard RAL or BS number to the colours used. They will not be an exact match and are intended as a guide only.
- Doors are supplied with frames, guides, fascias, boxes, bottom slats, locking slats, vision slats and ventilation slats in either a solid powder coated painted finish or a wood effect finish in the best colour to match the door. Due to the manufacturing process, it may not be possible to obtain an exact match and the texture of the finish may vary.
- Multiple doors should be ordered together to obtain the best colour match, bearing in mind the limitations of the materials used in construction.
- Powder coated curtains in a custom colour are available on the SeceuroGlide Original and Excel up to 4500mm wide only.
- Custom colour garage doors are finished in a low gloss finish which is similar in gloss level to the pre-coated colours. Where the curtain is powder coated a custom colour, the guide rails, bottom slats, optional fascias, vision panels and end plates will be powder coated to match FOC. Some custom powder coated colours may be subject to an additional surcharge.
- Due to the powder coating process, an un-painted area of each slat is visible on the quirk when the door is opening/closing. This should not be visible when the door is in the closed position. To mitigate this, we recommend purchasing powder coated doors with a full box or 45° box cover.
- When Painted Woodgrains are supplied with a colour matched box, end plates and guides, the following RAL are used: Golden Oak RAL 8003, Irish Oak RAL 1011, Rosewood RAL 8017.
- Foiled Woodgrains are subject to a surcharge. Additional Renolit woodgrain finishes are available at the same cost as the standard Foiled Woodgrain colours, however longer lead times may apply.
- SeceuroGlide Compact textured woodgrain doors are supplied with matching bottom slats and brown inner face, guides, end plates and half box as standard.

- For woodgrain effect doors, any vision/vented slats will be supplied in a solid colour nearest to the colour of the woodgrain. Vision slats are NOT available on the Compact or the Manual.
- The visual panel configuration on sectional doors varies depending on the height and/or width of the door. The appearance of different sized doors made from the same panel can vary significantly.
- The nature of roller garage doors means marking may appear on the internal side of the slats over time. Occasionally some marking may occur at the top of the concave (coil) side of the curtain over time, particularly on the Compact and LT. This is unavoidable and due to prolonged contact with the locking system. On doors which are installed externally this will be visible on the outside.
- The factory application of the paint finish involves an automated process and this may result in minor blemishes or slight inconsistencies in the paint.
- We recommend that you perform a visual quality check on installation. Carry out the quality check in natural daylight, not direct sunlight. Stand at a distance of 3 metres from the product to view the overall appearance.
- The product is acceptable if, taking into account the facts below, none of the following is readily visible on the face of the product:
 - Marks or distortions associated with the manufacturing process
 - Minor indentations, marks or scuffs on the surface
 - Paint or stain blemishes
- While weathering and sun exposure can cause the exterior surface to fade, colour change or fade will be limited and uniform.

PRODUCT CARE

- Correct operation and care of your SeceuroGlide door in accordance with the official Operating & Maintenance Manual will prolong the life of your door and minimise the likelihood of issues.
- The door needs wiping with a damp cloth and a mild detergent to remove any excessive dirt/grime to maintain its appearance and to reduce the risk of the surface being damaged.
- The floor must be smooth, level and kept clear of dirt and debris, which can cause deterioration of the rubber seal.

EXTREME WEATHER CONDITIONS

- High winds and high temperatures can cause increased deflection of the door. It is the installer's responsibility to ensure that the door is spaced off the wall sufficiently to allow for door movement during these extreme weather conditions.
- Darker coloured double doors that are exposed to significant direct sunlight may be susceptible to expansion which may interfere with the operation of the door.
- If a door is situated in an exposed location and subjected to very high winds and driving rain, SeceuroGlide does not guarantee against water ingress. As part of the product's testing for the CE or UKCA marking, the product has not been tested against this and as such is classified as NPD (No Performance Declared).
- Whilst the garage door profiles and panels are primed and coated for the external environment – any doors fitted in coastal environments may be at risk of deterioration due to the weather conditions. Ensure you keep your door clean and follow the instructions for cleaning the door in the Operating & Maintenance Manual.

- Regular cleaning of products in 'high corrosive areas' such as within 2 miles of the sea is especially important. Your door should be cleaned thoroughly weekly using warm water and mild detergent with a soft cloth or sponge. Allow to dry naturally. Never use strong detergent, abrasive, caustic or solvent-based cleaners.
- In the event of extreme weather conditions, vision slats will be susceptible to water ingress and may cause the door to move in extreme gales.
- SeceuroGlide Original and Excel doors tested to a minimum Class 2 wind resistance classification, which is equivalent to 59mph winds (Force 10 Storm).
- SeceuroGlide Sectional Doors tested to a Class 5 wind resistance classification, which is equivalent to 114mph winds (Force 14 Storm).

FITTING

- SeceuroGlide Excel must always be fitted internal face fitted or reveal fitted.
- When fitted externally SeceuroGlide Original and SeceuroGlide Compact will always be supplied with a full box.
- SeceuroGlide Manual can only be fitted internally.
- A low level override option is not available for SeceuroGlide Excel. Where the garage door is the only means of exit from a garage, a low level override can be supplied, however this will affect the Level 1 certification and SBD certification will not be supplied.
- If vented slats are selected as an option on SeceuroGlide Original or Excel, they will be supplied, however, this will affect the Level 1 and SBD accreditation and the security certification will not be supplied.
- Unless requested otherwise, when installed internally, tubular motors will be fitted on the left-hand side of each door (when viewed from inside the garage looking out). Alternatively, unless requested otherwise, when installed externally, tubular motors will be fitted on the left-hand side of each door (when viewed from outside the garage looking in).

WARRANTIES

Peace-of-Mind Warranties

- The SeceuroGlide warranty covers parts only and does not cover labour costs or consequential costs, including but not limited to call-out fees, transport costs and costs remedial work for removing and/or re-installing faulty parts.
- SWS UK will replace or repair any components of our products where the manufacturing process has resulted in a defect occurring during the relevant period, subject to the exceptions and conditions set out below.
- For all replacement electrical parts, the warranty period is 12 months or the remainder of the warranty period (whichever is the longest).

The warranty does not cover the following:

- ✗ Any marks, distortion, stains, blemishes, indentations or scuffs which are not observable from at least 3 metres away in natural light (not direct sunlight).
- ✗ Defects which are as a result of:
 - Incorrect installation of the product, not following SWS UK's installation instructions.
 - Incorrect or lack of proper care and maintenance of the product in accordance with SWS UK's Operating & Maintenance Manual.
 - Incorrect operation of the product.
 - Any modifications made to the product made by anyone other than SWS UK.
 - Normal wear and tear.
 - Accidental or malicious damage.
 - Impact damage or scratches, dents, scuffs or other minor abrasions.
 - Use or attempted use of non-SWS UK spare parts.
 - Repairs or attempts at repairs undertaken by any person other than someone specifically authorised by SWS UK.
 - Any failure of masonry or other structures on to which the product has been fixed.
 - Any attempt to reduce operating clearances by means of infills or draughtproofing.
 - External influences such as extreme or abnormal weather conditions, fire, water, salts, chemicals and bird droppings.
 - Any fault or surge in the customer's electricity.
- ✗ Rust or corrosion caused by exposure to saltwater or salty air for products installed within **500 metres of the sea** or a large body of saltwater. For products installed within 2 miles of the sea, the exterior finish of the product is guaranteed for a limited period of 2 years.
- ✗ Consumables such as fuses, light bulbs or batteries.
- ✗ Indirect, special or consequential loss or damage howsoever caused, including remedial work costs, call-out fees, tool or plant hire and transport costs.

Warranties

SeceuroGlide Garage Doors are guaranteed against defect of material or workmanship by SWS UK with a parts only warranty, subject to correct installation, maintenance and operation:

Roller Garage Doors

- **Curtain finish:**
 - Standard Colours – 5 years
 - Painted Woodgrains – 5 years
 - Foiled Woodgrains – 10 years
- **Motor & control unit:**
5 years as standard, or 7 years when you purchase:
 - A SeceuroDrive motor with a SeceuroSense Plus control unit**OR**
 - A door with **EITHER** a Somfy motor or control unit.Subject to online warranty registration within 3 months of installation - excludes the LT.

Sectional Garage Doors

- **Panel finish:**
 - Un-painted panels – 10 years
 - Painted panels – 5 years
- **Black Edition motor operator** – 5 years
- **Somfy motor operators** – 7 years (subject to online warranty registration within 3 months of installation). 5-year warranty applies if the product is not registered.

All Doors

- **Mechanism & hardware** – 5 years
- **Perishable rubber parts** – 2 years



Register Your Warranty

You must register your warranty at www.seceuroglide.co.uk/warranty to activate your extended product guarantee. It takes just a few moments and also gives you easier access to maintenance and operation information, spare parts and warranty claims.

Regular Servicing

To ensure the longevity and continued good operation of your SeceuroGlide Garage Door, it is recommended that your door is serviced by a trained engineer every 12 months. You may be required to show a full service record for the product when raising a warranty claim.

DELIVERY, PACKING & WARRANTIES

Delivery Charges	Price (£)
Over £500 net on standard run	Nil
Under £500 net on standard run	52.45
All orders required on a different day to standard delivery run	POA
Collection from distribution depot	Nil
Pre agreed time slot for standard deliveries	POA
Site delivery charge one man offload	76.79 extra
Site delivery charge two man offload	125.99 extra
Redelivery of goods	48.13 extra
Deliveries to Scotland	45.96 per drop
Deliveries to Ireland	POA

All packaged items above 6.8 m will incur an additional charge and will be subject to quotation.

Carrier Services	Price (£)
Component items up to 5 kg	14.99
Component items up to 20 kg	59.49
Delivery & packaging of fragile items over 20 kg	106.99
Pre 10.30 am	53.49 extra
Pre noon	29.99 extra
Saturday pre noon	59.99 extra
Additional surcharges apply on the following:	
Channel Islands & Scottish offshore	131.49
Highlands	43.99
Grampian	39.99
Isle of Man	139.99
Isle of Wight	26.49
Devon & Cornwall	14.99
Central London	14.99

Delivery Service

Our standard delivery service covers England and Wales weekly and Scotland fortnightly. Our pricing includes delivery on all orders over £500 on our standard weekly service. Additional chargeable deliveries can often be arranged with your internal account manager. We also offer home/site delivery service options with one or two men depending on the size of delivery and site conditions. Delivery confirmations for our own dedicated service will be emailed or texted the previous afternoon to confirm if AM or PM the following working day. Please ensure an email address and/or mobile number is supplied on your order.

IMPORTANT DELIVERY NOTES: Site deliveries will only be made if the installer is in attendance to assist off loading or if extra help with off loading has been arranged. The most cost effective and safest way of delivering orders is via our own transport

For urgent orders in certain areas of the country, collection is possible from our 3 distribution depots (must be collected within 24 hours):

South (Heathrow)

Units 2, 3 & 4, Lakeside Industrial Estate, Lakeside Road, Colnbrook SL3 0ED

Midlands (Willenhall)

DX Freight, Unit 1 Bays 1, 2, 3 East Acre, Off Long Acre, Willenhall WV13 2JZ

Bristol

Jupiter Road, Patchway, Bristol BS34 5BW

COMPONENT ORDERS

All small component orders required next day must be received by 2 pm the day before delivery. Orders placed on a Friday must be received by 12 noon for delivery on Monday.

If you require powder-coated items, please allow an additional 24 hours at least from the receipt of order. Items for assembly need to be booked in for manufacturing – for example complete shutter curtains. Please allow a minimum of three working days depending on the delivery method.

Regrettably it is not possible to send items over 5 m in length by overnight carriers.

CRATE CHARGES

We can offer delivery by crate on a POA basis. Please speak to Customer Services.

SWS UK is proud to be an official supporting supplier of the Door Hardware Federation. In line with SWS UK's policy of continuous product development, we reserve the right to make changes without prior notification. All information is believed correct at the time of publication, errors and omissions excepted.

DELIVERY CHECK-LIST

A. Pre-delivery

- A postcode must be supplied for all delivery addresses.
- We currently operate a range of delivery vehicles. It is therefore important to check the lorry's dimensions when arranging a delivery for the first time.
- If you require a delivery to site you must supply us with a contact name and a contact telephone number of the person who will assist the driver to unload.

B. Receipt of goods – own premises

- We require a person to assist off-load, check and sign for goods.
- For large deliveries, please ensure you have several people to assist, this will minimise any delays for subsequent customers.
- Deliveries received must be checked before signing the delivery note. It is not possible to claim compensation for damaged or missing items unless highlighted on the drivers delivery notes. If possible take a copy of this documentation for future reference.

C. Receipt of goods – to site

- Deliveries will only be made to site if an installer is present to assist the driver with unloading and to check and sign for the goods.

- For large deliveries, please ensure you have several people to assist, this will minimise any delays for subsequent customers.
- Before the goods arrive, please prepare a location to unload and store the items safely and securely.
- Deliveries received by overnight carrier must be checked before signing the delivery note. It is not possible to claim compensation for damaged or missing items unless highlighted on the drivers delivery notes. If possible take a copy of this documentation for future reference



D. Claims for damages

- Please check the contents of your order against the delivery note on the day received. Care should be taken when using sharp objects to cut through the packaging.
- Claims for missing or damaged items will only be processed if the drivers delivery note has been signed for as damaged or missing and must be reported within 2 days of delivery.

IF YOU SUSPECT DAMAGE Please fully inspect the product prior to signing. If the product is damaged, clearly state "DAMAGED" when signing the consignment note. Signing as "Unchecked" is insufficient.



A StellaGroup Company

Raising Standards
Safety Assured

Visit www.seceuroglide.co.uk