

The Garador Range Price List

1st October 2015 Garage Doors, Front Entrance Doors and Automatic Operators



General Information

All prices are quoted in £ Sterling, ex-works and exclusive of VAT.

Please ensure that you order the correct size door to fit your opening as we are unable to accept the return of incorrectly ordered goods. Please contact Garador on 01935 443722 if you need assistance in calculating the correct size.

A comprehensive range of the less common accessories and all spare parts are available either online or ask for a current spares price list if required.

Since the company's policy is one of continuous improvement of its products, we reserve the right to make any alterations in design, manufacture or price.

All business is governed by the Company's Standard Conditions and this document does not form any part of any contract with the company and statements contained in it should not be construed as representations or warranties.

For more information please visit
www.garador.co.uk



Contents

Steel Panel Doors	4
Guardian Range	16
Design Range	18
PVC Panel Doors	20
GRP Premier Panel Doors	22
Timber Panel Doors	30
Steel and Timber Garage Side Doors	40
Steel and Timber Side-hinged Doors	44
Steel Panel Doors - Specifications	50
Steel Sectional Garage Doors	54
Automation and Accessories	64
GaraRoll Roller Doors	70
FrontGuard Entrance Doors	74
User Information / Care	82
Warranty	84
Extracts from DHF consumer advice	86

Steel Panel Doors

Surface

High quality powder or foil coated finish.

Please note: panel doors are produced with appearance in mind. This may result in some small gaps which could allow water ingress especially in exposed locations.

Colours

White (RAL 9016) and Terra Brown (RAL 8028) as standard, other optional colours of Moss Green (RAL 6005), Ruby Red (RAL 3003), Signal Blue (RAL 5005), Jet Black (RAL 9005), Steel Blue (RAL 5011), Light Ivory (RAL 1015), Pigeon Blue (RAL 5014), Fir Green (RAL 6009), Anthracite Grey (RAL 7016), Stone Grey (RAL 7030), Light Grey (RAL 7035), Ochre Brown (RAL 8001), Clay Brown (RAL 8003), White Aluminium (RAL 9006), Grey Aluminium (RAL 9007), Window Grey (RAL 7040) and Titan Metallic (CH 703)¹ are available on an approximate 4 week lead-time. The Wentwood, Sherwood, Georgian, Beaumont and Cathedral doors are available in Golden Oak and Rosewood foil coated timber effect with a solid chassis colour - and frame where applicable to match. These doors are also on an approximate 4 week lead-time.
¹Only available on Design Range doors.

Handle

Black handle as standard, optional handles are available (this option is not available on Wentwood or Sherwood single doors). Doors can be supplied undrilled and without handle and locking mechanism for use with electric operator (not available on Wentwood or Sherwood doors). This option makes the door purpose made and will therefore increase lead-time, please specify clearly on order.

Packaging

White, brown and timber effect doors are supplied unwrapped as standard with optional poly-wrapping available. Coloured doors are supplied wrapped and - also - include a touch up stick as standard. Side-hinged doors are provided wrapped as standard.

Stock availability

Prices in bold show stock doors on a standard lead-time (approx 1 week) in white unless specified. All other prices relate to non-stock doors on an approximately two to four week lead-time. Brown (RAL 8028 only) finished doors available ex-stock in 7066 and 7070 in Horizon, Carlton, Georgian, Beaumont and Cathedral. All other sizes in brown are non stock doors.

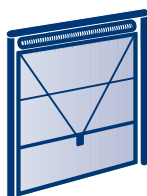

Canopy gearing

Canopy Gearing is available for all single doors providing a reliable and affordable gearing solution, with no tracks running back into the garage.

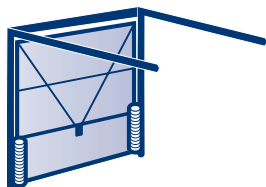

Retractable Gearing

Retractable Gearing is available for all single and double doors providing a reliable and affordable gearing solution, with tracks running back into the garage.

Single door

Size Code	Internal Timber frame opening Width x Height (mm x mm)	Horizon		Carlton		Ascot		Windsor	
		C	R	C	R	C	R	C	R
6660	1984 x 1830	505	546	574	615	-	-	-	-
6663	1984 x 1905	505	546	574	615	-	-	-	-
6664	1984 x 1931	505	546	574	615	-	-	-	-
6666	1984 x 1981	479	520	546	587	-	-	-	-
6670	1984 x 2136	479	520	546	587	-	-	-	-
61064	2084 x 1931	489	530	545	586	-	-	-	-
61066	2084 x 1981	500	541	545	586	-	-	-	-
61070	2084 x 2136	518	559	556	597	-	-	-	-
7060	2134 x 1830	519	560	589	630	-	-	-	-
7063	2134 x 1905	519	560	589	630	-	-	-	-
7064	2134 x 1931	494	535	548	589	-	-	-	-
7066	2134 x 1981	458	499	530	571	558	599	653	694
7070	2134 x 2136	501	542	552	593	623	664	674	715
7076	2134 x 2286	-	640	-	685	-	-	-	-
7164	2170 x 1931	494	535	548	589	-	-	-	-
7166	2170 x 1981	458	499	530	571	558	599	653	694
7170	2170 x 2136	501	542	552	593	623	664	674	715
7176	2170 x 2286	-	709	-	745	-	-	-	-
7364	2224 x 1931	538	579	573	614	-	-	-	-
7366	2224 x 1981	541	582	576	617	-	-	-	-
7370	2224 x 2136	549	590	583	624	-	-	-	-
7564	2259 x 1931	534	575	579	620	-	-	-	-
7566	2259 x 1981	538	579	579	620	641	682	699	740
7570	2259 x 2136	613	654	652	693	727	768	757	798
7576	2259 x 2286	-	762	-	745	-	-	-	-
7664	2284 x 1931	538	579	595	636	-	-	-	-
7666	2284 x 1981	538	579	595	636	641	682	699	740
7670	2284 x 2136	614	655	652	693	717	758	757	798
7676	2284 x 2286	-	766	-	745	-	-	-	-
8064	2439 x 1931	621	662	705	746	-	-	-	-
8066	2439 x 1981	621	662	705	746	711	752	810	851
8070	2439 x 2136	634	675	728	769	737	778	834	875
8076	2439 x 2286	-	746	-	811	-	-	-	-
8666	2590 x 1981	-	718	-	808	-	-	-	-
8670	2590 x 2136	-	743	-	842	-	-	-	-
8676	2590 x 2286	-	820	-	915	-	-	-	-
9066	2744 x 1981	-	857	-	868	-	-	-	-
9070	2744 x 2136	-	902	-	915	-	-	-	-
9076	2744 x 2286	-	936	-	951	-	-	-	-
1066	3049 x 1981	-	1013	-	977	-	-	-	-
1070	3049 x 2136	-	1024	-	987	-	-	-	-

Prices in bold show stock doors on a one-week lead-time. All other prices are non-stock standard doors on a two to four week lead-time.

Stock doors also available in Jet Black (based on RAL 9005).

For further options please see page 15.

Single door

Size Internal Timber
Code frame opening
Width x Height
(mm x mm)

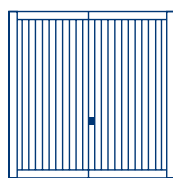

Sutton

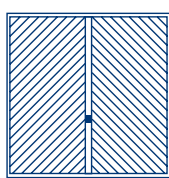

Chevron

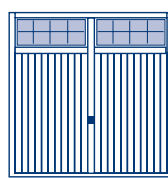
Salisbury ¹

Size Code	Internal Timber frame opening Width x Height (mm x mm)	Sutton		Chevron		Salisbury ¹	
		C	R	C	R	C	R
6660	1984 x 1830	-	-	-	-	-	-
6663	1984 x 1905	-	-	-	-	-	-
6664	1984 x 1931	-	-	-	-	-	-
6666	1984 x 1981	-	-	565	606	-	-
6670	1984 x 2136	-	-	565	606	-	-
61064	2084 x 1931	-	-	-	-	-	-
61066	2084 x 1981	-	-	-	-	-	-
61070	2084 x 2136	-	-	-	-	-	-
7060	2134 x 1830	-	-	-	-	-	-
7063	2134 x 1905	-	-	-	-	-	-
7064	2134 x 1931	599	640	599	640	913	954
7066	2134 x 1981	565	606	565	606	913	954
7070	2134 x 2136	604	645	604	645	923	964
7076	2134 x 2286	-	-	-	-	-	-
7164	2170 x 1931	-	-	-	-	-	-
7166	2170 x 1981	-	-	-	-	-	-
7170	2170 x 2136	-	-	-	-	-	-
7176	2170 x 2286	-	-	-	-	-	-
7364	2224 x 1931	-	-	-	-	-	-
7366	2224 x 1981	-	-	-	-	-	-
7370	2224 x 2136	-	-	-	-	-	-
7564	2259 x 1931	657	698	657	698	948	989
7566	2259 x 1981	657	698	657	698	948	989
7570	2259 x 2136	723	764	723	764	958	999
7576	2259 x 2286	-	-	-	-	-	-
7664	2284 x 1931	664	705	664	705	948	989
7666	2284 x 1981	630	671	630	671	948	989
7670	2284 x 2136	696	737	696	737	958	999
7676	2284 x 2286	-	-	-	-	-	-
8064	2439 x 1931	732	773	-	-	1006	1047
8066	2439 x 1981	732	773	-	-	1006	1047
8070	2439 x 2136	744	785	-	-	1016	1057
8076	2439 x 2286	-	-	-	-	-	-
8666	2590 x 1981	-	-	-	-	-	-
8670	2590 x 2136	-	-	-	-	-	-
8676	2590 x 2286	-	-	-	-	-	-
9066	2744 x 1981	-	-	-	-	-	-
9070	2744 x 2136	-	-	-	-	-	-
9076	2744 x 2286	-	-	-	-	-	-
1066	3049 x 1981	-	-	-	-	-	-
1070	3049 x 2136	-	-	-	-	-	-

¹ Salisbury windows (🪟) come as white or brown as standard, colour match windows are available to order as an option.

Prices in bold show stock doors on a one-week lead-time. All other prices are non-stock standard doors on a two to four week lead-time.

Please note that doors with windows may have cross bracing or locking rods passing behind the windows depending upon size and gear type.

Stock doors also available in Jet Black (based on RAL 9005).

For further options please see page 15.

Single door

Size Code	Internal Timber frame opening Width x Height (mm x mm)	Georgian		Beaumont		Cathedral		Beaumont with Windows ¹	
		C	R	C	R	C	R	C	R
6660	1984 x 1830	-	-	-	-	-	-	-	-
6663	1984 x 1905	-	-	-	-	-	-	-	-
6664	1984 x 1931	702	743	702	743	702	743	956	997
6666	1984 x 1981	665	706	665	706	665	706	960	1001
6670	1984 x 2136	675	716	675	716	675	716	930	971
61064	2084 x 1931	672	713	672	713	672	713	927	968
61066	2084 x 1981	673	714	673	714	673	714	928	969
61070	2084 x 2136	722	763	722	763	722	763	976	1017
7060	2134 x 1830	-	-	-	-	-	-	-	-
7063	2134 x 1905	-	-	-	-	-	-	-	-
7064	2134 x 1931	673	714	673	714	673	714	928	969
7066	2134 x 1981	673	714	673	714	673	714	928	969
7070	2134 x 2136	713	754	713	754	713	754	967	1008
7076	2134 x 2286	-	848	-	848	-	848	-	1102
7164	2170 x 1931	673	714	673	714	673	714	928	969
7166	2170 x 1981	673	714	673	714	673	714	928	969
7170	2170 x 2136	713	754	713	754	713	754	967	1008
7176	2170 x 2286	-	919	-	919	-	919	-	1173
7364	2224 x 1931	748	789	748	789	748	789	1003	1044
7366	2224 x 1981	753	794	753	794	753	794	1007	1048
7370	2224 x 2136	758	799	758	799	758	799	1012	1053
7564	2259 x 1931	748	789	748	789	748	789	1003	1044
7566	2259 x 1981	748	789	748	789	748	789	1003	1044
7570	2259 x 2136	863	904	863	904	863	904	1118	1159
7576	2259 x 2286	-	1047	-	1047	-	1047	-	1301
7664	2284 x 1931	748	789	748	789	748	789	1003	1044
7666	2284 x 1981	748	789	748	789	748	789	1003	1044
7670	2284 x 2136	863	904	863	904	863	904	1118	1159
7676	2284 x 2286	-	1047	-	1047	-	1047	-	1301
8064	2439 x 1931	887	928	887	928	887	928	1142	1183
8066	2439 x 1981	887	928	887	928	887	928	1142	1183
8070	2439 x 2136	924	965	924	965	924	965	1178	1219
8076	2439 x 2286	-	1028	-	1028	-	1028	-	1323
8666	2590 x 1981	-	946	-	946	-	946	-	1241
8670	2590 x 2136	-	956	-	956	-	956	-	1252
8676	2590 x 2286	-	1060	-	1060	-	1060	-	1355
9066	2744 x 1981	-	961	-	961	-	961	-	1257
9070	2744 x 2136	-	972	-	972	-	972	-	1267
9076	2744 x 2286	-	1076	-	1076	-	1076	-	1371
1066	3049 x 1981	-	998	-	998	-	998	-	1293
1070	3049 x 2136	-	1018	-	1018	-	1018	-	1314

¹ Windows for Beaumont: Standard (□), Diamond (◊), Cross (⊕). Please state on order if clear or crystal panes.

Prices in bold show stock doors on a one-week lead-time. All other prices are non-stock standard doors on a two to four week lead-time.

Please note that doors with windows may have cross bracing or locking rods passing behind the windows depending upon size and gear type.

For further options please see page 15.

Single door

Size Internal Timber
Code frame opening
Width x Height
(mm x mm)

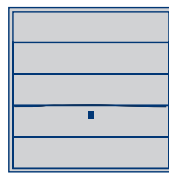

Wentwood

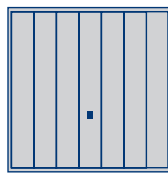

Sherwood

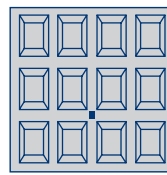
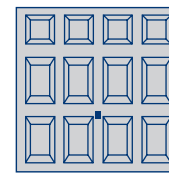
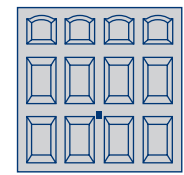
Georgian
Timber EffectBeaumont
Timber EffectCathedral
Timber Effect

Size Code	Internal Timber frame opening Width x Height (mm x mm)	Wentwood		Sherwood		Georgian Timber Effect		Beaumont Timber Effect		Cathedral Timber Effect	
		C	R	C	R	C	R	C	R	C	R
6660	1984 x 1830	-	-	-	-	-	-	-	-	-	-
6663	1984 x 1905	-	-	-	-	-	-	-	-	-	-
6664	1984 x 1931	-	-	-	-	806	847	806	847	806	847
6666	1984 x 1981	-	-	-	-	806	847	806	847	806	847
6670	1984 x 2136	-	-	-	-	845	886	845	886	845	886
61064	2084 x 1931	-	-	-	-	806	847	806	847	806	847
61066	2084 x 1981	-	-	-	-	806	847	806	847	806	847
61070	2084 x 2136	-	-	-	-	845	886	845	886	845	886
7060	2134 x 1830	-	-	-	-	-	-	-	-	-	-
7063	2134 x 1905	-	-	-	-	-	-	-	-	-	-
7064	2134 x 1931	-	-	-	-	806	847	806	847	806	847
7066	2134 x 1981	590	631	683	724	806	847	806	847	806	847
7070	2134 x 2136	655	696	705	746	845	886	845	886	845	886
7076	2134 x 2286	-	-	-	-	-	937	-	937	-	937
7164	2170 x 1931	-	-	-	-	806	847	806	847	806	847
7166	2170 x 1981	-	-	-	-	806	847	806	847	806	847
7170	2170 x 2136	-	-	-	-	845	886	845	886	845	886
7176	2170 x 2286	-	-	-	-	-	937	-	937	-	937
7364	2224 x 1931	-	-	-	-	806	847	806	847	806	847
7366	2224 x 1981	-	-	-	-	806	847	806	847	806	847
7370	2224 x 2136	-	-	-	-	845	886	845	886	845	886
7564	2259 x 1931	-	-	-	-	896	937	896	937	896	937
7566	2259 x 1981	671	712	729	770	896	937	896	937	896	937
7570	2259 x 2136	747	788	787	828	896	937	896	937	896	937
7576	2259 x 2286	-	-	-	-	-	1090	-	1090	-	1090
7664	2284 x 1931	-	-	-	-	896	937	896	937	896	937
7666	2284 x 1981	671	712	729	770	896	937	896	937	896	937
7670	2284 x 2136	747	788	787	828	1039	1080	1039	1080	1039	1080
7676	2284 x 2286	-	-	-	-	-	1130	-	1130	-	1130
8064	2439 x 1931	-	-	-	-	1056	1097	1056	1097	1056	1097
8066	2439 x 1981	741	782	840	881	1056	1097	1056	1097	1056	1097
8070	2439 x 2136	768	809	866	907	1093	1134	1093	1134	1093	1134
8076	2439 x 2286	-	-	-	-	-	1184	-	1184	-	1184
8666	2590 x 1981	-	-	-	-	-	1107	-	1107	-	1107
8670	2590 x 2136	-	-	-	-	-	1117	-	1117	-	1117
8676	2590 x 2286	-	-	-	-	-	1168	-	1168	-	1168
9066	2744 x 1981	-	-	-	-	-	1120	-	1120	-	1120
9070	2744 x 2136	-	-	-	-	-	1130	-	1130	-	1130
9076	2744 x 2286	-	-	-	-	-	1181	-	1181	-	1181
1066	3049 x 1981	-	-	-	-	-	1151	-	1151	-	1151
1070	3049 x 2136	-	-	-	-	-	1161	-	1161	-	1161

Prices in bold show stock doors on a one-week lead-time. All other prices are non-stock standard doors on a three to four week lead-time.

For further options please see page 15.

Single door

Internal Timber
frame opening
Width x Height
(mm x mm)

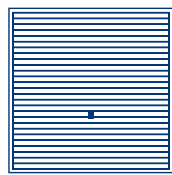

Horizon

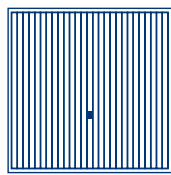

Carlton

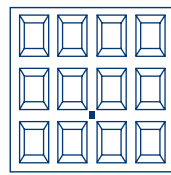

Georgian

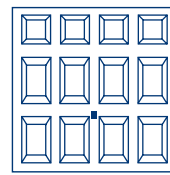

Beaumont

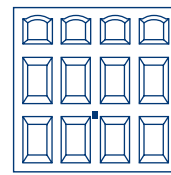

Cathedral

		Horizon		Carlton		Georgian		Beaumont		Cathedral	
		C	R	C	R	C	R	C	R	C	R
1830-1930	x 1830-1930	668	709	693	734	-	-	-	-	-	-
1830-1930	x 1931-1981	692	733	719	760	-	-	-	-	-	-
1830-1930	x 1982-2136	745	786	761	802	-	-	-	-	-	-
1830-1930	x 2137-2286	-	839	-	867	-	-	-	-	-	-
1830-1930	x 2287-2439	-	900	-	924	-	-	-	-	-	-
1931-1984	x 1830-1930	672	713	702	743	-	-	-	-	-	-
1931-1984	x 1931-1981	698	739	725	766	-	-	-	-	-	-
1931-1984	x 1982-2136	740	781	766	807	-	-	-	-	-	-
1931-1984	x 2137-2286	-	839	-	867	-	-	-	-	-	-
1931-1984	x 2287-2439	-	900	-	924	-	-	-	-	-	-
1985-2134	x 1830-1930	698	739	724	765	-	-	-	-	-	-
1985-2134	x 1931-1981	740	781	766	807	1054	1095	1054	1095	1054	1095
1985-2134	x 1982-2136	799	840	815	856	1119	1160	1119	1160	1119	1160
1985-2134	x 2137-2286	-	900	-	924	-	1229	-	1229	-	1229
1985-2134	x 2287-2439	-	956	-	974	-	1186	-	1186	-	1186
2135-2284	x 1830-1930	740	781	756	797	-	-	-	-	-	-
2135-2284	x 1931-1981	799	840	815	856	1129	1170	1129	1170	1129	1170
2135-2284	x 1982-2136	849	890	876	917	1129	1170	1129	1170	1129	1170
2135-2284	x 2137-2286	-	956	-	974	-	1219	-	1219	-	1219
2135-2284	x 2287-2439	-	1017	-	1042	-	1388	-	1388	-	1388
2285-2499 ¹	x 1830-1930	799	840	825	866	-	-	-	-	-	-
2285-2499 ¹	x 1931-1981	849	890	876	917	1198	1239	1198	1239	1198	1239
2285-2499 ¹	x 1982-2136	856	897	924	965	1219	1260	1219	1260	1219	1260
2285-2499	x 2137-2286	-	977	-	998	-	1296	-	1296	-	1296
2285-2499	x 2287-2439	-	1018	-	1029	-	1348	-	1348	-	1348
2500-2590	x 1830-1930	-	915	-	932	-	-	-	-	-	-
2500-2590	x 1931-1981	-	956	-	974	-	1285	-	1285	-	1285
2500-2590	x 1982-2136	-	1018	-	1018	-	1307	-	1307	-	1307
2500-2590	x 2137-2286	-	1029	-	1029	-	1337	-	1337	-	1337
2500-2590	x 2287-2439	-	1091	-	1091	-	1379	-	1379	-	1379
2591-2722	x 1830-1930	-	972	-	972	-	-	-	-	-	-
2591-2722	x 1931-1981	-	1013	-	1013	-	1290	-	1290	-	1290
2591-2722	x 1982-2136	-	1084	-	1084	-	1353	-	1353	-	1353
2591-2722	x 2137-2286	-	1151	-	1151	-	1394	-	1394	-	1394
2591-2722	x 2287-2439	-	1227	-	1227	-	-	-	-	-	-
2723-3049	x 1830-1930	-	-	-	1184	-	-	-	-	-	-
2723-3049	x 1931-1981	-	-	-	1226	-	1379	-	1379	-	1379
2723-3049	x 1982-2136	-	-	-	1352	-	1431	-	1431	-	1431

¹ Canopy gear only available up to 2439 wide.

For further options please see page 15.

Single door

Internal Timber frame opening
Width x Height
(mm x mm)

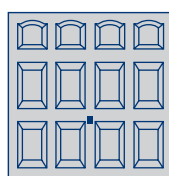
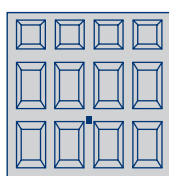
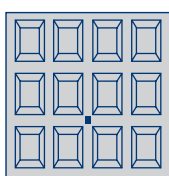
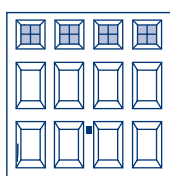

Beaumont with Windows ²

Georgian Timber Effect

Beaumont Timber Effect

Cathedral Timber Effect

C

R

C

R

C

R

C

R

1830-1930	x	1830-1930	-	-	-	-	-	-	-	
1830-1930	x	1931-1981	-	-	-	-	-	-	-	
1830-1930	x	1982-2136	-	-	-	-	-	-	-	
1830-1930	x	2137-2286	-	-	-	-	-	-	-	
1830-1930	x	2287-2439	-	-	-	-	-	-	-	
1931-1984	x	1830-1930	-	-	-	-	-	-	-	
1931-1984	x	1931-1981	-	-	-	-	-	-	-	
1931-1984	x	1982-2136	-	-	-	-	-	-	-	
1931-1984	x	2137-2286	-	-	-	-	-	-	-	
1931-1984	x	2287-2439	-	-	-	-	-	-	-	
1985-2134	x	1830-1930	-	-	-	-	-	-	-	
1985-2134	x	1931-1981	1308	1349	1196	1237	1196	1237	1196	1237
1985-2134	x	1982-2136	1374	1415	1262	1303	1262	1303	1262	1303
1985-2134	x	2137-2286	-	1484	-	1372	-	1372	-	1372
1985-2134	x	2287-2439	-	1441	-	1441	-	1441	-	1441
2135-2284	x	1830-1930	-	-	-	-	-	-	-	-
2135-2284	x	1931-1981	1384	1425	1262	1303	1262	1303	1262	1303
2135-2284	x	1982-2136	1384	1425	1262	1303	1262	1303	1262	1303
2135-2284	x	2137-2286	-	1474	-	1605	-	1605	-	1605
2135-2284	x	2287-2439	-	1643	-	1520	-	1520	-	1520
2285-2499 ¹	x	1830-1930	-	-	-	-	-	-	-	-
2285-2499 ¹	x	1931-1981	1453	1494	1321	1362	1321	1362	1321	1362
2285-2499 ¹	x	1982-2136	1473	1514	1341	1382	1341	1382	1341	1382
2285-2499	x	2137-2286	-	1551	-	1419	-	1419	-	1419
2285-2499	x	2287-2439	-	1603	-	1470	-	1470	-	1470
2500-2590	x	1830-1930	-	-	-	-	-	-	-	-
2500-2590	x	1931-1981	-	1540	-	1397	-	1397	-	1397
2500-2590	x	1982-2136	-	1561	-	1419	-	1419	-	1419
2500-2590	x	2137-2286	-	1592	-	1449	-	1449	-	1449
2500-2590	x	2287-2439	-	1633	-	1491	-	1491	-	1491
2591-2722	x	1830-1930	-	-	-	-	-	-	-	-
2591-2722	x	1931-1981	-	1545	-	1397	-	1397	-	1397
2591-2722	x	1982-2136	-	1608	-	1460	-	1460	-	1460
2591-2722	x	2137-2286	-	1649	-	1501	-	1501	-	1501
2591-2722	x	2287-2439	-	-	-	-	-	-	-	-
2723-3049	x	1830-1930	-	-	-	-	-	-	-	-
2723-3049	x	1931-1981	-	1633	-	1481	-	1481	-	1481
2723-3049	x	1982-2136	-	1685	-	1533	-	1533	-	1533

¹ Canopy gear only available up to 2439 wide.

² Windows for Beaumont: Standard (□), Diamond (◊), Cross (⊕). Please state on order if clear or crystal panes.

Please note that doors with windows may have cross bracing or locking rods passing behind the windows depending upon size and gear type.

For further options please see page 15.

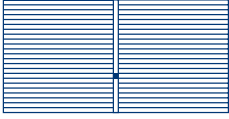
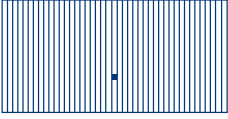
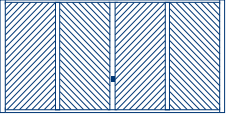
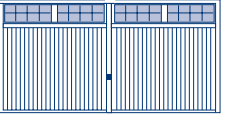
Double door					
Size Code	Internal Timber frame opening Width x Height (mm x mm)	Horizon	Carlton	Chevron	Salisbury
		R	R	R	R
1076	3049 x 2286	1310	1310	-	-
1166	3354 x 1981	1226	1226	-	-
1170	3354 x 2136	1236	1236	-	-
1176	3354 x 2286	1268	1372	-	-
1266	3659 x 1981	1288	1288	-	-
1270	3659 x 2136	1298	1298	-	-
1276	3659 x 2286	1390	1390	-	-
1366	3964 x 1981	1402	1402	-	-
1370	3964 x 2136	1412	1412	-	-
1376	3964 x 2286	1548	1548	-	-
1466	4269 x 1981	1350	1350	1774	1870
1470	4269 x 2136	1350	1350	1774	1870
1566	4574 x 1981	1454	1454	-	-
1570	4574 x 2136	1476	1476	-	-
1666	4879 x 1981	1538	1538	-	-
1670	4879 x 2136	1558	1558	-	-

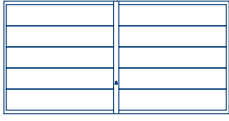
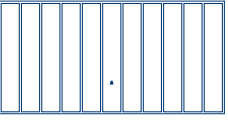
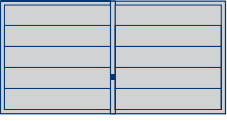
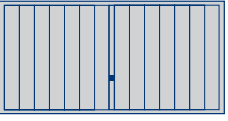
Double door					
Size Code	Internal Timber frame opening Width x Height (mm x mm)	Ascot	Windsor	Wentwood	Sherwood
		R	R	R	R
1076	3049 x 2286	-	-	-	-
1166	3354 x 1981	-	-	-	-
1170	3354 x 2136	-	-	-	-
1176	3354 x 2286	-	-	-	-
1266	3659 x 1981	-	-	-	-
1270	3659 x 2136	-	-	-	-
1276	3659 x 2286	-	-	-	-
1366	3964 x 1981	-	-	-	-
1370	3964 x 2136	-	-	-	-
1376	3964 x 2286	-	-	-	-
1466	4269 x 1981	1426	1426	1704	1745
1470	4269 x 2136	1426	1426	1704	1745
1566	4574 x 1981	-	-	-	-
1570	4574 x 2136	-	-	-	-
1666	4879 x 1981	-	-	-	-
1670	4879 x 2136	-	-	-	-

Prices in bold show stock doors on a one-week lead-time. All other prices are non-stock white standard doors on a two to three week lead-time.

Please note that doors with windows may have cross bracing or locking rods passing behind the windows depending upon size and gear type.

For further options please see page 15.

Double door

Size Code Internal Timber frame opening Width x Height (mm x mm)

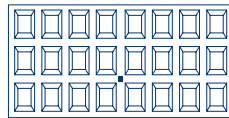

Georgian

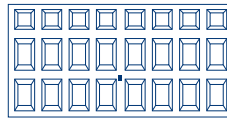

Beaumont

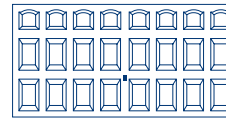

Cathedral

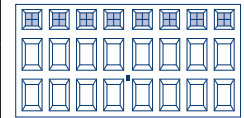

Beaumont with Windows¹

		R	R	R	R
1076	3049 x 2286	1310	1310	1310	1691
1166	3354 x 1981	1288	1288	1288	1671
1170	3354 x 2136	1288	1288	1288	1671
1176	3354 x 2286	1372	1392	1392	1775
1266	3659 x 1981	1372	1372	1372	1753
1270	3659 x 2136	1372	1372	1372	1753
1276	3659 x 2286	1434	1434	1434	1816
1366	3964 x 1981	1413	1413	1413	1795
1370	3964 x 2136	1413	1413	1413	1795
1376	3964 x 2286	1434	1434	1434	1795
1466	4269 x 1981	1454	1454	1454	1963
1470	4269 x 2136	1454	1454	1454	1963
1566	4574 x 1981	1579	1579	1579	1961
1570	4574 x 2136	1579	1579	1579	1961
1666	4879 x 1981	1662	1662	1662	2045
1670	4879 x 2136	1662	1662	1662	2045

¹ Windows for Beaumont: Standard (□), Diamond (◊), Cross (⊞). Please state on order if clear or crystal panes.

Double door

Size Code Internal Timber frame opening Width x Height (mm x mm)

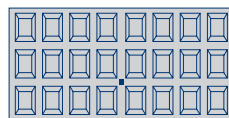

Georgian Timber Effect

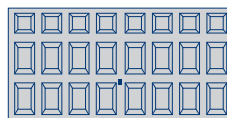

Beaumont Timber Effect

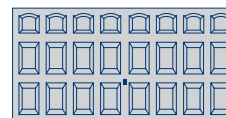

Cathedral Timber Effect

		R	R	R
1076	3049 x 2286	1426	1426	1426
1166	3354 x 1981	1405	1405	1405
1170	3354 x 2136	1405	1405	1405
1176	3354 x 2286	1507	1507	1507
1266	3659 x 1981	1487	1487	1487
1270	3659 x 2136	1487	1487	1487
1276	3659 x 2286	1568	1568	1568
1366	3964 x 1981	1568	1568	1568
1370	3964 x 2136	1568	1568	1568
1376	3964 x 2286	1589	1589	1589
1466	4269 x 1981	1578	1578	1578
1470	4269 x 2136	1578	1578	1578
1566	4574 x 1981	1711	1711	1711
1570	4574 x 2136	1711	1711	1711
1666	4879 x 1981	1833	1833	1833
1670	4879 x 2136	1833	1833	1833

Prices in bold show stock doors on a one-week lead-time. All other prices are non-stock standard doors on a two to three week lead-time, timber effect finishes are on a four to six week lead time.

Please note that doors with windows may have cross bracing or locking rods passing behind the windows depending upon size and gear type.

For further options please see page 15.

Double door

Internal Timber
frame opening
Width x Height
(mm x mm)

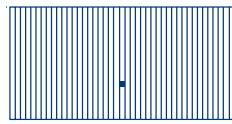

Carlton

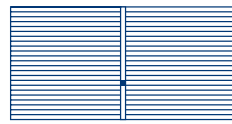

Horizon

		R	R
2745-3049	x 2137-2286	1517	-
2745-3049	x 2287-2439	-	-
3050-3354	x 1886-1981	1434	1454
3050-3354	x 1982-2136	1444	1465
3050-3354	x 2137-2286	1579	1600
3050-3354	x 2287-2439	-	-
3355-3659	x 1886-1981	1476	1496
3355-3659	x 1982-2136	1506	1527
3355-3659	x 2137-2286	1579	1600
3355-3659	x 2287-2439	-	-
3660-3967	x 1886-1981	1610	1631
3660-3967	x 1982-2136	1642	1662
3660-3967	x 2137-2286	1756	1777
3660-3967	x 2287-2439	-	-
3968-4269	x 1886-1981	1558	1579
3968-4269	x 1982-2136	1579	1600
3968-4269	x 2137-2286	-	-
3968-4269	x 2287-2439	-	-
4270-5000	x 1886-1981	1725	1745
4270-5000	x 1982-2136	1766	1787

Double door

Internal Timber
frame opening
Width x Height
(mm x mm)

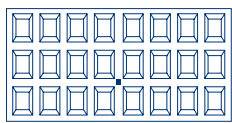

Georgian

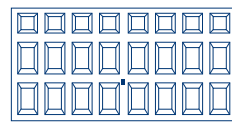

Beaumont

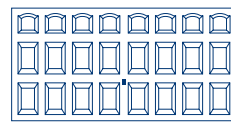

Cathedral

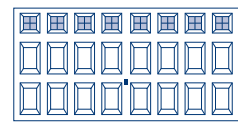

Beaumont with
Windows ¹

		R	R	R	R
2745-3049	x 2137-2286	1517	1517	1517	1779
2745-3049	x 2287-2439	-	-	-	-
3050-3354	x 1931-1981	1496	1496	1496	1879
3050-3354	x 1982-2136	1517	1517	1517	1899
3050-3354	x 2137-2286	1600	1600	1600	1983
3050-3354	x 2287-2439	-	-	-	1961
3355-3659	x 1931-1981	1579	1579	1579	1961
3355-3659	x 1982-2136	1621	1621	1621	2003
3355-3659	x 2137-2286	1642	1642	1642	2023
3355-3659	x 2287-2439	-	-	-	-
3660-3967	x 1931-1981	1621	1621	1621	2129
3660-3967	x 1982-2136	1642	1642	1642	2151
3660-3967	x 2137-2286	1662	1662	1662	2171
3660-3967	x 2287-2439	-	-	-	-
3968-4269	x 1931-1981	1662	1662	1662	2171
3968-4269	x 1982-2136	1662	1662	1662	2171
3968-4269	x 2137-2286	-	-	-	-
3968-4269	x 2287-2439	-	-	-	-
4270-5000	x 1931-1981	1870	1870	1870	2507
4270-5000	x 1982-2136	1870	1870	1870	2507

¹ Windows for Beaumont: Standard (□), Diamond (◊), Cross (⊕). Please state on order if clear or crystal panes.

Please note that doors with windows may have cross bracing or locking rods passing behind the windows depending upon size and gear type.

For further options please see page 15.

Double door

Internal Timber
frame opening
Width x Height
(mm x mm)

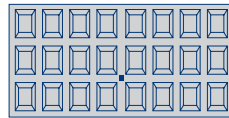

Georgian
Timber Effect

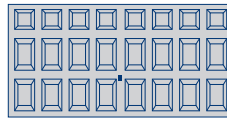

Beaumont
Timber Effect

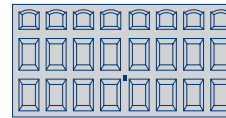

Cathedral
Timber Effect

		R	R	R
2745-3049	x 2137-2286	1670	1670	1670
2745-3049	x 2287-2439	-	-	-
3050-3354	x 1886-1981	1649	1649	1649
3050-3354	x 1982-2136	1670	1670	1670
3050-3354	x 2137-2286	1752	1752	1752
3050-3354	x 2287-2439	-	-	-
3355-3659	x 1886-1981	1742	1742	1742
3355-3659	x 1982-2136	1784	1784	1784
3355-3659	x 2137-2286	1804	1804	1804
3355-3659	x 2287-2439	-	-	-
3660-3967	x 1886-1981	1794	1794	1794
3660-3967	x 1982-2136	1815	1815	1815
3660-3967	x 2137-2286	1835	1835	1835
3660-3967	x 2287-2439	-	-	-
3968-4269	x 1886-1981	1845	1845	1845
3968-4269	x 1982-2136	1845	1845	1845
3968-4269	x 2137-2286	-	-	-
3968-4269	x 2287-2439	-	-	-
4270-5000	x 1886-1981	2053	2053	2053
4270-5000	x 1982-2136	2053	2053	2053

Timber effect finishes are on a four to six week lead time.

For further options please see page 15.

Options	Single doors	Double doors
	add	add
Factory pre-framed standard single doors	102	-
Steel frame for standard double doors	-	153
Factory pre-framed purpose-made single doors (framed retractable purpose made doors require a 4 week lead-time)	112	-
Steel frame for purpose made double doors	-	168
Additional Lock Kit, C-type/ R-type (fitted onto door)	45	-
Retractable plus gear available on 1931, 1981 and 2136 mm high doors up to 2744 mm wide	29	-
For powder-coated doors ¹ : Brown (RAL 8028) ¹	28	55
For powder-coated doors ¹ : Moss Green (RAL 6005), Ruby Red (RAL 3003), Signal Blue (RAL 5005), Jet Black (RAL 9005), Steel Blue (RAL 5011), Light Ivory (RAL 1015), Pigeon Blue (RAL 5014), Fir Green (RAL 6009), Anthracite Grey (RAL 7016), Stone Grey (RAL 7030), Light Grey (RAL 7035), Ochre Brown (RAL 8001), Clay Brown (RAL 8003), White Aluminium (RAL 9006), Grey Aluminium (RAL 9007) and Window Grey (RAL 7040).	99	156
Coloured window frames to match door colour – Beaumont doors (price per window). Beaumont doors up to 3049 wide = 4 windows, between 3050 to 3964 = 6 windows, between 3965 to 4860 = 8 windows and over 4860 = 10 windows.	26 each	26 each
Coloured window frames to match door colour – Salisbury doors (price per door)	124	248
Black window panes for Salisbury doors (price per door)	26	51
Poly-wrapping (available on white and brown)	19	35
Diecast metal handles: brass effect, chrome effect and white	26	26
Bottom weatherseal, 2405 mm length (suitable for gaps up to 15 mm between the door and the floor level)	29	29
Bottom weatherseal, 3000 mm length (suitable for gaps up to 15 mm between the door and the floor level)	33	33

¹ Please state coloured windows required on order. Coloured Beaumont with windows and Salisbury doors are supplied with white or brown window frames as standard.

Please note that doors with windows may have cross bracing or locking rods passing behind the windows depending upon size and gear type.

Guardian Range

New Secured By Design certified Up & Over doors

These doors have been tested to the STS 202 Security Technical Specification and achieve Secured By Design accreditation. New lock body protection, anti-snap cylinder, high security bracing and improved lock security make these doors even more secure.

Information

Guardian Range doors come with a pre-fitted steel frame and cannot be fitted to a custom made timber frame.

There is no mechanism to unlock Guardian range doors from the inside.

Guardian Range doors are not suitable for automation.

Window panes on Secured by Design Salisbury doors are black non-translucent.

Stock availability

All doors from the Guardian Range have an expected lead-time of four to six weeks.

Single door - standard sizes

Size Code	Internal Timber frame opening Width x Height (mm x mm)	Horizon		Carlton		Salisbury	
		C	R	C	R	C	R
6660	1984 x 1830	855	896	925	966	-	-
6663	1984 x 1905	855	896	925	966	-	-
6664	1984 x 1931	855	896	925	966	-	-
6666	1984 x 1981	829	870	896	937	-	-
61064	2084 x 1931	839	880	896	937	-	-
61066	2084 x 1981	851	892	896	937	-	-
61070	2084 x 2136	869	910	906	947	-	-
7060	2134 x 1830	870	911	939	980	-	-
7063	2134 x 1905	870	911	939	980	-	-
7064	2134 x 1931	844	885	898	939	1264	1305
7066	2134 x 1981	787	828	880	921	1264	1305
7070	2134 x 2136	852	893	902	943	1273	1314
7164	2170 x 1931	891	932	936	977	-	-
7166	2170 x 1981	787	828	880	921	-	-
7170	2170 x 2136	906	947	964	1005	-	-
7364	2224 x 1931	888	929	924	965	-	-
7366	2224 x 1981	891	932	927	968	-	-
7370	2224 x 2136	899	940	933	974	-	-
7564	2259 x 1931	916	957	954	995	1298	1339
7566	2259 x 1981	888	929	930	971	1298	1339
7570	2259 x 2136	963	1004	1002	1043	1308	1349
7664	2284 x 1931	888	929	944	985	1298	1339
7666	2284 x 1981	888	929	944	985	1298	1339
7670	2284 x 2136	964	1005	1002	1043	1308	1349
8064	2439 x 1931	-	-	-	1096	-	1397
8066	2439 x 1981	-	-	-	1096	-	1397
8070	2439 x 2136	-	-	-	1119	-	1407
8666	2590 x 1981	-	-	-	1158	-	-
8670	2590 x 2136	-	-	-	1193	-	-
9066	2744 x 1981	-	-	-	1218	-	-
9070	2744 x 2136	-	-	-	1265	-	-

Single door - purpose-made sizes

Internal Timber
frame opening
Width x Height
(mm x mm)

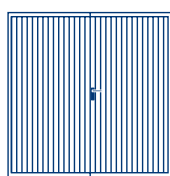
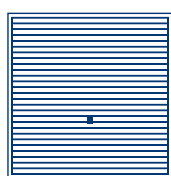

		Horizon		Carlton	
		C	R	C	R
1985-2134	x 1830-1930	1048	1089	1074	1115
1985-2134	x 1931-1981	1090	1131	1116	1157
1985-2134	x 1982-2136	1150	1191	1165	1206
2135-2284	x 1830-1930	1090	1131	1106	1147
2135-2284	x 1931-1981	1150	1191	1150	1191
2135-2284	x 1982-2136	1199	1240	1226	1267
2285-2499	x 1830-1930	-	1191	-	1216
2285-2499	x 1931-1981	-	1240	-	1267
2285-2499	x 1982-2136	-	1237	-	1315
2500-2590	x 1830-1930	-	1282	-	1282
2500-2590	x 1931-1981	-	1324	-	1324
2500-2590	x 1982-2136	-	1369	-	1369
2591-2722	x 1830-1930	-	1322	-	1322
2591-2722	x 1931-1981	-	1364	-	1364
2591-2722	x 1982-2136	-	1434	-	1434

Options for single doors

add

For powder-coated doors: Brown (RAL 8028)

28

For powder coated doors: Moss Green (RAL 6005), Ruby Red (RAL 3003), Signal Blue (RAL 5005), Jet Black (RAL 9005), Steel Blue (RAL 5011), Light Ivory (RAL 1015), Pigeon Blue (RAL 5014), Fir Green (RAL 6009), Anthracite Grey (RAL 7016), Stone Grey (RAL 7030), Light Grey (RAL 7035), Ochre Brown (RAL 8001), Clay Brown (RAL 8003), White Aluminium (RAL 9006), Grey Aluminium (RAL 9007) and Window Grey (RAL 7040).

99

Coloured window frames on Salisbury to match door colour

124

Retractable plus gear (available up to 80 (2439) wide but in standard heights only - 64 (1931), 66 (1981) and 70 (2134))

29



Secured by Design is an association focusing on the design of more secure homes and commercial properties. Secured by Design is owned by the ACPO (Association of Chief Police Officers) and awards the Secured by Design status to products that pass their extensive testing procedures.

Design Range

Surface and finish

The Series 100 Design Range skins are built from four horizontal skins, whilst the Series 200 range is constructed from three vertical skins. Stainless steel elements on Garador design range doors are manufactured from high grade 2mm thick steel with a brushed finish. The series 100 and 200 design range doors are also available without stainless steel elements.

On Design Range doors a choice of any standard colour comes free of charge, please see page 19 for a choice of the 19 standard RAL colours available. The Titan Metallic colour is a structured metallic finish is only available on Design Range doors.

Please note: panel doors are produced with appearance in mind. This may result in some small gaps which could allow water ingress especially in exposed locations.

Handle and Packaging

A new perfectly matched handle offers a quality feel everytime you open the door. Design Range doors come wrapped as standard.

Single door

Size Internal Timber
Code frame opening
Width x Height
(mm x mm)

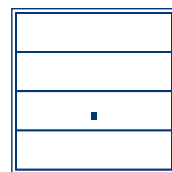

100

C R

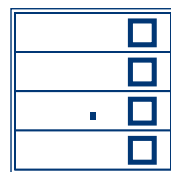

101

C R

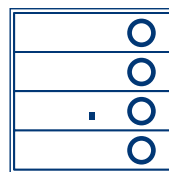

102

C R

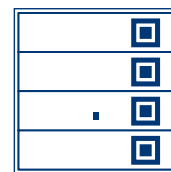

103

C R

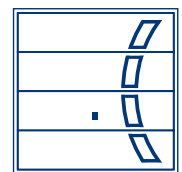

104

C R

7066	2134 x 1981	779	820	935	976	935	976	935	976	935	976
7070	2134 x 2136	831	872	987	1028	987	1028	987	1028	987	1028
7566	2259 x 1981	857	898	1013	1054	1013	1054	1013	1054	1013	1054
7570	2259 x 2136	909	950	1065	1106	1065	1106	1065	1106	1065	1106
7666	2284 x 1981	873	914	1028	1069	1028	1069	1028	1069	1028	1069
7670	2284 x 2136	925	966	1080	1121	1080	1121	1080	1121	1080	1121
8066	2439 x 1981	987	1028	1142	1183	1142	1183	1142	1183	1142	1183
8070	2439 x 2136	1039	1080	1194	1235	1194	1235	1194	1235	1194	1235

Single door

Size Internal Timber
Code frame opening
Width x Height
(mm x mm)

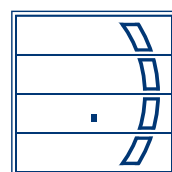

105

C R



106

C R

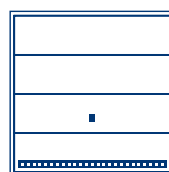

107

C R

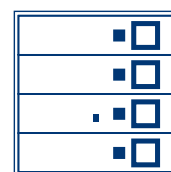

108

C R

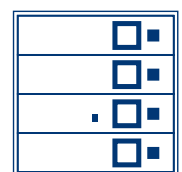

109

C R

7066	2134 x 1981	935	976	935	976	935	976	935	976	935	976
7070	2134 x 2136	987	1028	987	1028	987	1028	987	1028	987	1028
7566	2259 x 1981	1013	1054	1013	1054	1013	1054	1013	1054	1013	1054
7570	2259 x 2136	1065	1106	1065	1106	1065	1106	1065	1106	1065	1106
7666	2284 x 1981	1028	1069	1028	1069	1028	1069	1028	1069	1028	1069
7670	2284 x 2136	1080	1121	1080	1121	1080	1121	1080	1121	1080	1121
8066	2439 x 1981	1142	1183	1142	1183	1142	1183	1142	1183	1142	1183
8070	2439 x 2136	1194	1235	1194	1235	1194	1235	1194	1235	1194	1235

Single door

Size Internal Timber
Code frame opening
Width x Height
(mm x mm)

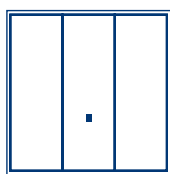

200

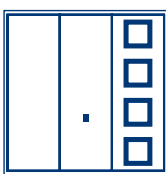

201

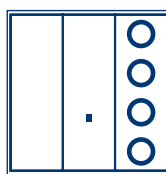

202

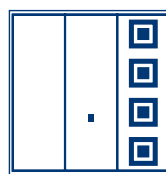

203

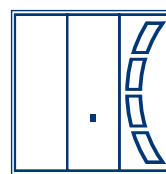

204

		C	R	C	R	C	R	C	R	C	R
7066	2134 x 1981	779	820	935	976	935	976	935	976	935	976
7070	2134 x 2136	831	872	987	1028	987	1028	987	1028	987	1028
7566	2259 x 1981	857	898	1013	1054	1013	1054	1013	1054	1013	1054
7570	2259 x 2136	909	950	1065	1106	1065	1106	1065	1106	1065	1106
7666	2284 x 1981	873	914	1028	1069	1028	1069	1028	1069	1028	1069
7670	2284 x 2136	925	966	1080	1121	1080	1121	1080	1121	1080	1121
8066	2439 x 1981	987	1028	1142	1183	1142	1183	1142	1183	1142	1183
8070	2439 x 2136	1039	1080	1194	1235	1194	1235	1194	1235	1194	1235

Single door

Size Internal Timber
Code frame opening
Width x Height
(mm x mm)

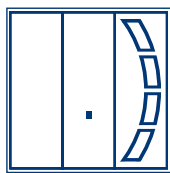

205

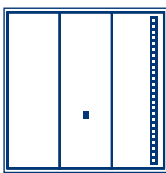

207

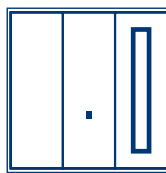

210

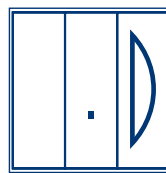

211

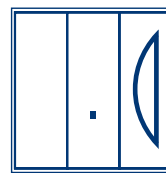

212

		C	R	C	R	C	R	C	R	C	R
7066	2134 x 1981	935	976	935	976	935	976	935	976	935	976
7070	2134 x 2136	987	1028	987	1028	987	1028	987	1028	987	1028
7566	2259 x 1981	1013	1054	1013	1054	1013	1054	1013	1054	1013	1054
7570	2259 x 2136	1065	1106	1065	1106	1065	1106	1065	1106	1065	1106
7666	2284 x 1981	1028	1069	1028	1069	1028	1069	1028	1069	1028	1069
7670	2284 x 2136	1080	1121	1080	1121	1080	1121	1080	1121	1080	1121
8066	2439 x 1981	1142	1183	1142	1183	1142	1183	1142	1183	1142	1183
8070	2439 x 2136	1194	1235	1194	1235	1194	1235	1194	1235	1194	1235

Options for single doors

add

Factory pre-fitted steel frame

102

Additional Lock Kit, C-type/ R-type (fitted onto door)

45

Retractable plus gear

29

Titan metallic paint finish (exclusive to Design Range doors)

51

Please specify on order if you would like the design elements on the right or the left hand side of the door panel (viewed from outside).

Colour options on Design Range doors are free of charge. Available options are: White (RAL 9016), Terra Brown (RAL 8028), Moss Green (RAL 6005), Ruby Red (RAL 3003), Signal Blue (RAL 5005), Jet Black (RAL 9005), Steel Blue (RAL 5011), Light Ivory (RAL 1015), Pigeon Blue (RAL 5014), Fir Green (RAL 6009), Anthracite Grey (RAL 7016), Stone Grey (RAL 7030), Light Grey (RAL 7035), Ochre Brown (RAL 8001), Clay Brown (RAL 8003), White Aluminium (RAL 9006), Grey Aluminium (RAL 9007) and Window Grey (RAL 7040).

Design Range doors come wrapped as standard

PVC Panel Doors

Surface

Low gloss white finish panels fixed as an infill into a rigid box section chassis in White (RAL 9016).

Please note: panel doors are produced with appearance in mind. This may result in some small gaps which could allow water ingress especially in exposed locations.

Handle

Black handle as standard, optional handles are available. Doors can be supplied without handle holes but will increase the lead time.

Packaging

These doors are provided with a film on the front face to protect the door, this must be removed when fitted.

Stock availability

Standard sized doors are ex-stock on a one-week lead-time. Purpose made sizes on a 4 week lead-time.

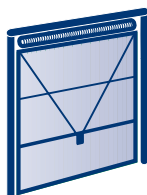

Canopy gearing

Canopy Gearing is available for all single doors providing a reliable and affordable gearing solution, with no tracks running back into the garage.

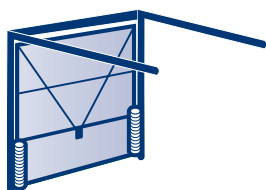

Retractable Gearing

Retractable Gearing is available for all single and double doors providing a reliable and affordable gearing solution, with tracks running back into the garage.

Single door - standard sizes

Size Code	Internal Timber frame opening Width x Height (mm x mm)	Chatsworth		Sherborne	
		C	R	C	R
7066	2134 x 1981	760	801	760	801
7070	2134 x 2136	760	801	760	801
7566	2259 x 1981	821	862	821	862
7570	2259 x 2136	821	862	821	862
7666	2284 x 1981	827	868	827	868
7670	2284 x 2136	827	868	827	868
8066	2439 x 1981	893	934	893	934
8070	2439 x 2136	893	934	893	934

Single door - purpose made sizes

Internal Timber frame opening Width x Height (mm x mm)	Chatsworth		Sherborne	
	C	R	C	R
2084-2134 x 1981-2136	967	1008	967	1008
2135-2284 x 1981-2136	1035	1076	1035	1076
2285-2439 x 1981-2136	1101	1142	1101	1142

Options for single doors

	add
Factory pre-framed standard door size finished in white to match door chassis	102
Factory pre-framed purpose made doors	112
Retractable plus gear option on 1981 mm and 2136 mm high doors	29
Diecast metal handles: brass effect, chrome effect and white	26
Poly-wrapping	19
Bottom weatherseal, 2405 mm length (suitable for gaps up to 15 mm between the door and the floor level)	29
Bottom weatherseal, 3000 mm length (suitable for gaps up to 15 mm between the door and the floor level)	33
Additional Lock Kit, C-type / R-type (fitted onto door)	45

GRP Premier Panel Doors

Surface

High gloss or woodgrain finish depending on door style.

GRP Premier doors are constructed as an infill panel and are fixed into a rigid box section chassis.

The infill has a flow coat to the inside face for a smoother finish and reduced translucency. Doors without flow coat are available.

Please note: panel doors are produced with appearance in mind. This may result in some small gaps which could allow water ingress especially in exposed locations.

Colours

Ashurst, Arden and Stamford are available in Gloss White finish only. All other doors are available in the following range of woodgrain colours: Ebony, Matt white, Cherry Oak, Light Oak, Golden Oak, Rosewood, Honey, Golden Brown and Dark Oak.

Due to the production processes door colours may vary. Should you require matching doors please specify on your order.

Chassis colour - White (RAL 9016) for Gloss White Doors, Black (RAL 9005) for Ebony coloured doors and Brown (RAL 8028) for all other timber effect GRP doors.

Handle

Black handle and base plate as standard, optional handles available. Doors can be supplied undrilled and without handle and locking mechanism for use with electric operator. This must be requested at the time of order.

Certain panel configurations may only be available without handle or locking, therefore only suitable for electric operation (consult Garador sales office for exact details).

Packaging

Supplied with front surface protection as standard.

Stock availability

All GRP doors are made to order and thus require an approximate lead-time of 4 weeks.

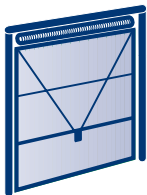

Canopy gearing

Canopy Gearing is available for all single doors providing a reliable and affordable gearing solution, with no tracks running back into the garage.

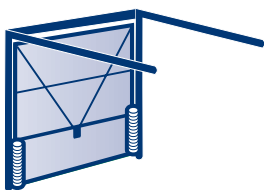

Retractable Gearing

Retractable Gearing is available for all single and double doors providing a reliable and affordable gearing solution, with tracks running back into the garage.

Single door

Size Code	Internal Timber frame opening Width x Height (mm x mm)	Arden		Ashurst		Kenmore		Stamford		Penshurst	
		C	R	C	R	C	R	C	R	C	R
7066	2134 x 1981	1561	1602	1561	1602	1594	1635	1639	1680	1691	1732
7070	2134 x 2136	1561	1602	1561	1602	1594	1635	1639	1680	1691	1732
7566	2259 x 1981	1633	1674	1633	1674	1677	1718	1707	1748	1823	1864
7570	2259 x 2136	1633	1674	1633	1674	1677	1718	1707	1748	1823	1864
7666	2284 x 1981	1647	1688	1647	1688	1691	1732	1725	1766	1840	1881
7670	2284 x 2136	1647	1688	1647	1688	1691	1732	1725	1766	1840	1881
8066	2439 x 1981	1798	1839	1798	1839	1818	1859	1867	1908	1959	2000
8070	2439 x 2136	1798	1839	1798	1839	1818	1859	1867	1908	1959	2000
9066	2744 x 1981	-	2005 ¹	-	2005 ¹	-	2051 ¹	-	2068 ¹	-	-
9070	2744 x 2136	-	2005 ¹	-	2005 ¹	-	2051 ¹	-	2068 ¹	-	-
1066	3049 x 1981	-	2202 ¹	-	2202 ¹	-	2272 ¹	-	2298 ¹	-	2409
1070	3049 x 2136	-	2202 ¹	-	2202 ¹	-	2272 ¹	-	2298 ¹	-	2409

¹ Doors only available with electric operation (Handle and Locking not available).

Single door

Size Code	Internal Timber frame opening Width x Height (mm x mm)	Hartfield ²		Lingfield		Swinton		Hazelbury		Derwent	
		C	R	C	R	C	R	C	R	C	R
7066	2134 x 1981	1691	1732	1691	1732	1691	1732	1821	1862	1869	1910
7070	2134 x 2136	1691	1732	1691	1732	1691	1732	1821	1862	1869	1910
7566	2259 x 1981	1823	1864	1823	1864	1823	1864	1923	1964	2002	2043
7570	2259 x 2136	1823	1864	1823	1864	1823	1864	1923	1964	2002	2043
7666	2284 x 1981	1840	1881	1840	1881	1840	1881	1938	1979	2019	2060
7670	2284 x 2136	1840	1881	1840	1881	1840	1881	1938	1979	2019	2060
8066	2439 x 1981	-	-	1959	2000	1959	2000	2066	2107	2136	2177
8070	2439 x 2136	-	-	1959	2000	1959	2000	2066	2107	2136	2177
9066	2744 x 1981	-	-	-	-	-	-	-	-	-	-
9070	2744 x 2136	-	-	-	-	-	-	-	-	-	-
1066	3049 x 1981	-	-	-	-	-	-	-	-	-	-
1070	3049 x 2136	-	-	-	-	-	-	-	-	-	-

² Hartfield doors not available in matt white colour option.

Please note that doors with windows may have cross bracing or locking rods passing behind the windows depending upon size and gear type.

For further options please see page 28.

Single door

Internal Timber frame opening
Width x Height
(mm x mm)

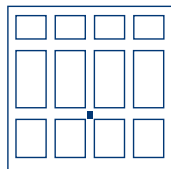
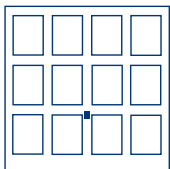
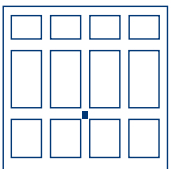
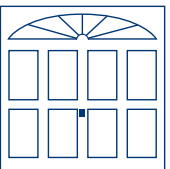
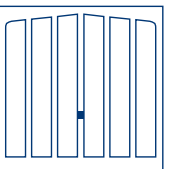
										
	Arden		Ashurst ²		Kenmore		Stamford		Penshurst ³	
	C	R	C	R	C	R	C	R	C	R
Up to 2133 x 1931-1980	-	-	-	-	-	-	-	-	1867	1908
Up to 2133 x 1981-2136	-	-	1723	1764	-	-	-	-	1867	1908
Up to 2133 x 2137-2286	-	-	1978	2019	-	-	-	-	-	2157
2134-2439 x 1931-1980	-	-	-	-	-	-	-	-	2144	2185
2134-2439 x 1981-2136	1971	2012	1971	2012	1993	2034	2049	2090	2144	2185
2134-2439 x 2137-2286	-	-	-	2335	-	-	-	-	-	2482
2440-2590 x 1931-1980	-	-	-	-	-	-	-	-	-	-
2440-2590 x 1981-2136	-	2249 ¹	-	2249 ¹	-	2296	-	2367 ¹	-	-
2440-2590 x 2137-2286	-	-	-	2575	-	-	-	-	-	-
2591-2744 x 1931-1980	-	-	-	-	-	-	-	-	-	-
2591-2744 x 1981-2136	-	2249 ¹	-	2249 ¹	-	2296 ¹	-	2314 ¹	-	-
2591-2744 x 2137-2286	-	-	-	2575 ¹	-	-	-	-	-	-
2745-2896 x 1931-1980	-	-	-	-	-	-	-	-	-	-
2745-2896 x 1981-2136	-	2443 ¹	-	2443 ¹	-	2511 ¹	-	2599 ¹	-	-
2745-2896 x 2137-2286	-	-	-	2792 ¹	-	-	-	-	-	-
2897-3049 x 1931-1980	-	-	-	-	-	-	-	-	-	2665
2897-3049 x 1981-2136	-	2443 ¹	-	2443 ¹	-	2511 ¹	-	2599 ¹	-	2665
2897-3049 x 2137-2286	-	-	-	2752 ¹	-	-	-	-	-	2975

¹ Doors only available with electric operation (Handle and Locking not available).

² Ashurst width available from 2016 mm.

³ Penshurst width available from 2083 mm.

Single door

Internal Timber frame opening
Width x Height
(mm x mm)

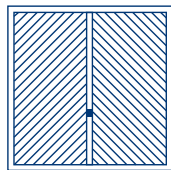
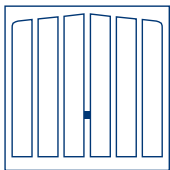
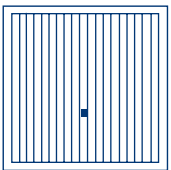
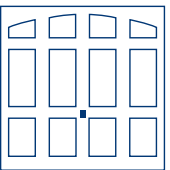
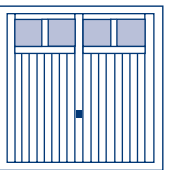
										
	Hartfield ⁴		Lingfield		Swinton		Hazelbury		Derwent	
	C	R	C	R	C	R	C	R	C	R
Up to 2133 x 1931-1980	-	-	-	-	-	-	-	-	-	-
Up to 2133 x 1981-2136	-	-	-	-	-	-	-	-	-	-
Up to 2133 x 2137-2286	-	-	-	-	-	-	-	-	-	-
2134-2439 x 1931-1980	-	-	-	-	-	-	2144	2185	-	-
2134-2439 x 1981-2136	2144	2185	2144	2185	2144	2185	2144	2185	2279	2320
2134-2439 x 2137-2286	-	-	-	-	-	-	-	-	-	-
2440-2590 x 1931-1980	-	-	-	-	-	-	-	-	-	-
2440-2590 x 1981-2136	-	-	-	-	-	-	-	-	-	-
2440-2590 x 2137-2286	-	-	-	-	-	-	-	-	-	-
2591-2744 x 1931-1980	-	-	-	-	-	-	-	-	-	-
2591-2744 x 1981-2136	-	-	-	-	-	-	-	-	-	-
2591-2744 x 2137-2286	-	-	-	-	-	-	-	-	-	-
2745-2896 x 1931-1980	-	-	-	-	-	-	-	-	-	-
2745-2896 x 1981-2136	-	-	-	-	-	-	-	-	-	-
2745-2896 x 2137-2286	-	-	-	-	-	-	-	-	-	-
2897-3049 x 1931-1980	-	-	-	-	-	-	-	-	-	-
2897-3049 x 1981-2136	-	-	-	-	-	-	-	-	-	-
2897-3049 x 2137-2286	-	-	-	-	-	-	-	-	-	-

⁴ Hartfield doors not available in matt white colour option and only upto 2286 mm wide.

Please note that doors with windows may have cross bracing or locking rods passing behind the windows depending upon size and gear type.

For further options please see page 28.

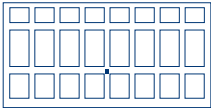
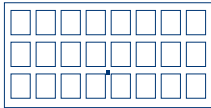
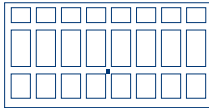
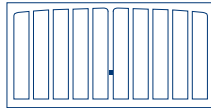
Double door					
Size Code	Internal Timber frame opening Width x Height (mm x mm)	Arden R	Ashurst R	Kenmore R	Penshurst R
1166	3354 x 1981	2202	-	2289	2411
1170	3354 x 2136	2202	-	2289	2411
1266	3659 x 1981	2383 ¹	-	2487 ¹	2614
1270	3659 x 2136	2383 ¹	-	2487 ¹	2614
1366	3964 x 1981	2560 ¹	-	2688 ¹	2813
1370	3964 x 2136	2560 ¹	-	2688 ¹	2813
1466	4269 x 1981	2739	2739	2894	3014
1470	4269 x 2136	2739	2739	2894	3014

¹ Doors only available with electric operation (Handle and Locking not available).

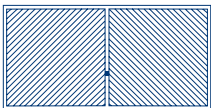
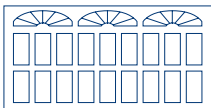
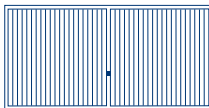
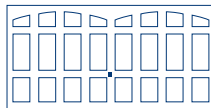
Double door					
Size Code	Internal Timber frame opening Width x Height (mm x mm)	Hartfield ² R	Stamford R	Swinton R	Hazelbury R
1166	3354 x 1981	-	-	-	-
1170	3354 x 2136	-	-	-	-
1266	3659 x 1981	-	-	-	-
1270	3659 x 2136	-	-	-	-
1366	3964 x 1981	-	-	-	-
1370	3964 x 2136	-	-	-	-
1466	4269 x 1981	-	3026 ¹	3026	3173
1470	4269 x 2136	3014	3026 ¹	3026	3173

¹ Doors only available with electric operation (Handle and Locking not available).

² Hartfield doors not available in matt white colour option.

Please note that doors with windows may have cross bracing or locking rods passing behind the windows depending upon size and gear type.

For further options please see page 28.

Double door

Internal Timber
frame opening
Width x Height
(mm x mm)

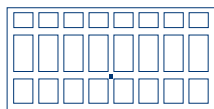

Arden

R

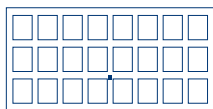

Ashurst

R

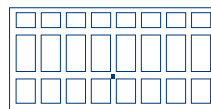

Kenmore

R

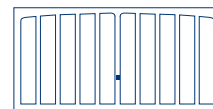

Penshurst

R

3050-3355	x	1981-2136	2352	-	2449	3574
3050-3355	x	2137-2286	-	-	-	2963
3356-3660	x	1981-2136	2529 ¹	-	2646 ¹	2774
3356-3660	x	2137-2286	-	-	-	3187
3661-3965	x	1981-2136	2705 ¹	-	2845 ¹	2576
3661-3965	x	2137-2286	-	-	-	3419
3966-4117	x	1981-2136	2882 ¹	2882 ²	3036 ¹	3161
3966-4117	x	2137-2286	-	3316 ²	-	3915
4118-4269	x	1981-2136	2882	2882	3036	3161
4118-4269	x	2137-2286	-	3316	-	3638

¹ Doors only available with electric operation (Handle and Locking not available).

² Only available from 4000 mm.

Double door

Internal Timber
frame opening
Width x Height
(mm x mm)

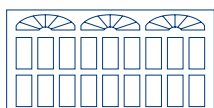

Stamford

R

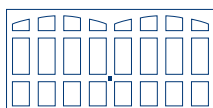

Hazelbury

R











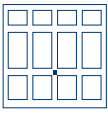
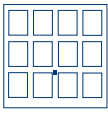
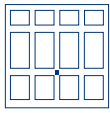
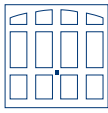

3050-3355	x	1981-2136	-	-
3050-3355	x	2137-2286	-	-
3356-3660	x	1981-2136	-	-
3356-3660	x	2137-2286	-	-
3661-3965	x	1981-2136	-	-
3661-3965	x	2137-2286	-	-
3966-4117	x	1981-2136	3184 ¹	-
3966-4117	x	2137-2286	-	-
4118-4269	x	1981-2136	3184 ¹	3213
4118-4269	x	2137-2286	-	-

¹ Doors only available with electric operation (Handle and Locking not available).

For further options please see page 28.

**GRP
Window options**











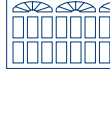

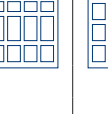
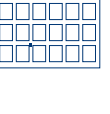
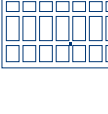
for standard
and purpose-made
single doors

						Additional Cost (Width mm)		
						up to 2743	2744-3049	
	Stamford	Arden	Ashurst	Kenmore	Hazelbury	up to 2743	2744-3049	Derwent
 Semi-translucent, no leading	A	A	A	A	A	145	217	no on-cost
 Semi-translucent, diamond leading	-	B	B	B	B	242	358	Add £ 94
 Semi-translucent, square leading	-	C	C	C	C	242	358	Add £ 94
 Smoked, no leading	D	D	-	D	D	146	217	no on-cost
 Smoked, diamond leading	-	E	-	E	E	242	358	Add £ 94
 Smoked, square leading	-	F	-	F	F	242	358	Add £ 94
 Imitation black, sunrise	G	-	-	-	-	35	55	-
 Imitation black, no leading	-	H	H	H	H	146	217	no on-cost
 Imitation black, square leading	-	I	I	I	I	242	358	Add £ 94
 Imitation black, diamond leading	-	J	J	J	j	242	358	Add £ 94

Please state window code on order.

**GRP
Window options**

for standard
and purpose-made
double doors

						Additional Cost (Width mm)	
						3354 - 3963	3964 - 4269
	Stamford	Arden	Ashurst	Kenmore	Hazelbury	3354 - 3963	3964 - 4269
 Semi-translucent, no leading	A	A	A	A	A	257	291
 Semi-translucent, diamond leading	-	B	B	B	B	418	502
 Semi-translucent, square leading	-	C	C	C	C	418	502
 Smoked, no leading	D	D	-	D	D	257	291
 Smoked, diamond leading	-	E	-	E	E	418	502
 Smoked, square leading	-	F	-	F	F	418	502
 Imitation black, sunrise	G	-	-	-	-	77	101
 Imitation black, no leading	-	H	H	H	H	257	291
 Imitation black, square leading	-	I	I	I	I	418	502
 Imitation black, diamond leading	-	J	J	J	J	418	502

Please state window code on order.

Please note that doors with windows may have cross bracing or locking rods passing behind the windows depending upon size and gear type.

Options	Single doors	Double doors
	add	add
Factory pre-framed standard single doors	102	-
Steel frame for standard double doors	-	153
Factory pre-framed purpose-made single doors	112	-
Steel frame for purpose-made double doors	-	168
Additional Lock Kit, C-type/ R-type (fitted onto door)	45	-
Retractable plus gear available on 1931, 1981 and 2136 mm high doors up to 2744 mm wide	29	-
Diecast metal handles with matching base plates: brass effect, chrome effect and white	33	33
Door without inside flow-coat	deduct 100	deduct 100

Timber Panel Doors

Surface

Timber doors are supplied untreated and require immediate on-site finishing unless fully finished option specified. Timber is a natural material and therefore Garador cannot guarantee to be able to produce matching timber garage doors.

Please note: panel doors are produced with appearance in mind. This may result in some small gaps which could allow water ingress especially in exposed locations.

Handle

Black handle and base plate as standard, optional handles available. Doors can be supplied undrilled and without handle and locking mechanism for use with electric operator.

Packaging

Supplied with front surface protection as standard.

Stock availability

Timber doors are generally made to order and thus require an approximate lead-time of 4 weeks.

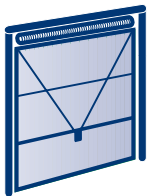

Canopy gearing

Canopy Gearing is available for all single doors providing a reliable and affordable gearing solution, with no tracks running back into the garage.

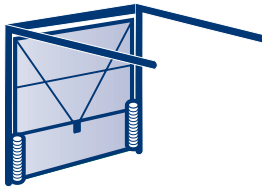



Retractable Gearing

Retractable Gearing is available for all single and double doors providing a reliable and affordable gearing solution, with tracks running back into the garage.

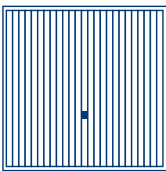
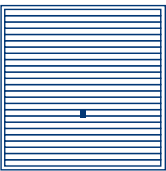
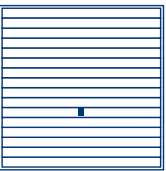
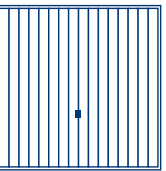
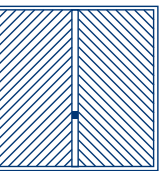
Single door

Size Code	Internal Timber frame opening Width x Height (mm x mm)										
		C	R	C	R	C	R	C	R	C	R
7066	2134 x 1981	1232	1273	1296	1337	1537	1578	1537	1578	1831	1872
7070	2134 x 2136	1242	1283	1306	1347	1551	1592	1551	1592	1861	1902
7076	2134 x 2286	-	1406	-	1478	-	1744	-	1744	-	1965
7566	2259 x 1981	1296	1337	1363	1404	1618	1659	1618	1659	1954	1995
7570	2259 x 2136	1307	1348	1376	1417	1631	1672	1631	1672	1964	2005
7666	2284 x 1981	1296	1337	1493	1534	1618	1659	1618	1659	1954	1995
7670	2284 x 2136	1307	1348	1376	1417	1631	1672	1631	1672	1964	2005
7676	2284 x 2286	-	1460	-	1534	-	1750	-	1750	-	2061
8066	2439 x 1981	1371	1412	1443	1484	1710	1751	1710	1751	2019	2060
8070	2439 x 2136	1382	1423	1453	1494	1724	1765	1724	1765	2030	2071
8076	2439 x 2286	-	1548	-	1625	-	1853	-	1853	-	2116
9066	2744 x 1981	-	1616	-	1698	-	1930	-	1930	-	2251
9070	2744 x 2136	-	1627	-	1709	-	1952	-	1952	-	2284
9076	2744 x 2286	-	1777	-	1866	-	2090	-	2090	-	2359
1066	3049 x 1981	-	1871	-	1964	-	2180	-	2180	-	2530
1070	3049 x 2136	-	1889	-	1984	-	2199	-	2199	-	2548

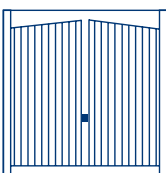
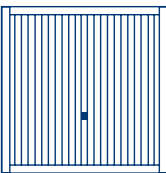
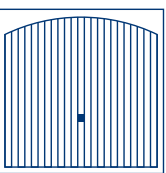
Single door

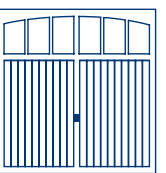
Size Code	Internal Timber frame opening Width x Height (mm x mm)										
		C	R	C	R	C	R	C	R	C	R
7066	2134 x 1981	1563	1604	1551	1592	1409	1450	1831	1872	1853	1894
7070	2134 x 2136	1574	1615	1562	1603	1409	1450	1861	1902	1864	1905
7076	2134 x 2286	-	1743	-	1728	-	1558	-	1965	-	1988
7566	2259 x 1981	1625	1666	1613	1654	1470	1511	1954	1995	1918	1959
7570	2259 x 2136	1636	1677	1624	1665	1470	1511	1964	2005	1929	1970
7666	2284 x 1981	1625	1666	1613	1654	1470	1511	1954	1995	1918	1959
7670	2284 x 2136	1636	1677	1624	1665	1470	1511	1964	2005	1929	1970
7676	2284 x 2286	-	1802	-	1788	-	1627	-	2061	-	2026
8066	2439 x 1981	1682	1723	1669	1710	1618	1659	2019	2060	1980	2021
8070	2439 x 2136	1692	1733	1680	1721	1618	1659	2030	2071	1997	2038
8076	2439 x 2286	-	1853	-	1838	-	1659	-	2116	-	2077
9066	2744 x 1981	-	1920	-	1856	-	1724	-	2251	-	2266
9070	2744 x 2136	-	1936	-	1871	-	1724	-	2284	-	2303
9076	2744 x 2286	-	2089	-	2026	-	1861	-	2359	-	2375
1066	3049 x 1981	-	2173	-	2108	-	1865	-	2530	-	2547
1070	3049 x 2136	-	2191	-	2126	-	1865	-	2548	-	2565

¹ Ashton and Rochdale doors may have cross bracing and/or locking rods behind the windows depending upon the size and gear type.

For further options please see page 39.

Single door

Size Code Internal Timber frame opening Width x Height (mm x mm)

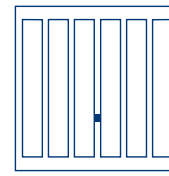
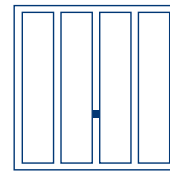
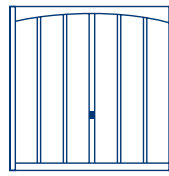
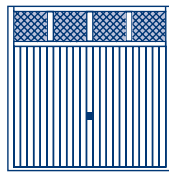

Sandhurst¹

Shaftesbury

Grantham

Seymour

Size Code	Internal Timber frame opening Width x Height (mm x mm)	Sandhurst ¹		Shaftesbury		Grantham		Seymour	
		C	R	C	R	C	R	C	R
7066	2134 x 1981	1795	1836	964	1430	934	975	1327	1368
7070	2134 x 2136	1805	1846	964	1440	934	975	1338	1379
7076	2134 x 2286	-	1929	-	1503	993	1034	-	1442
7566	2259 x 1981	1860	1901	1027	1487	997	1038	1355	1396
7570	2259 x 2136	1871	1912	1027	1498	997	1038	1366	1407
7666	2284 x 1981	1860	1901	1027	1487	997	1038	1355	1396
7670	2284 x 2136	1871	1912	1027	1498	997	1038	1366	1407
7676	2284 x 2286	-	1968	-	1554	1063	1104	-	1463
8066	2439 x 1981	1922	1963	1063	1510	1033	1074	1379	1420
8070	2439 x 2136	1937	1978	1063	1520	1033	1074	1389	1430
8076	2439 x 2286	-	2019	-	1566	-	1145	-	1476
9066	2744 x 1981	-	2178	-	1743	-	1174	-	1668
9070	2744 x 2136	-	2216	-	1757	-	1174	-	1681
9076	2744 x 2286	-	2288	-	1839	-	1256	-	1751
1066	3049 x 1981	-	2459	-	1961	-	1277	-	1882
1070	3049 x 2136	-	2477	-	1979	-	1277	-	1883

¹ Sandhurst doors may have cross bracing and/or locking rods behind the windows depending upon the size and gear type.

Single door

Size Code Internal Timber frame opening Width x Height (mm x mm)

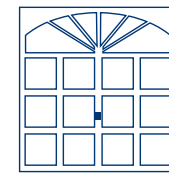
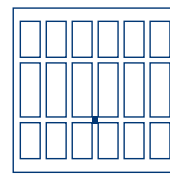
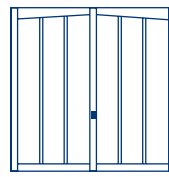
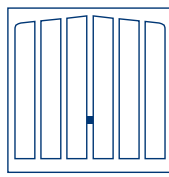

Tudor

Bosworth

Wolsey

Hinton²

Size Code	Internal Timber frame opening Width x Height (mm x mm)	Tudor		Bosworth		Wolsey		Hinton ²	
		C	R	C	R	C	R	C	R
7066	2134 x 1981	1389	1430	1407	1448	1387	1428	1927	1968
7070	2134 x 2136	1399	1440	1417	1458	1397	1438	1938	1979
7076	2134 x 2286	-	1503	-	1521	-	1501	-	2043
7566	2259 x 1981	1416	1457	1435	1476	1414	1455	2047	2088
7570	2259 x 2136	1427	1468	1446	1487	1425	1466	2058	2099
7666	2284 x 1981	1416	1457	1435	1476	1414	1455	2047	2088
7670	2284 x 2136	1427	1468	1446	1487	1425	1466	2058	2099
7676	2284 x 2286	-	1524	-	1543	-	1522	-	2155
8066	2439 x 1981	1440	1481	1458	1499	1438	1479	2108	2149
8070	2439 x 2136	1451	1492	1469	1510	1449	1490	2120	2161
8076	2439 x 2286	-	1537	-	1555	-	1535	-	2205
9066	2744 x 1981	-	1743	-	1762	-	1700	-	2381
9070	2744 x 2136	-	1757	-	1775	-	1713	-	2394
9076	2744 x 2286	-	1839	-	1857	-	1783	-	2473
1066	3049 x 1981	-	1961	-	1979	-	1900	-	2690
1070	3049 x 2136	-	1979	-	1997	-	1902	-	2707

² Hinton doors may have cross bracing and/or locking rods behind the windows depending upon the size and gear type.

For further options please see page 39.

Single door

Internal Timber
frame opening
Width x Height
(mm x mm)

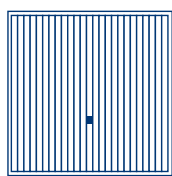

Vertical Cedar

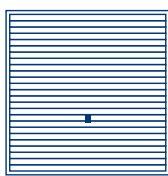

Horizontal Cedar

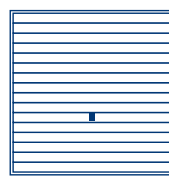

Countryman

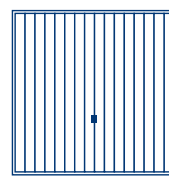

Hampton

		Vertical Cedar		Horizontal Cedar		Countryman		Hampton	
		C	R	C	R	C	R	C	R
1930-1984	x 1931-1981	1339	1380	1408	1449	1876	1917	1876	1917
1930-1984	x 1982-2136	1349	1390	1419	1460	1930	1971	1930	1971
1930-1984	x 2137-2286	-	1511	-	1588	-	2091	-	2091
1930-1984	x 2287-2439	-	1548	-	1625	-	2243	-	2243
1985-2284	x 1931-1981	1402	1443	1474	1515	1978	2019	1978	2019
1985-2284	x 1982-2136	1413	1454	1486	1527	2039	2080	2039	2080
1985-2284	x 2137-2286	-	1564	-	1643	-	2196	-	2196
1985-2284	x 2287-2439	-	1600	-	1680	-	2377	-	2377
2285-2439	x 1931-1981	1476 ¹	1517	1553 ¹	1594 ¹	2005 ¹	2046 ¹	2005 ¹	2046
2285-2439	x 1982-2136	1486 ¹	1527	1563 ¹	1604 ¹	2066 ¹	2107 ¹	2066 ¹	2107
2285-2439	x 2137-2286	-	1650	-	-	-	-	-	-
2285-2439	x 2287-2439	-	1713	-	-	-	-	-	-
2440-2744	x 1931-1981	-	1717	-	-	-	-	-	-
2440-2744	x 1982-2136	-	1728	-	-	-	-	-	-
2440-2744	x 2137-2286	-	1875	-	-	-	-	-	-
2440-2744	x 2287-2439	-	1926	-	-	-	-	-	-
2745-3049	x 1931-1981	-	1966	-	-	-	-	-	-
2745-3049	x 1982-2136	-	1985	-	-	-	-	-	-

¹ These doors are not available over 2438 mm wide.

Single door

Internal Timber
frame opening
Width x Height
(mm x mm)

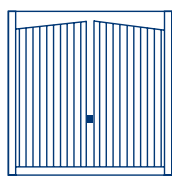

Barrington

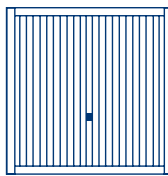

Kingsbury

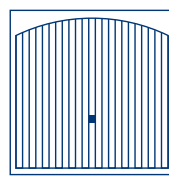

Adlington

		Barrington		Kingsbury		Adlington	
		C	R	C	R	C	R
1930-1984	x 1931-1981	1695	1736	1683	1724	1446	1487
1930-1984	x 1982-2136	1706	1747	1694	1735	1456	1497
1930-1984	x 2137-2286	-	1876	-	1860	-	1618
1930-1984	x 2287-2439	-	1911	-	1902	-	1655
1985-2284	x 1931-1981	1757	1798	1745	1786	1509	1550
1985-2284	x 1982-2136	1768	1809	1756	1797	1520	1561
1985-2284	x 2137-2286	-	1935	-	1920	-	1671
1985-2284	x 2287-2439	-	1971	-	1961	-	1707
2285-2439	x 1931-1981	1814 ¹	1855	1801 ¹	1842	1583 ¹	1624
2285-2439	x 1982-2136	1824 ¹	1865	1812 ¹	1853	1593 ¹	1634
2285-2439	x 2137-2286	-	1986	-	1970	1716	1757
2285-2439	x 2287-2439	-	2036	-	2026	1779	1820
2440-2744	x 1931-1981	-	2053	-	1989	1783	1824
2440-2744	x 1982-2136	-	2068	-	2003	1794	1835
2440-2744	x 2137-2286	-	2222	-	2159	1941	1982
2440-2744	x 2287-2439	-	2273	-	2210	1991	2032
2745-3049	x 1931-1981	-	2305	-	2240	2032	2073
2745-3049	x 1982-2136	-	2324	-	2258	2050	2091

¹ These doors are not available over 2438 mm wide.

For further options please see page 39.

Single door

Internal Timber
frame opening
Width x Height
(mm x mm)



Shaftesbury

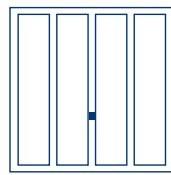

Grantham

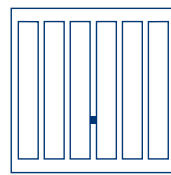

Seymour

		Shaftesbury		Grantham		Seymour	
		C	R	C	R	C	R
1930-1984	x 1931-1981	1459	1500	1225	1266	1459	1500
1930-1984	x 1982-2136	1470	1511	1236	1277	1470	1511
1930-1984	x 2137-2286	-	1574	-	1340	-	1574
1930-1984	x 2287-2439	-	1623	-	1389	-	1623
1985-2284	x 1931-1981	1488	1529	1253	1294	1488	1529
1985-2284	x 1982-2136	1499	1540	1265	1306	1499	1540
1985-2284	x 2137-2286	-	1596	-	1362	-	1596
1985-2284	x 2287-2439	-	1644	-	1409	-	1644
2285-2439	x 1931-1981	1511 ¹	1552	1277 ¹	1318	1511 ¹	1552
2285-2439	x 1982-2136	1521 ¹	1562	1287 ¹	1328	1521 ¹	1562
2285-2439	x 2137-2286	-	1608	-	1374	-	1608
2285-2439	x 2287-2439	-	1677	-	1443	-	1677
2440-2744	x 1931-1981	-	1800	-	1566	-	1800
2440-2744	x 1982-2136	-	1814	-	1579	-	1814
2440-2744	x 2137-2286	-	1884	-	1650	-	1884
2440-2744	x 2287-2439	-	1935	-	1701	-	1935
2745-3049	x 1931-1981	-	2014	-	1780	-	2014
2745-3049	x 1982-2136	-	2015	-	1781	-	2015

¹ These doors are not available over 2438 mm wide.

Single door

Internal Timber
frame opening
Width x Height
(mm x mm)

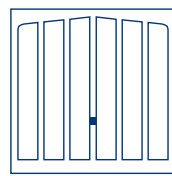

Tudor

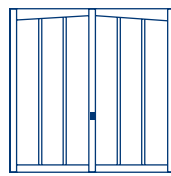

Bosworth

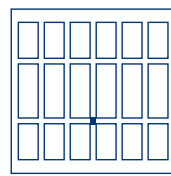

Wolsey

		Tudor		Bosworth		Wolsey	
		C	R	C	R	C	R
1930-1984	x 1931-1981	1521	1562	1539	1580	1519	1560
1930-1984	x 1982-2136	1531	1572	1550	1591	1529	1570
1930-1984	x 2137-2286	-	1635	-	1654	-	1633
1930-1984	x 2287-2439	-	1684	-	1703	-	1688
1985-2284	x 1931-1981	1549	1590	1567	1608	1547	1588
1985-2284	x 1982-2136	1560	1601	1578	1619	1558	1599
1985-2284	x 2137-2286	-	1657	-	1675	-	1655
1985-2284	x 2287-2439	-	1706	-	1724	-	1710
2285-2439	x 1931-1981	1572 ¹	1613	1590 ¹	1631	1570 ¹	1611
2285-2439	x 1982-2136	1583 ¹	1624	1602 ¹	1643	1581 ¹	1622
2285-2439	x 2137-2286	-	1669	-	1687	-	1667
2285-2439	x 2287-2439	-	1763	-	1781	-	1742
2440-2744	x 1931-1981	-	1876	-	1894	-	1832
2440-2744	x 1982-2136	-	1889	-	1907	-	1845
2440-2744	x 2137-2286	-	1971	-	1990	-	1915
2440-2744	x 2287-2439	-	2022	-	2041	-	1966
2745-3049	x 1931-1981	-	2094	-	2112	-	2032
2745-3049	x 1982-2136	-	2112	-	2129	-	2034



¹ These doors are not available over 2438 mm wide.

For further options please see page 39.

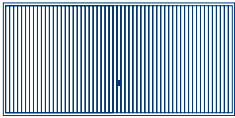
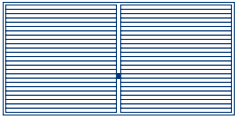
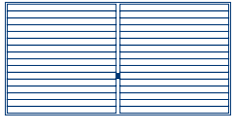
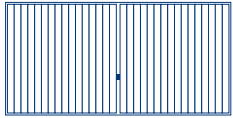
Double door

Size Code	Internal Timber frame opening Width x Height (mm x mm)				
		Vertical Cedar	Horizontal Cedar	Countryman	Hampton
		R	R	R	R
1076	3049 x 2286	2125	2154	2751	2751
1166	3354 x 1981	2125	2155	2722	2722
1170	3354 x 2136	2185	2215	2781	2781
1176	3354 x 2286	2362	2394	3017	3017
1266	3659 x 1981	2395	2427	3031	3031
1270	3659 x 2136	2455	2486	3091	3091
1276	3659 x 2286	2673	2708	3375	3375
1366	3964 x 1981	2832	2871	3341	3341
1370	3964 x 2136	2921	2961	3431	3431
1376	3964 x 2286	3170	3213	3731	3731
1466	4269 x 1981	2771	2811	3441	3441
1470	4269 x 2136	2832	2871	3501	3501
1566	4574 x 1981	3128	3171	-	-
1570	4574 x 2136	3218	3260	-	-
1666	4879 x 1981	3413	3458	-	-
1670	4879 x 2136	3442	3487	-	-

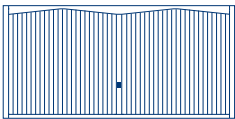
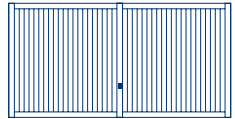
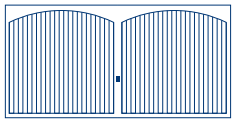
Double door

Size Code	Internal Timber frame opening Width x Height (mm x mm)				
		Barrington	Kingsbury	Adlington	Ashton ¹
		R	R	R	R
1076	3049 x 2286	2529	2410	2359	2808
1166	3354 x 1981	2509	2404	2314	2724
1170	3354 x 2136	2569	2464	2373	2784
1176	3354 x 2286	2784	2670	2571	3020
1266	3659 x 1981	2793	2688	2563	3131
1270	3659 x 2136	2853	2748	2622	3191
1276	3659 x 2286	3114	3012	2859	3484
1366	3964 x 1981	3251	3182	3104	3672
1370	3964 x 2136	3341	3271	3194	3763
1376	3964 x 2286	3631	3556	3472	4095
1466	4269 x 1981	3191	3122	3044	3613
1470	4269 x 2136	3251	3182	3104	3672
1566	4574 x 1981	3547	3502	-	3981
1570	4574 x 2136	3637	3592	-	4070
1666	4879 x 1981	3831	3786	-	4311
1670	4879 x 2136	3862	3817	-	4340

¹ Ashton doors may have cross bracing and/or locking rods behind the windows depending upon the size and gear type.

For further options please see page 39.

Double door

Size Internal Timber
Code frame opening
Width x Height
(mm x mm)

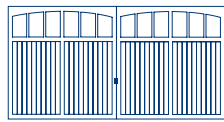

Rochdale^{1,2}

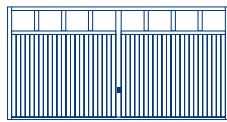

Sandhurst¹

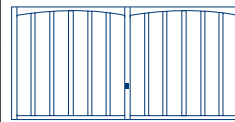

Shaftesbury

		R	R	R
1076	3049 x 2286	2972	2611	2051
1166	3354 x 1981	2873	2595	2026
1170	3354 x 2136	2933	2655	2086
1176	3354 x 2286	3185	2879	2254
1266	3659 x 1981	3280	2927	2248
1270	3659 x 2136	3341	2987	2308
1276	3659 x 2286	3649	3260	2512
1366	3964 x 1981	3822	3416	2620
1370	3964 x 2136	3913	3505	2709
1376	3964 x 2286	4257	3814	2933
1466	4269 x 1981	3763	3356	2560
1470	4269 x 2136	3822	3416	2620
1566	4574 x 1981	4260	3817	2933
1570	4574 x 2136	4349	3907	3023
1666	4879 x 1981	4550	4235	3263
1670	4879 x 2136	4579	4266	3293

¹ Rochdale and Sandhurst doors may have cross bracing and/or locking rods behind the windows depending upon the size and gear type.

² Rochdale doors up to 3659 mm wide will be manufactured with one arch not the two as shown above.

Double door

Size Internal Timber
Code frame opening
Width x Height
(mm x mm)

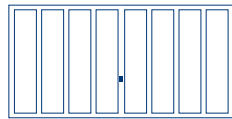

Grantham

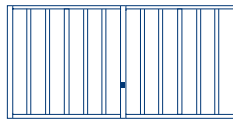

Seymour

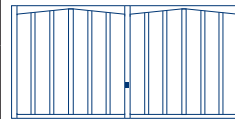

Tudor



Wolsey



		R	R	R	R
1076	3049 x 2286	1796	2031	2051	2305
1166	3354 x 1981	1758	1967	2026	2281
1170	3354 x 2136	1818	2026	2086	2341
1176	3354 x 2286	1958	2188	2254	2509
1266	3659 x 1981	1988	2219	2248	2503
1270	3659 x 2136	2048	2278	2308	2563
1276	3659 x 2286	2224	2481	2512	2766
1366	3964 x 1981	2224	2589	2620	2874
1370	3964 x 2136	2314	2679	2709	2964
1376	3964 x 2286	2500	2904	2933	3188
1466	4269 x 1981	2165	2529	2560	2814
1470	4269 x 2136	2224	2589	2620	2874
1566	4574 x 1981	-	-	2933	3188
1570	4574 x 2136	-	-	3023	3277
1666	4879 x 1981	-	-	3263	3518
1670	4879 x 2136	-	-	3293	3547

For further options please see page 39.

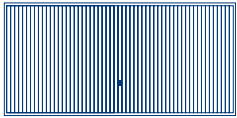
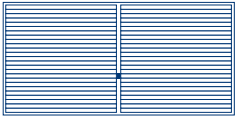
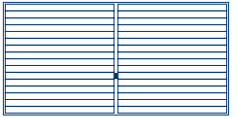
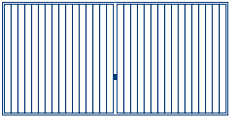
Double door

Internal Timber frame opening Width x Height (mm x mm)				
	Vertical Cedar	Horizontal Cedar	Countryman	Hampton
	R	R	R	R
2745-3049 x 2137-2286	2338	2369	2933	2933
2745-3049 x 2287-2439	2455	2487	3081	3081
3050-3659 x 1931-1981	2634	2670	3234	3234
3050-3659 x 1982-2136	2700	2736	3299	3299
3050-3659 x 2137-2286	2940	2979	3602	3602
3050-3659 x 2287-2439	3087	3129	3782	3782
3660-4269 x 1931-1981	3213	3257	3832	3832
3660-4269 x 1982-2136	3312	3356	3931	3931
3660-4269 x 2137-2286	3478	3524	4127	4127
3660-4269 x 2287-2439	3644	3692	4325	4325
4270-5000 x 1931-1981	3754	3803	-	-
4270-5000 x 1982-2136	3786	3836	-	-

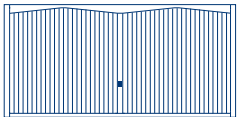
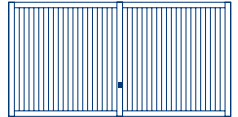
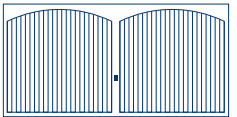
Double door

Internal Timber frame opening Width x Height (mm x mm)				
	Barrington	Kingsbury	Adlington	Ashton ¹
	R	R	R	R
2745-3049 x 2137-2286	2783	2650	2594	3088
2745-3049 x 2287-2439	2921	2784	2725	3243
3050-3659 x 1931-1981	3072	2957	2818	3444
3050-3659 x 1982-2136	3138	3023	2884	3510
3050-3659 x 2137-2286	3424	3312	3144	3832
3050-3659 x 2287-2439	3596	3478	3302	4025
3660-4269 x 1931-1981	3674	3599	3514	4139
3660-4269 x 1982-2136	3773	3698	3612	4237
3660-4269 x 2137-2286	3962	3882	3793	4449
3660-4269 x 2287-2439	4151	4067	3973	4661
4270-5000 x 1931-1981	4215	4165	-	4741
4270-5000 x 1982-2136	4248	4198	-	4774

¹ Ashton doors may have cross bracing and/or locking rods behind the windows depending upon the size and gear type.

For further options please see page 39.

Double door

Internal Timber
frame opening
Width x Height
(mm x mm)

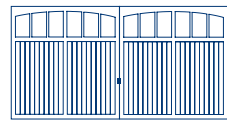

Rochdale ^{1,2}

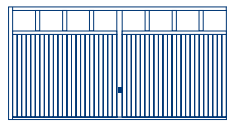

Sandhurst ¹

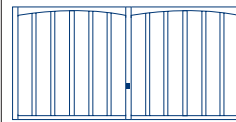

Shaftesbury

		R	R	R
2745-3049	x 2137-2286	3269	2871	2255
2745-3049	x 2287-2439	3433	3015	2368
3050-3659	x 1931-1981	3608	3220	2473
3050-3659	x 1982-2136	3674	3287	2538
3050-3659	x 2137-2286	4013	3586	2762
3050-3659	x 2287-2439	4214	3765	2901
3660-4269	x 1931-1981	4304	3856	2980
3660-4269	x 1982-2136	4402	3954	3079
3660-4269	x 2137-2286	4622	4152	3233
3660-4269	x 2287-2439	4842	4349	3386
4270-5000	x 1931-1981	5005	4659	3589
4270-5000	x 1982-2136	5038	4691	3622

¹ Rochdale and Sandhurst doors may have cross bracing and/or locking rods behind the windows depending upon the size and gear type.

² Rochdale doors up to 3659 mm wide will be manufactured with one arch not the two as shown above.

Double door

Internal Timber
frame opening
Width x Height
(mm x mm)

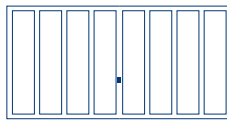

Grantham

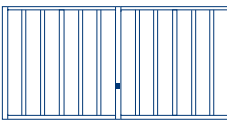

Seymour

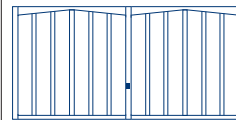



Tudor



Wolsey

		R	R	R	R
2745-3049	x 2137-2286	1975	2235	2255	2510
2745-3049	x 2287-2439	2074	2347	2368	2623
3050-3659	x 1931-1981	2186	2440	2473	2728
3050-3659	x 1982-2136	2252	2506	2538	2793
3050-3659	x 2137-2286	2447	2730	2762	3017
3050-3659	x 2287-2439	2569	2866	2901	3155
3660-4269	x 1931-1981	2545	2947	2980	3235
3660-4269	x 1982-2136	2644	3045	3079	3333
3660-4269	x 2137-2286	2777	3198	3233	3487
3660-4269	x 2287-2439	2909	3351	3386	3641
4270-5000	x 1931-1981	-	-	3589	3843
4270-5000	x 1982-2136	-	-	3622	3876

For further options please see page 39.

Timber door window options						
	Standard		Georgian ¹		Diagonal ¹	
	Single doors	Double doors	Single doors	Double doors	Single doors	Double doors
Prices in £ stated per door						
Plain	no on-cost	no on-cost	91	126	91	126
Crystal	no on-cost	no on-cost	91	126	91	126

¹ Only available on Sandhurst.

Windows are manufactured from 4 mm acrylic panes. Please state on order if clear or stippled panes required.

Options	Single doors	Double doors
	add	add
Factory pre-framed standard single doors	102	-
Steel frame for standard double doors	-	153
Factory pre-framed purpose-made single doors	112	-
Steel frame for purpose-made double doors	-	168
Additional Lock Kit, C-type/ R-type (fitted onto door)	45	-
Retractable plus gear available on 1931, 1981 and 2136 mm high doors up to 2744 mm wide	29	-
Factory fully finished stain in Light Oak, Antique Oak, Mahogany, Walnut, Chestnut and Ebony	109	163
Factory white primer ready for on-site painting	148	229
Factory fully finished painting (any RAL colour)	249	433
Diecast metal handles with matching base plates: brass effect, chrome effect and white	33	33
Bottom weatherseal, 2405 mm length (suitable for gaps up to 15 mm between the door and the floor level)	29	29
Bottom weatherseal, 3000 mm length (suitable for gaps up to 15 mm between the door and the floor level)	33	33
Steel chassis and frame if applicable finished in RAL colour (Moss Green (RAL 6005), Ruby Red (RAL 3003), Signal Blue (RAL 5005), Jet Black (RAL 9005), Steel Blue (RAL 5011), Light Ivory (RAL 1015), Pigeon Blue (RAL 5014), Fir Green (RAL 6009), Anthracite Grey (RAL 7016), Stone Grey (RAL 7030), Light Grey (RAL 7035), Ochre Brown (RAL 8001), Clay Brown (RAL 8003), White Aluminium (RAL 9006), Grey Aluminium (RAL 9007) and Window Grey (RAL 7040). Additional lead time may apply.	99	156

Steel and Timber Garage Side Doors

Surface

Steel doors constructed around a strong steel box section chassis in Traffic White (RAL 9016) as standard. Timber doors constructed using solid red cedar, built around a strong steel box section chassis. A range of stain options are available.





Stock Availability

Four to six week week lead time on standard and purpose made sizes.

Handle

Supplied with lever/ lever handle on left side (viewed outside)

Steel door - standard sizes





Size Code	Internal frame opening Width x Height (mm x mm)	Overall frame size (between fix) ¹ Width x Height (mm x mm)	 Georgian	 Beaumont	 Cathedral	 Beaumont with Windows ²	 Carlton
2664	762 x 1931	882 x 1989	525 ³	525 ³	525 ³	588 ³	415
2666	762 x 1981	882 x 2039	536 ³	536 ³	536 ³	599 ³	427
2670	762 x 2136	882 x 2194	552 ³	552 ³	552 ³	615 ³	443
3064	914 x 1931	1034 x 1989	546 ³	546 ³	546 ³	609 ³	437
3066	914 x 1981	1034 x 2039	557 ³	557 ³	557 ³	620 ³	448
3070	914 x 2136	1034 x 2194	575 ³	575 ³	575 ³	638 ³	465
3664	1067 x 1931	1187 x 1989	568	568	568	632	459
3666	1067 x 1981	1187 x 2039	580	580	580	643	471
3670	1067 x 2134	1187 x 2194	596	596	596	659	487
4064	1209 x 1931	1320 x 1989	590	590	590	653	481
4066	1209 x 1981	1320 x 2039	601	601	601	664	492
4070	1209 x 2136	1320 x 2194	606	606	606	669	508

¹ No fitting clearance allowed.

² Windows for Beaumont: Standard () , Diamond () , Cross () . Please state on order if plain or crystal panes.

³ Doors under 1000 mm width only have one vertical column of pressings. These doors vary from images shown.

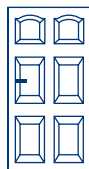
Steel door - purpose-made sizes

Internal frame opening Width x Height (mm x mm)	Overall frame size (between fix) ¹ Width x Height (mm x mm)	 Georgian	 Beaumont	 Cathedral	 Beaumont with Windows ²	 Carlton
700-1066 x 1931-2136	820-1186 x 1989-2194	677 ⁴	677 ⁴	677 ⁴	741 ⁴	580
2067-1209 x 1931-2136	1187-1320 x 1989-2194	720	720	720	784	622





¹ No fitting clearance allowed.

² Windows for Beaumont: Standard () , Diamond () , Cross () . Please state on order if plain or crystal panes.

⁴ Only available from 755 mm wide. Overall frame size is 875 mm wide for Cathedral, Beaumont and Georgian only.

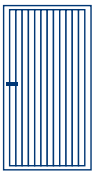

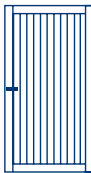
All doors come factory pre-framed, right hand hinged with the handle on the left as standard (viewed from outside). Supplied with lever / lever handle set. Doors only available to open outwards.

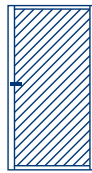
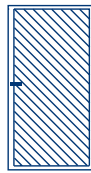
**Timber door -
standard sizes**

Size Code	Internal frame opening Width x Height (mm x mm)	Overall frame size (between fix) ¹ Width x Height (mm x mm)	 Vertical Cedar	 Horizontal Cedar	 Kingsbury	 Seymour	 Half Chevron (Left)	 Half Chevron (Right)
2664	762 x 1931	882 x 1989	952	974	1033	952	1140	1140
2666	762 x 1981	882 x 2039	963	984	1043	963	1150	1150
2670	762 x 2136	882 x 2194	979	1000	1059	979	1166	1166
3064	914 x 1931	1034 x 1989	984	1005	1064	984	1171	1171
3066	914 x 1981	1034 x 2039	995	1016	1076	995	1182	1182
3070	914 x 2136	1034 x 2194	1011	1033	1091	1011	1198	1198
3664	1067 x 1931	1187 x 1989	1016	1038	1097	1016	1204	1204
3666	1067 x 1981	1187 x 2039	1027	1048	1107	1027	1214	1214
3670	1067 x 2134	1187 x 2194	1043	1064	1123	1043	1230	1230
4064	1209 x 1931	1320 x 1989	1048	1069	1128	1048	1235	1235
4066	1209 x 1981	1320 x 2039	1059	1081	1140	1059	1247	1247
4070	1209 x 2136	1320 x 2194	1076	1097	1155	1076	1262	1262

¹ No fitting clearance allowed.

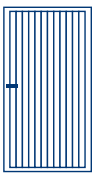
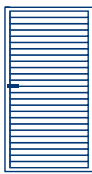
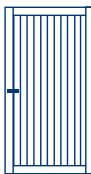
**Timber door -
purpose-made sizes**

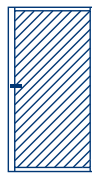
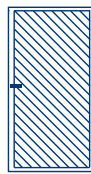
Internal frame opening Width x Height (mm x mm)	Overall frame size (between fix) ¹ Width x Height (mm x mm)	 Vertical Cedar	 Horizontal Cedar	 Kingsbury ²	 Seymour	 Half Chevron (Left)	 Half Chevron (Right)
700-1066 x 1931-2136	820-1186 x 1989-2194	1150	1171	1230	1150	1337	1337
2067-1209 x 1931-2136	1187-1320 x 1989-2194	1214	1235	1294	1214	1401	1401

¹ No fitting clearance allowed.

² Minimum overall frame width for Kingsbury is 826 mm.

Options for garage side doors	add
For powder-coated steel doors ¹ : Terra Brown (RAL 8028)	21
For powder-coated steel doors ¹ : Moss Green (RAL 6005), Ruby Red (RAL 3003), Signal Blue (RAL 5005), Jet Black (RAL 9005), Steel Blue (RAL 5011), Light Ivory (RAL 1015), Pigeon Blue (RAL 5014), Fir Green (RAL 6009), Anthracite Grey (RAL 7016), Stone Grey (RAL 7030), Light Grey (RAL 7035), Ochre Brown (RAL 8001), Clay Brown (RAL 8003), White Aluminium (RAL 9006), Grey Aluminium (RAL 9007) and Window Grey (RAL 7040)	71
Handles for steel doors: knob/lever black plastic	21
For timber doors: factory fully finishing in Light Oak, Antique Oak, Mahogany, Walnut, Chestnut and Ebony	71
Factory white primer ready for on-site painting	120
Factory fully finished painting (any RAL colour)	200
Anodised Aluminium lever/lever handles: white	92
Anodised Aluminium lever/lever handles: chrome effect	117
Left hand hinged	66
For steel doors: poly-wrapping (free of charge on colour doors)	18

¹ Coloured Beaumont with windows door is supplied with white or brown window frames as standard (for colour window frames see page 15).

Steel and Timber Side-hinged Doors

Surface

Steel Side-hinged doors are constructed around a strong steel box section chassis in Traffic White (RAL 9016) as standard. Timber doors constructed using solid red cedar, built around our steel box section chassis. A range of stain options are available.

Stock Availability

Four to six week lead time on standard and purpose made sizes.

Handle

Supplied with black lever/ lever handle on right side (viewed outside)

Packaging

All steel side-hinged doors are poly-wrapped as standard.

Steel door - standard sizes

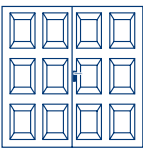
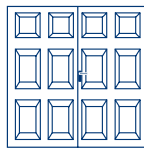
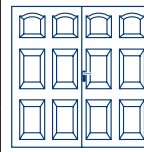
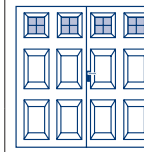
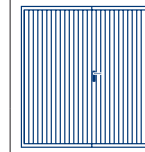
Size Code	Internal frame opening Width x Height (mm x mm)	Overall frame size (between fix) ¹ Width x Height (mm x mm)	    				
			Georgian	Beaumont	Cathedral	Beaumont with Windows ²	Carlton
6060	1810 x 1830	1930 x 1890	-	-	-	-	885
6660	1964 x 1830	2084 x 1890	-	-	-	-	902
6664	1964 x 1931	2084 x 1991	-	-	-	-	921
6666	1964 x 1981	2084 x 2041	-	-	-	-	921
6670	1964 x 2136	2084 x 2196	-	-	-	-	941
7060	2114 x 1830	2234 x 1890	-	-	-	-	941
7064	2114 x 1931	2234 x 1991	1032	1032	1032	1279	958
7066	2114 x 1981	2234 x 2041	1032	1032	1032	1279	958
7070	2114 x 2136	2234 x 2196	1051	1051	1051	1297	978
7564	2239 x 1931	2359 x 1991	1089	1089	1089	1337	1016
7566	2239 x 1981	2359 x 2041	1089	1089	1089	1337	1016
7570	2239 x 2136	2359 x 2196	1109	1109	1109	1357	1032
7664	2264 x 1931	2384 x 1991	1109	1109	1109	1357	1032
7666	2264 x 1981	2384 x 2041	1109	1109	1109	1357	1032
7670	2264 x 2136	2384 x 2196	1126	1126	1126	1373	1051
8064	2419 x 1931	2539 x 1991	1165	1165	1165	1412	1089
8066	2419 x 1981	2539 x 2041	1165	1165	1165	1412	1089
8070	2419 x 2136	2539 x 2196	1183	1183	1183	1431	1109

¹ No fitting clearance allowed.

² Windows for Beaumont: Standard () , Diamond () , Cross () . Please state on order if plain or crystal panes.

All doors come factory pre-framed, right hand door leaf leading as standard (viewed from the outside) with lever / lever handle set.

Door stays are recommended in windy locations.

The above doors are shown as 50/50 door leaves configuration.

Up to 2234 mm overall frame width these doors are also available as a 1/3 2/3 door configuration.

Prices are the same but please be aware panel configurations on Georgian, Beaumont & Cathedral doors will have 3 pressing columns with increased spacing between the pressing (1/3 2/3 is a term used to describe these doors but please note the 1/3 door leaf is always 800 mm wide with the 2/3 element varying to make the desired overall width). 1/3 leaf is always leading.

**Steel door -
purpose-made sizes**

Overall frame size
(between fix) ¹
Width x Height
(mm x mm)

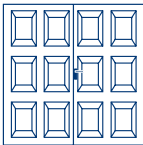
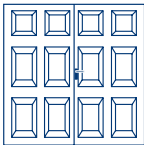
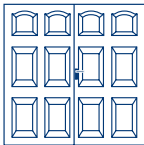
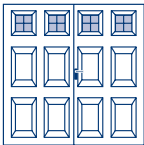
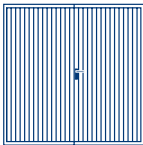
					
	Georgian	Beaumont	Cathedral	Beaumont with Windows ²	Carlton
1930 - 2234 x 1890 - 2041	-	-	-	-	1026
1930 - 2234 x 2042 - 2196	-	-	-	-	1057
2235 - 2384 x 1890 - 2041	-	-	-	-	1071
2235 - 2384 x 1991 - 2041	1174	1174	1174	1422	1109
2235 - 2384 x 2042 - 2196	1187	1187	1187	1435	1133
2385 - 2539 x 1890 - 2041	-	-	-	-	1123
2385 - 2539 x 1991 - 2041	1249	1249	1249	1495	1173
2385 - 2539 x 2042 - 2196	1266	1266	1266	1513	1189

¹ No fitting clearance allowed.

² Windows for Beaumont: Standard () , Diamond () , Cross () . Please state on order if plain or crystal panes.

All doors come factory pre-framed, right hand door leaf leading as standard (viewed from the outside) with lever / lever handle set.

Door stays are recommended in windy locations.

The above doors are shown as 50/50 door leaves configuration.

Up to 2234 mm overall frame width these doors are also available as a 1/3 2/3 door configuration.

Prices are the same but please be aware panel configurations on Georgian, Beaumont & Cathedral doors will have 3 pressing columns with increased spacing between the pressing (1/3 2/3 is a term used to describe these doors but please note the 1/3 door leaf is always 800 mm wide with the 2/3 element varying to make the desired overall width). 1/3 leaf is always leading.

Timber door - standard sizes

Size Code	Internal frame opening Width x Height (mm x mm)	Overall frame size (between fix) ¹ Width x Height (mm x mm)					
			Vertical Cedar ²	Horizontal Cedar ²	Kingsbury	Seymour	Tudor
6060	1810 x 1830	1930 x 1890	1476	1510	1668	1390	1390
6660	1964 x 1830	2084 x 1890	1497	1532	1668	1411	1411
6664	1964 x 1931	2084 x 1991	1497	1532	1668	1411	1411
6666	1964 x 1981	2084 x 2041	1513	1548	1674	1428	1428
6670	1964 x 2136	2084 x 2196	1513	1548	1695	1428	1428
7060	2114 x 1830	2234 x 1890	1540	1574	1695	1454	1454
7064	2114 x 1931	2234 x 1991	1546	1579	1711	1460	1460
7066	2114 x 1981	2234 x 2041	1551	1586	1732	1465	1465
7070	2114 x 2136	2234 x 2196	1551	1586	1743	1465	1465
7564	2239 x 1931	2359 x 1991	1567	1601	1802	1482	1482
7566	2239 x 1981	2359 x 2041	1572	1607	1813	1487	1487
7570	2239 x 2136	2359 x 2196	1582	1617	1850	1497	1497
7664	2264 x 1931	2384 x 1991	1567	1601	1807	1482	1482
7666	2264 x 1981	2384 x 2041	1572	1607	1834	1487	1487
7670	2264 x 2136	2384 x 2196	1582	1617	1872	1497	1497
8064	2419 x 1931	2539 x 1991	1636	1671	1989	1551	1551
8066	2419 x 1981	2539 x 2041	1642	1676	2000	1556	1556
8070	2419 x 2136	2539 x 2196	1647	1681	2059	1561	1561

¹ No fitting clearance allowed.



² The above doors are shown as 50/50 door leaves configuration. Up to 2234 mm overall frame width these doors are also available as a 1/3 2/3 door configuration on Vertical Cedar and Horizontal Cedar doors.

Prices are the same but please be aware panel configurations may be different from those shown above (1/3 2/3 is a term used to describe these doors but please note the 1/3 door leaf is always 800 mm wide with the 2/3 element varying to make the desired overall width). 1/3 leaf is always leading.

All doors come factory pre-framed, right hand door leaf leading as standard (viewed from the outside) with lever / lever handle set.

Door stays are recommended in windy locations.

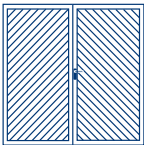
**Timber door -
standard sizes**

Size Code	Internal frame opening Width x Height (mm x mm)	Overall frame size (between fix) ¹ Width x Height (mm x mm)	 Chevron Cedar	 Ashton ³	 Ashton Chevron ³
6060	1810 x 1830	1930 x 1890	1668	1807	1898
6660	1964 x 1830	2084 x 1890	1668	1807	1898
6664	1964 x 1931	2084 x 1991	1668	1807	1898
6666	1964 x 1981	2084 x 2041	1674	1813	1903
6670	1964 x 2136	2084 x 2196	1695	1834	1925
7060	2114 x 1830	2234 x 1890	1695	1834	1925
7064	2114 x 1931	2234 x 1991	1711	1850	1941
7066	2114 x 1981	2234 x 2041	1732	1872	1962
7070	2114 x 2136	2234 x 2196	1743	1882	1973
7564	2239 x 1931	2359 x 1991	1802	1941	2031
7566	2239 x 1981	2359 x 2041	1813	1952	2043
7570	2239 x 2136	2359 x 2196	1850	1989	2080
7664	2264 x 1931	2384 x 1991	1807	1946	2038
7666	2264 x 1981	2384 x 2041	1834	1973	2064
7670	2264 x 2136	2384 x 2196	1872	2010	2102
8064	2419 x 1931	2539 x 1991	1989	2128	2219
8066	2419 x 1981	2539 x 2041	2000	2138	2230
8070	2419 x 2136	2539 x 2196	2059	2197	2288

¹ No fitting clearance allowed.

³ On doors with windows, please state on order if plain or crystal panes.

All doors come factory pre-framed, right hand door leaf leading as standard (viewed from the outside) with lever / lever handle set.

Door stays are recommended in windy locations.

Timber door - purpose-made sizes

Overall frame size
(between fix)¹
Width x Height
(mm x mm)

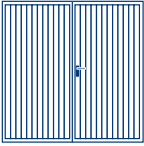
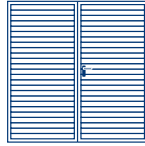
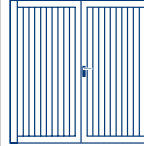
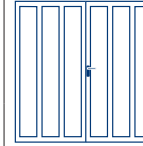
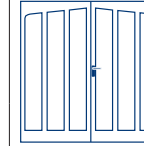

	 Vertical Cedar ²	 Horizontal Cedar ²	 Kingsbury	 Seymour	 Tudor
1930 - 2234 x 1890 - 2041	1581	1617	1764	1502	1502
1930 - 2234 x 2042 - 2196	1617	1654	1801	1539	1539
2235 - 2384 x 1890 - 2041	1654	1691	1838	1575	1575
2235 - 2384 x 2042 - 2196	1701	1738	1980	1623	1623
2385 - 2539 x 1890 - 2041	1801	1838	2085	1722	1722
2385 - 2539 x 2042 - 2196	1833	1869	2117	1754	1754

¹ No fitting clearance allowed.

² On doors with windows, please state on order if plain or crystal panes.

Timber door - purpose-made sizes

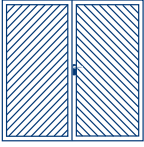
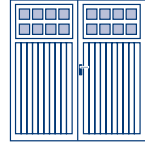
Overall frame size
(between fix)¹
Width x Height
(mm x mm)

	 Chevron Cedar	 Ashton ³	 Ashton Chevron ³
1930 - 2234 x 1890 - 2041	1764	1901	1990
1930 - 2234 x 2042 - 2196	1801	1938	2027
2235 - 2384 x 1890 - 2041	1838	1974	2064
2235 - 2384 x 2042 - 2196	1980	2124	2217
2385 - 2539 x 1890 - 2041	2085	2228	2322
2385 - 2539 x 2042 - 2196	2117	2261	2355

¹ No fitting clearance allowed.

² The above doors are shown as 50/50 door leaves configuration. Up to 2234 mm overall frame width these doors are also available as a 1/3 2/3 door configuration on Vertical Cedar and Horizontal Cedar doors.

Prices are the same but please be aware panel configurations may be different from those shown above (1/3 2/3 is a term used to describe these doors but please note the 1/3 door leaf is always 800 mm wide with the 2/3 element varying to make the desired overall width). 1/3 leaf is always leading.

³ On doors with windows, please state on order if plain or crystal panes.

All doors come factory pre-framed, right hand door leaf leading as standard (viewed from the outside) with lever / lever handle set.

Door stays are recommended in windy locations.

Options for side-hinged doors	add
For powder-coated steel doors ¹ : Terra Brown (RAL 8028)	28
For powder-coated steel doors ¹ : Moss Green (RAL 6005), Ruby Red (RAL 3003), Signal Blue (RAL 5005), Jet Black (RAL 9005), Steel Blue (RAL 5011), Light Ivory (RAL 1015), Pigeon Blue (RAL 5014), Fir Green (RAL 6009), Anthracite Grey (RAL 7016), Stone Grey (RAL 7030), Light Grey (RAL 7035), Ochre Brown (RAL 8001), Clay Brown (RAL 8003), White Aluminium (RAL 9006), Grey Aluminium (RAL 9007) and Window Grey (RAL 7040)	99
Door stays (pair)	56
Handles for steel doors: knob/lever black plastic	21
Handles for timber doors: knob/lever black plastic	21
For timber doors: factory fully finished in Light Oak, Antique Oak, Mahogany, Walnut, Chestnut and Ebony	109
Factory white primer ready for on-site painting	148
Factory fully finished painting (any RAL colour)	250
Anodised Aluminium lever/lever handles: white	92
Anodised Aluminium lever/lever handles: chrome effect	117
Left hand hinged	66

¹ Coloured Beaumont with windows doors are supplied with white or brown window frames as standard (for colour window frames see page 15).

For timber side-hinged doors chassis is either white or brown regardless of exact colour of timber finishing, except when Ebony finishing is ordered and then the chassis will be supplied in black.

Steel Panel Doors - Specifications

Canopy Gear Specifications

The canopy gear allows the door to travel in vertical tracks and is counterbalanced by an overhead torsion spring. The nominal drive through is 40 mm less than the opening width and 130 mm less than the opening height.

In the open position, the door projects approximately one third of the door height, forming a canopy.

For doors fitted with an operator, please respect operator specifications.

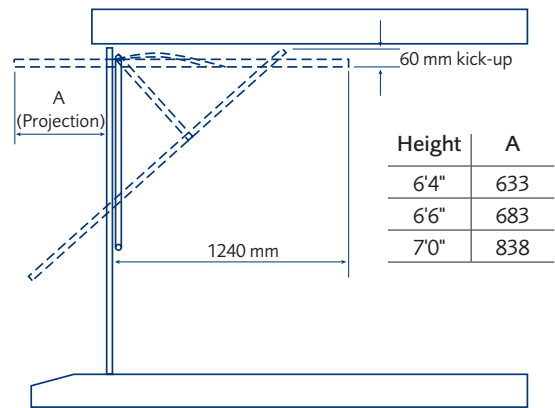

On-site timber frame

Behind brickwork fixing

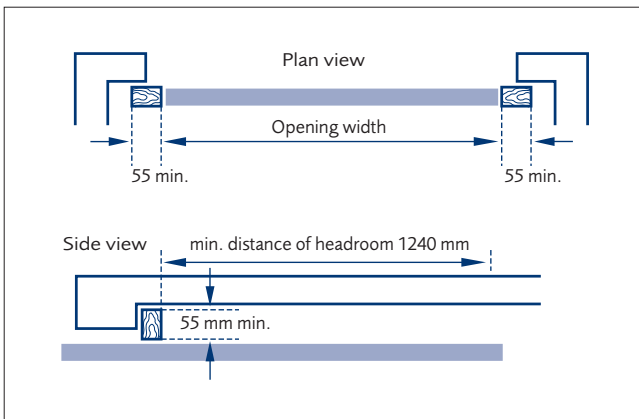

Between brickwork fixing

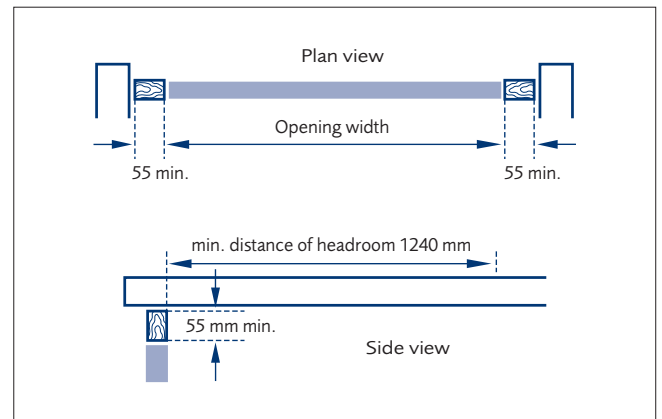

Factory pre-framed with steel box frame

The garage door is supplied factory fitted to a steel box section frame and is secured to the brickwork by using just 7 fixings.

Behind brickwork fixing

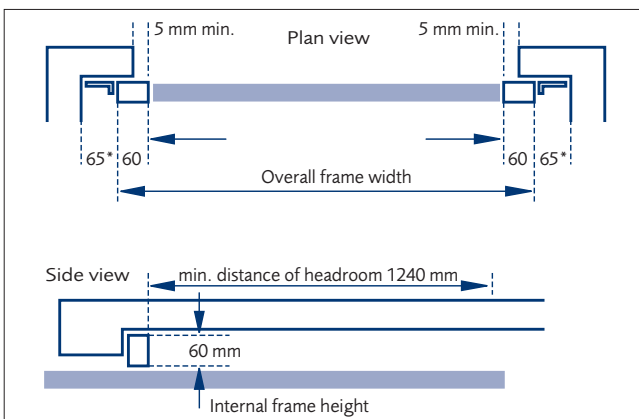

Between brickwork fixing

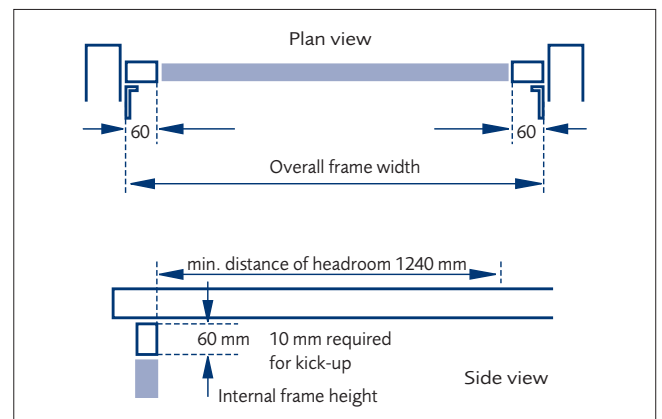

* width of anchor in this position

Single & Double Retractable Gear Specifications

The retractable gear allows the door to be retracted inside the garage when open by means of horizontal overhead tracks supported by wall or ceiling mounted suspension brackets. This gear is available as an option for single doors and comes as standard with double garage doors.

The nominal drive through clearance is 105 mm less than the opening width and 110 mm less than the opening height for single doors and 140 mm less than the opening height for double doors.

For doors fitted with an operator, please respect operator specifications.

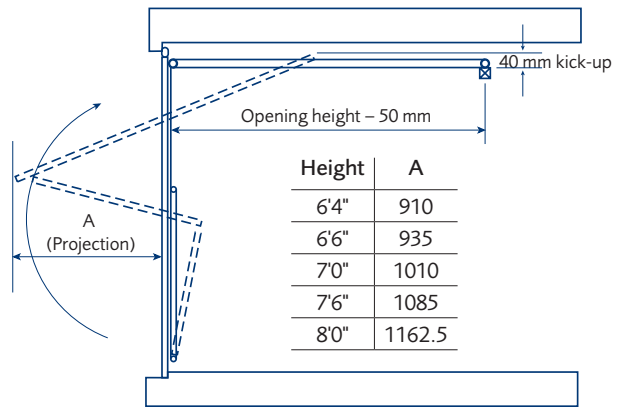

On-site timber frame

Behind brickwork fixing

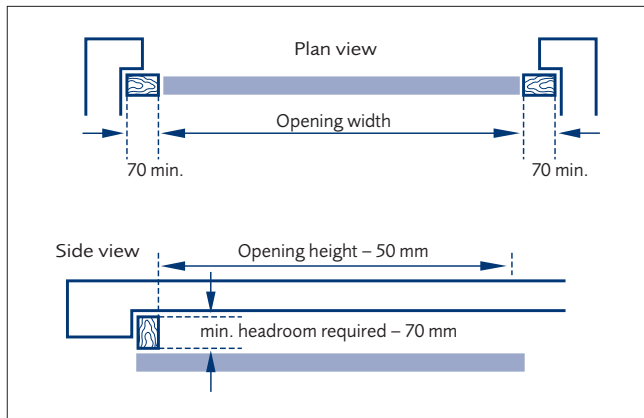

Between brickwork fixing

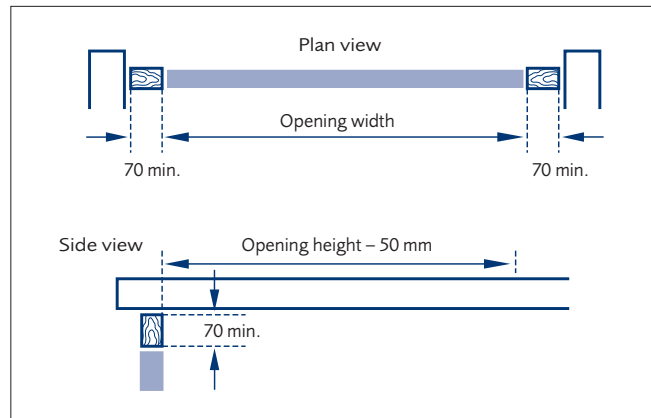

Factory pre-framed with steel box frame

The garage door is supplied factory fitted to a steel box section frame and is secured to the brickwork by using just 7 fixings.

Behind brickwork fixing

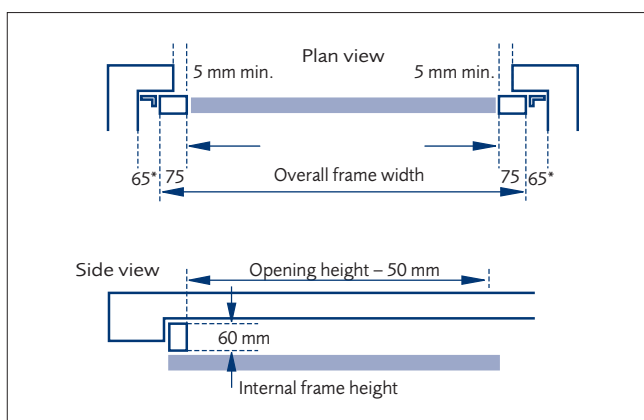

Between brickwork fixing

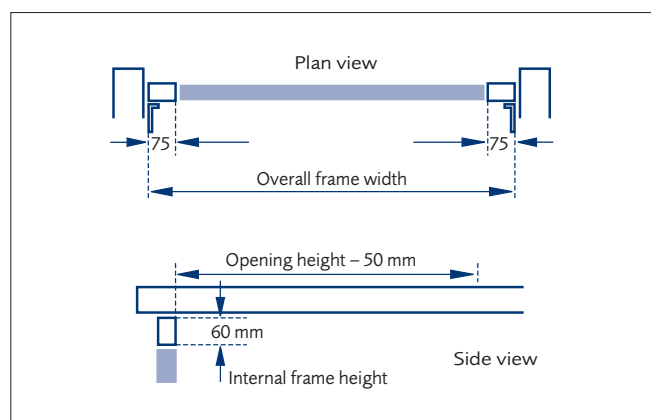

* width of anchor in this position

Retractable Plus Gear

For any door up to a width of 2744 mm in any of the three standard heights Retractable Plus Gear is available. This gear type creates clear drive through width at the crucial wing mirror height.

Door height	Clear height below lifting arms
7'0"	1260
6'6"	1105
6'4"	1055

Garage Side Door & Side-hinged Door Specifications

Door leaves supplied factory pre-framed ready for site installation. Fixed leaf (RH side when viewed from inside) fitted with tower bolts at top and bottom of inner leading edge. The floor will need to be finished and level for the bottom tower bolts to engage.

Side-hinged door factory pre-framed

Behind brickwork fixing

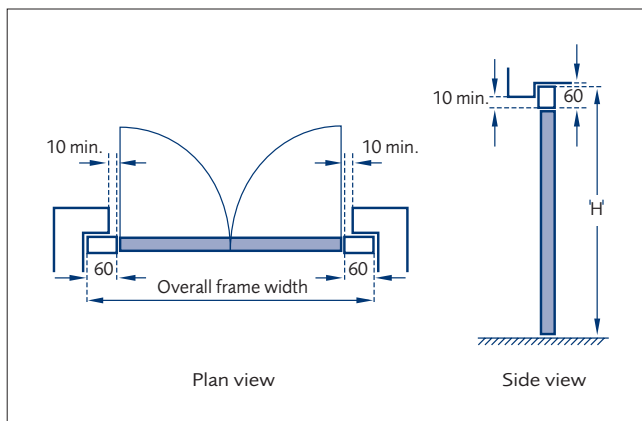

Between brickwork fixing

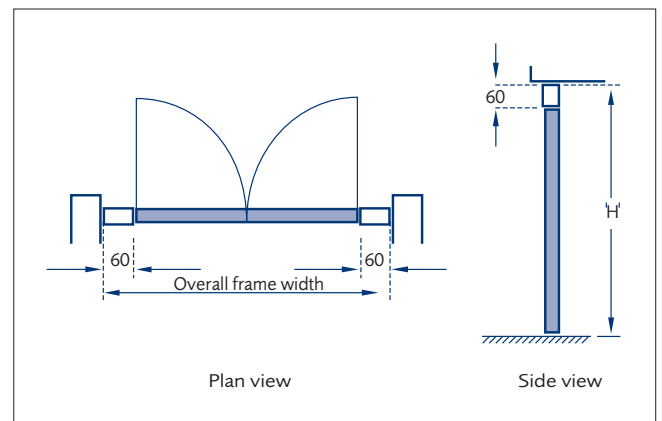

The nominal drive through clearance is 124 mm less than the opening width and 12 mm less than the opening height.

Garage Side door factory pre-framed

Behind brickwork fixing

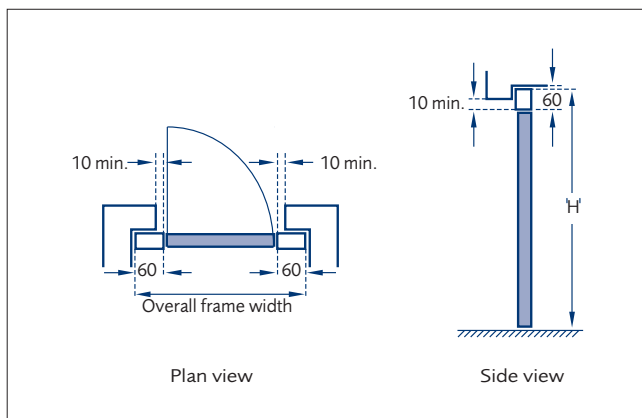

Between brickwork fixing

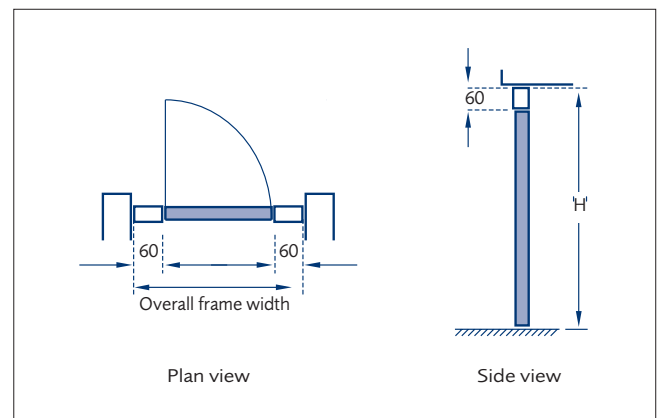

The nominal clear passage clearance is 74 mm less than the opening width and 12 mm less than the opening height.

Frame Dimensions for Panel Doors

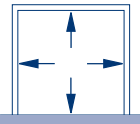
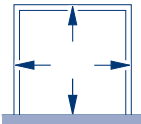
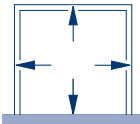
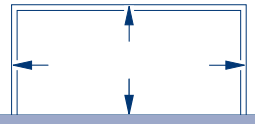
Size Code	 Internal frame size On-site timber frame	 Pre-framed canopy door overall frame sizes shown ¹	 Pre-framed retractable door overall frame sizes shown ¹	 Frame kit for double door overall frame sizes shown ¹
	Width x Height (mm x mm)	Width x Height (mm x mm)	Width x Height (mm x mm)	Width x Height (mm x mm)
6660	1984 x 1830	2094 x 1888	2124 x 1888	-
6663	1984 x 1906	2094 x 1964	2124 x 1964	-
6664	1984 x 1931	2094 x 1989	2124 x 1989	-
6666	1984 x 1981	2094 x 2039	2124 x 2039	-
6670	1984 x 2136	2094 x 2194	2124 x 2194	-
61064	2084 x 1931	2194 x 1989	2224 x 1989	-
61066	2084 x 1981	2194 x 2039	2224 x 2039	-
61070	2084 x 2136	2194 x 2194	2224 x 2194	-
7060	2134 x 1830	2244 x 1888	2274 x 1888	-
7063	2134 x 1905	2244 x 1963	2274 x 1963	-
7064	2134 x 1931	2244 x 1989	2274 x 1989	-
7066	2134 x 1981	2244 x 2039	2274 x 2039	-
7070	2134 x 2136	2244 x 2194	2274 x 2194	-
7076	2134 x 2286	-	2274 x 2344	-
7164	2170 x 1931	2280 x 1989	2310 x 1989	-
7166	2170 x 1981	2280 x 2039	2310 x 2039	-
7170	2170 x 2136	2280 x 2194	2310 x 2194	-
7176	2170 x 2286	-	2310 x 2344	-
7364	2224 x 1931	2334 x 1989	2364 x 1989	-
7366	2224 x 1981	2334 x 2039	2364 x 2039	-
7370	2224 x 2136	2334 x 2194	2364 x 2194	-
7564	2259 x 1931	2369 x 1989	2399 x 1989	-
7566	2259 x 1981	2369 x 2039	2399 x 2039	-
7570	2259 x 2136	2369 x 2194	2399 x 2194	-
7576	2259 x 2286	-	2399 x 2344	-
7664	2284 x 1931	2394 x 1989	2424 x 1989	-
7666	2284 x 1981	2394 x 2039	2424 x 2039	-
7670	2284 x 2136	2394 x 2194	2424 x 2194	-
7676	2284 x 2286	-	2424 x 2344	-
8064	2439 x 1931	2549 x 1989	2579 x 1989	-
8066	2439 x 1981	2549 x 2039	2579 x 2039	-
8070	2439 x 2136	2549 x 2194	2579 x 2194	-
8076	2439 x 2286	-	2579 x 2344	-
8666	2590 x 1981	-	2730 x 2039	-
8670	2590 x 2136	-	2730 x 2194	-
8676	2590 x 2286	-	2730 x 2344	-
9066	2744 x 1981	-	2884 x 2039	-
9070	2744 x 2136	-	2884 x 2194	-
9076	2744 x 2286	-	2884 x 2344	-
1066	3049 x 1981	-	3189 x 2039	-
1070	3049 x 2136	-	3189 x 2194	-
1076	3049 x 2286	-	-	3189 x 2344
1166	3354 x 1981	-	-	3494 x 2039
1170	3354 x 2136	-	-	3494 x 2194
1176	3354 x 2286	-	-	3494 x 2344
1266	3659 x 1981	-	-	3799 x 2039
1270	3659 x 2136	-	-	3799 x 2194
1276	3659 x 2286	-	-	3799 x 2344
1366	3964 x 1981	-	-	4104 x 2039
1370	3964 x 2136	-	-	4104 x 2194
1376	3964 x 2286	-	-	4104 x 2344
1466	4269 x 1981	-	-	4409 x 2039
1470	4269 x 2136	-	-	4409 x 2194
1566	4574 x 1981	-	-	4714 x 2039
1570	4574 x 2136	-	-	4714 x 2194
1666	4879 x 1981	-	-	5019 x 2039
1670	4879 x 2136	-	-	5019 x 2194

¹ No fitting clearance allowed. If door is fitted between the brickwork a minimum of 10 mm clearance over the width and 5 mm over the height should be added to the overall frame size when selecting the door.

Steel Sectional Garage Doors

Door sections

Made of galvanized steel. Available as Premium (42 mm thick insulated panel) and Classic (single skinned panel) versions. Premium doors are PU-foam insulated (100% CFC-free). Bottom door section comes with floor seal.

Surface

Outside: Woodgrain embossed, Sandgrain or Silkgrain textures with painted or foil coated finishes.
Inside: pebble texture.

Spring arrangement

All doors up to 3049 mm wide come with tension springs as standard and torsion springs are available at extra cost. All doors over 3050 mm wide come with torsion springs as standard. Low headroom application available at extra cost.

Side frames & Fascia

Sectional doors are designed to be fitted behind the reveals and side frames are supplied white in colour. Cover profiles are available for use with coloured or foil coated door finishes. A single skin fascia is supplied with all doors which is finished in the same colour as the door sections.

Colours

Steel Woodgrain and Silkgrain doors can be ordered in almost any colour from the RAL colour chart.

Standard colours are:

- | | | | |
|--------------------------|------------------------------|--------------------------|------------------------------|
| - Light Ivory (RAL 1015) | - Moss Green (RAL 6005) | - Light Grey (RAL 7035) | - Terra Brown (RAL 8028) |
| - Ruby Red (RAL 3003) | - Fir Green (RAL 6009) | - Window Grey (RAL 7040) | - Jet Black (RAL 9005) |
| - Steel Blue (RAL 5011) | - Anthracite Grey (RAL 7016) | - Ochre Brown (RAL 8001) | - White Aluminium (RAL 9006) |
| - Pigeon Blue (RAL 5014) | - Stone Grey (RAL 7030) | - Clay Brown (RAL 8003) | - Grey Aluminium (RAL 9007) |

Special RAL colours are:

- | | | | |
|-------------------------|--------------------------|-----------------------------|----------------------------|
| - Black Red (RAL 3007) | - Black Grey (RAL 7021) | - Signal Black (RAL 9004) | - Traffic Black (RAL 9017) |
| - Black Blue (RAL 5004) | - Black Brown (RAL 8022) | - Graphite Black (RAL 9011) | |

Non standard RAL colours are:

Based on full RAL colour chart excluding Traffic Purple (RAL 4006), Purple Violet (RAL 4007), Sapphire Blue (RAL 5003) and pearlescent or florescent options.

Timber effect foil coated doors are available in the following five finishes:

Golden Oak, Dark Oak, Night Oak, Rosewood and Winchester Oak.

Foil coated finish also available in Titan Metallic (CH703)

Handle

Sectional doors are supplied ex-works for automatic operation, i.e. without handle hole and lock. Factory-fitted handle and lock are available with an increased lead-time. For electrical operation of a garage with no other personal access, an emergency release kit must be fitted.

Packaging

Sectional doors are provided in a palletted format shrink wrapped for easy handling.

Stock availability

Popular sectional doors are generally ex-stock in White (RAL 9016) and Terra Brown (RAL 8028), other sizes and colour options require up to 6 weeks lead-time. Contact sales office for further details.

Gears

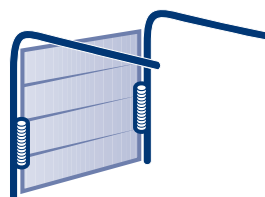

Tension spring

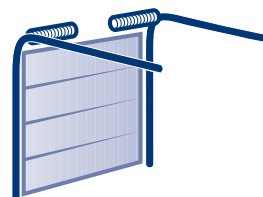

Torsion spring

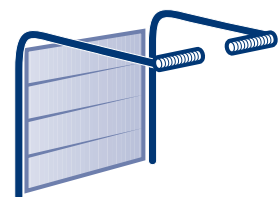

Low headroom
torsion spring fitting

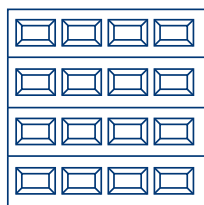

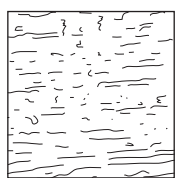

Georgian design

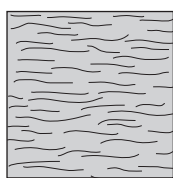

Woodgrain

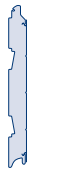

Timber effect

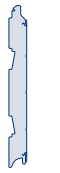
Size Code	Brickwork opening Width x Height (mm x mm)	 			Surcharge for Standard Colours	Surcharge for Non-Std. Colours	Surcharge for Special RAL	
		Premium	Classic					
61062	2080 x 1875	944	716	1234	145	199	398	As standard with tension spring fitting, torsion spring fitting available for Premium doors at £ 48 surcharge.
61066	2080 x 2000	987	-	1258	154	212	424	
610610	2080 x 2080	999	740	-	161	221	441	
7066	2134 x 2000	1022	728	1258	158	218	435	
7070	2134 x 2125	1035	740	1272	168	231	463	
7666	2286 x 2000	1022	728	1258	170	233	466	
7670	2286 x 2125	1035	740	1272	180	248	495	
7674	2286 x 2250	1034	772	1389	191	262	525	
7679	2286 x 2375	1103	889	1420	201	277	554	
7682	2286 x 2500	1100	887	1471	212	291	583	
8066	2438 x 2000	1078	754	1335	181	249	497	
8070	2438 x 2125	1094	767	1353	192	264	528	
8074	2438 x 2250	1090	802	1528	203	280	560	
8079	2438 x 2375	1159	915	1548	215	295	591	
8082	2438 x 2500	1157	914	1577	226	311	622	
8666	2591 x 2000	1078	754	1335	192	264	529	
8670	2591 x 2125	1094	767	1353	204	281	562	
9066	2743 x 2000	1171	874	1464	203	279	559	
9070	2743 x 2125	1189	890	1489	216	297	594	
9666	2895 x 2000	1229	918	1545	215	295	591	
9670	2895 x 2125	1254	933	1572	228	314	628	
1066	3048 x 2000	1181	918	1545	226	311	622	
1070	3048 x 2125	1204	933	1572	240	330	661	
1166	3353 x 2000	1407	-	1837	249	342	684	
1170	3353 x 2125	1433	-	1867	264	363	727	
1266	3657 x 2000	1659	-	2077	271	373	746	
1270	3657 x 2125	1687	-	2111	288	396	793	
1366	3962 x 2000	1725	-	2144	294	404	808	
1370	3962 x 2125	1749	-	2175	312	429	859	
1466	4267 x 2000	1793	-	2210	316	435	870	
1470	4267 x 2125	1822	-	2245	336	462	925	
14666	4420 x 2000	1859	-	2269	328	451	902	
14670	4420 x 2125	1889	-	2306	348	479	958	
1566	4572 x 2000	1892	-	2297	339	466	933	
1570	4572 x 2125	1924	-	2330	360	495	991	
15666	4725 x 2000	1985	-	2340	350	482	964	
15670	4725 x 2125	2016	-	2376	372	512	1024	
1666	4877 x 2000	1985	-	2385	361	497	995	
1670	4877 x 2125	2016	-	2422	384	529	1057	

Purpose-made sizes available upon request. Non standard colours also available upon request. Doors supplied without locking as standard (see options on page 60 for handles). For window options please see page 59.

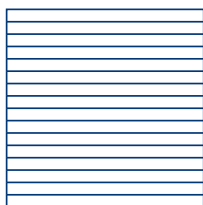

Linear small design

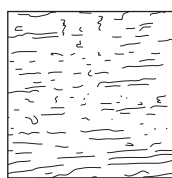

Woodgrain

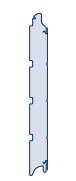

Premium

Classic¹

Size Code	Brickwork opening Width x Height (mm x mm)	Premium	Classic ¹	Surcharge for Standard Colours	Surcharge for Non-Std. Colours	Surcharge for Special RAL
61062	2080 x 1875	752	638	145	199	398
61066	2080 x 2000	784	-	154	212	424
610610	2080 x 2080	814	667	161	221	441
7066	2134 x 2000	811	650	158	218	435
7070	2134 x 2125	840	667	168	231	463
7666	2286 x 2000	811	650	170	233	466
7670	2286 x 2125	840	667	180	248	495
7674	2286 x 2250	852	704	191	262	525
7679	2286 x 2375	917	812	201	277	554
7682	2286 x 2500	915	811	212	291	583
8066	2438 x 2000	853	676	181	249	497
8070	2438 x 2125	885	701	192	264	528
8074	2438 x 2250	892	737	203	280	560
8079	2438 x 2375	960	845	215	295	591
8082	2438 x 2500	957	844	226	311	622
8666	2591 x 2000	853	676	192	264	529
8670	2591 x 2125	885	701	204	281	562
9066	2743 x 2000	923	762	203	279	559
9070	2743 x 2125	954	785	216	297	594
9666	2895 x 2000	965	787	215	295	591
9670	2895 x 2125	1001	817	228	314	628
1066	3048 x 2000	931	787	226	311	622
1070	3048 x 2125	964	817	240	330	661
1166	3353 x 2000	1097	1099	249	342	684
1170	3353 x 2125	1140	1139	264	363	727
1266	3657 x 2000	1287	1215	271	373	746
1270	3657 x 2125	1335	1266	288	396	793
1366	3962 x 2000	1334	1242	294	404	808
1370	3962 x 2125	1384	1291	312	429	859
1466	4267 x 2000	1383	1346	316	435	870
1470	4267 x 2125	1437	1417	336	462	925
14666	4420 x 2000	1428	1376	328	451	902
14670	4420 x 2125	1486	1449	348	479	958
1566	4572 x 2000	1454	1383	339	466	933
1570	4572 x 2125	1511	1455	360	495	991
15666	4725 x 2000	1518	1425	350	482	964
15670	4725 x 2125	1576	1497	372	512	1024
1666	4877 x 2000	1518	1423	361	497	995
1670	4877 x 2125	1576	1497	384	529	1057

As standard with tension spring fitting, torsion spring fitting available for Premium doors at £ 48 surcharge.

As standard with torsion spring fitting.

¹ Only Linear Standard XS windows available.

Purpose-made sizes available upon request. Non standard colours also available upon request. Doors supplied without locking as standard (see options on page 60 for handles). For window options please see page 59.

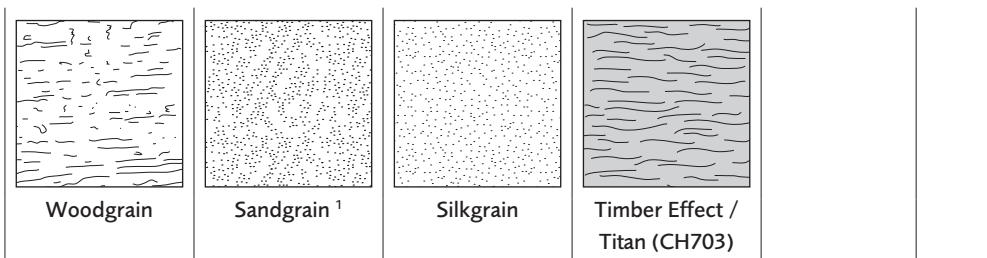

Linear medium design

Size Code Brickwork opening Width x Height (mm x mm)

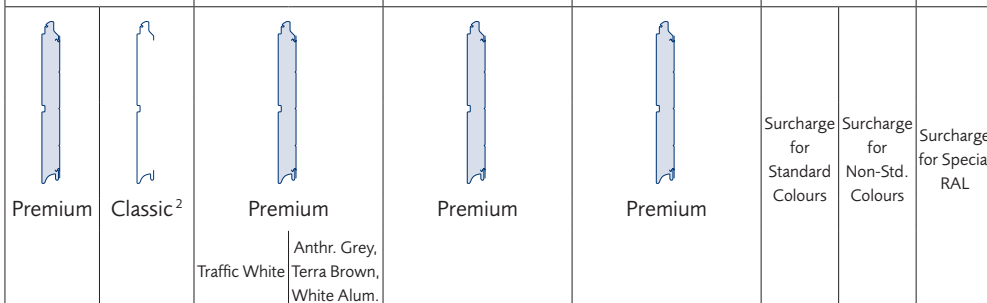

Size Code	Brickwork opening Width x Height (mm x mm)	Premium		Premium		Premium	Premium	Surcharge for Standard Colours	Surcharge for Non-Std. Colours	Surcharge for Special RAL
		752	638	820	919					
61062	2080 x 1875	752	638	820	919	919	1009	145	199	398
61066	2080 x 2000	784	-	858	961	961	1055	154	212	424
610610	2080 x 2080	814	667	891	998	997	1096	161	221	441
7066	2134 x 2000	811	650	858	961	961	1055	158	218	435
7070	2134 x 2125	840	667	891	998	997	1096	168	231	463
7666	2286 x 2000	811	650	858	961	961	1055	170	233	466
7670	2286 x 2125	840	667	891	998	997	1096	180	248	495
7674	2286 x 2250	852	704	934	1047	1046	1150	191	262	525
7679	2286 x 2375	917	812	973	1090	1091	1199	201	277	554
7682	2286 x 2500	915	811	1011	1133	1133	1247	212	291	583
8066	2438 x 2000	853	676	905	1014	1016	1119	181	249	497
8070	2438 x 2125	885	701	944	1058	1060	1167	192	264	528
8074	2438 x 2250	892	737	975	1092	1093	1203	203	280	560
8079	2438 x 2375	960	845	1018	1141	1143	1258	215	295	591
8082	2438 x 2500	957	844	1062	1190	1194	1316	226	311	622
8666	2591 x 2000	853	676	905	1014	1016	1119	192	264	529
8670	2591 x 2125	885	701	944	1058	1060	1167	204	281	562
9066	2743 x 2000	923	762	988	1107	1113	1228	203	279	559
9070	2743 x 2125	954	785	1027	1151	1157	1277	216	297	594
9666	2895 x 2000	965	787	1039	1164	1172	1295	215	295	591
9670	2895 x 2125	1001	817	1080	1210	1218	1347	228	314	628
1066	3048 x 2000	931	787	1039	1164	1172	1295	226	311	622
1070	3048 x 2125	964	817	1080	1210	1218	1347	240	330	661
1166	3353 x 2000	1097	-	1233	1381	1398	1552	249	342	684
1170	3353 x 2125	1140	-	1280	1434	1453	1612	264	363	727
1266	3657 x 2000	1287	-	1386	1553	1577	1754	271	373	746
1270	3657 x 2125	1335	-	1440	1613	1639	1823	288	396	793
1366	3962 x 2000	1334	-	1426	1598	1624	1807	294	404	808
1370	3962 x 2125	1384	-	1479	1657	1685	1876	312	429	859
1466	4267 x 2000	1383	-	1467	1644	1672	1862	316	435	870
1470	4267 x 2125	1437	-	1526	1710	1739	1937	336	462	925
14666	4420 x 2000	1428	-	1503	1684	1715	1910	328	451	902
14670	4420 x 2125	1486	-	1565	1753	1785	1988	348	479	958
1566	4572 x 2000	1454	-	1516	1698	1729	1927	339	466	933
1570	4572 x 2125	1511	-	1578	1768	1801	2007	360	495	991
15666	4725 x 2000	1518	-	1542	1728	1761	1963	350	482	964
15670	4725 x 2125	1576	-	1604	1797	1831	2041	372	512	1024
1666	4877 x 2000	1518	-	1570	1759	1792	1998	361	497	995
1670	4877 x 2125	1576	-	1631	1827	1863	2077	384	529	1057

As standard with tension spring fitting, torsion spring fitting available for Premium doors at £ 48 surcharge.

As standard with torsion spring fitting.

¹ Sandgrain surface available in Traffic White (RAL 9016), Terra Brown (RAL 8028), Anthracite Grey (RAL 7016) and White Aluminium (RAL 9006).

² Only Linear Standard XS windows available.

Purpose-made sizes available upon request. Non standard colours also available upon request.
Doors supplied without locking as standard (see options on page 60 for handles).
For window options please see page 59.

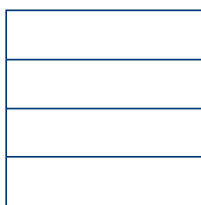

Linear large design

Size Code Brickwork opening Width x Height (mm x mm)

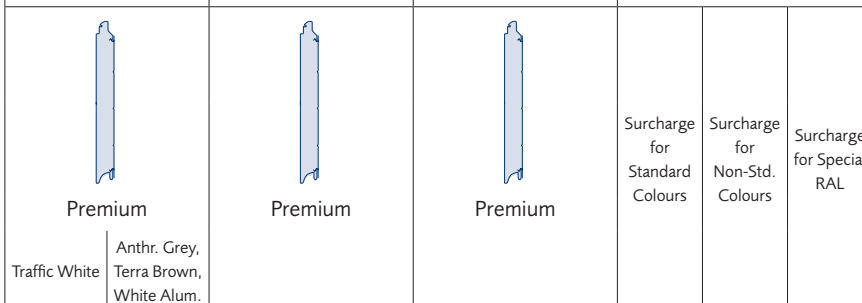
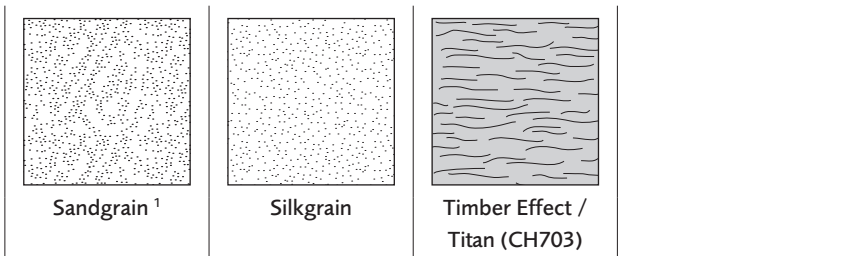

Surcharge for Standard Colours Surcharge for Non-Std. Colours Surcharge for Special RAL









Size Code	Brickwork opening Width x Height (mm x mm)	Premium Traffic White	Premium Anthr. Grey, Terra Brown, White Alum.	Premium	Premium	Surcharge for Standard Colours	Surcharge for Non-Std. Colours	Surcharge for Special RAL
61062	2080 x 1875	973	1090	1049	1151	145	199	398
61066	2080 x 2000	998	1118	1076	1179	154	212	424
610610	2080 x 2080	1010	1132	1089	1193	161	221	441
7066	2134 x 2000	998	1118	1076	1179	158	218	435
7070	2134 x 2125	1010	1132	1089	1193	168	231	463
7666	2286 x 2000	998	1118	1076	1179	170	233	466
7670	2286 x 2125	1010	1132	1089	1193	180	248	495
7674	2286 x 2250	1056	1183	1138	1246	191	262	525
7679	2286 x 2375	1060	1188	1142	1250	201	277	554
7682	2286 x 2500	1088	1219	1171	1282	212	291	583
8066	2438 x 2000	1053	1180	1136	1247	181	249	497
8070	2438 x 2125	1072	1201	1158	1270	192	264	528
8074	2438 x 2250	1127	1263	1216	1335	203	280	560
8079	2438 x 2375	1155	1294	1246	1367	215	295	591
8082	2438 x 2500	1188	1331	1281	1406	226	311	622
8666	2591 x 2000	1053	1180	1136	1247	192	264	529
8670	2591 x 2125	1072	1201	1158	1270	204	281	562
9066	2743 x 2000	1156	1295	1249	1374	203	279	559
9070	2743 x 2125	1171	1312	1265	1391	216	297	594
9666	2895 x 2000	1216	1362	1316	1450	215	295	591
9670	2895 x 2125	1235	1384	1336	1471	228	314	628
1066	3048 x 2000	1216	1362	1316	1450	226	311	622
1070	3048 x 2125	1235	1384	1336	1471	240	330	661
1166	3353 x 2000	1441	1614	1564	1729	249	342	684
1170	3353 x 2125	1463	1639	1588	1754	264	363	727
1266	3657 x 2000	1624	1819	1766	1956	271	373	746
1270	3657 x 2125	1653	1852	1798	1991	288	396	793
1366	3962 x 2000	1675	1876	1823	2020	294	404	808
1370	3962 x 2125	1699	1903	1848	2047	312	429	859
1466	4267 x 2000	1725	1932	1878	2081	316	435	870
1470	4267 x 2125	1753	1964	1908	2115	336	462	925
14666	4420 x 2000	1773	1986	1930	2140	328	451	902
14670	4420 x 2125	1800	2016	1960	2173	348	479	958
1566	4572 x 2000	1791	2006	1951	2163	339	466	933
1570	4572 x 2125	1819	2038	1982	2198	360	495	991
15666	4725 x 2000	1824	2043	1987	2204	350	482	964
15670	4725 x 2125	1855	2078	2020	2241	372	512	1024
1666	4877 x 2000	1855	2078	2022	2243	361	497	995
1670	4877 x 2125	1888	2115	2058	2283	384	529	1057

As standard with tension spring fitting, torsion spring fitting available for Premium doors at £48 surcharge.

As standard with torsion spring fitting.

¹ Sandgrain surface available in Traffic White (RAL 9016), Terra Brown (RAL 8028), Anthracite Grey (RAL 7016) and White Aluminium (RAL 9006).

Purpose-made sizes available upon request.
 Doors supplied without locking as standard (see options on page 60 for handles).
 For window options please see page 59.

Window options									Standard colour - Add £	Non standard colour - Add £	Special RAL colour - Add £
Prices £ stated per window	Georgian Standard	Georgian Cross	Georgian Diamond	Georgian Sunrise	Linear Standard XS	Linear Standard X ¹	Linear Cross X	Linear Standard ² XL			
Woodgrain Georgian											
Premium	87	101	92	101	-	-	-	-	24	42	84
Classic	75	84	84	84	-	-	-	-	24	42	84
Woodgrain, Sandgrain and Silkgrain Linear											
Premium	-	-	-	-	101	87	101	101	22	40	80
Classic	-	-	-	-	80	75	84	84	22	40	80
Timber effect³											
Premium	108	122	122	122	123	108	122	122	-	-	-

¹ Linear Standard X and Cross X windows only available on Linear Medium and Linear Large Designs.

² Linear Standard XL windows only available on Linear Large Designs

³ Window frames are painted in a colour to best match the colour of the foil coat.

Georgian windows

Doors up to 2070 mm wide have 3 windows, 2075 mm to 2740 mm wide have 4 windows, 2895 mm to 3353 mm wide have 5 windows, 3657 mm to 3962 mm wide have 6 windows, 4267 mm to 4725 mm have 7 windows and doors over 4877 mm wide have 8 windows (except Classic panels of 2080 mm wide which have 4 and then 2743 mm wide which have 5).

Linear Standard XS

Doors up to 2438 mm wide have 2 windows, 2591 mm to 3353 mm wide have 3 windows, 3657 mm to 4420 mm wide have 4 windows and doors over 4572 mm wide have 5 windows.

Linear Standard X & Cross X

Doors up to 2080 mm wide have 3 windows, 2134 mm to 2743 mm wide have 4 windows, 2895 mm to 3353 mm wide have 5 windows, 3657 mm to 3962 mm wide have 6 windows, 4267 mm to 4725 mm wide have 7 windows and doors of 4877 mm wide have 8 windows.

Linear Standard XL

Doors up to 2134 mm wide have 2 windows, 2286 mm to 2895 mm wide have 3 windows, 3048 mm to 3962 mm wide have 4 windows, 4267 mm to 4420 mm wide have 5 windows and doors over 4725 mm have 6 windows.

Please state on order if clear or crystal panes.

Options for sectional doors

add

Special anchor set (required if you fix the door between brickwork and fasten the frame on the side).
If using special anchor set 90 mm cover profiles will be required to cover fixing holes.

41

Please note: Frame legs for brown and any coloured doors come in white as standard, matching cover profiles are available. Silkgrain, Foil Coated Timber Effect and Titan Metallic (CH703) are available ex-stock. Please however note Colours and RAL to choose must be ordered with the door and cannot be ordered as a spare part at a later time.

Cover Profiles

Door height	White				Colour				RAL to choose				Foil Coated Timber Effect / Titan (CH703)	
	Woodgrain		Sandgrain/Silkgrain		Woodgrain		Sandgrain/Silkgrain		Woodgrain		Silkgrain		55	90
1875 - 2000	44	59	48	65	57	84	61	88	78	119	84	128	69	96
2001 - 2125	47	62	51	69	60	89	65	93	82	127	89	135	73	102
2126 - 2250	50	66	54	73	64	94	68	99	87	134	94	143	78	108
2251 - 2375	52	69	57	77	67	99	72	104	92	141	99	151	82	114
2376 - 2500	55	73	60	81	70	104	76	109	96	148	104	158	86	119

ThermoFrame set

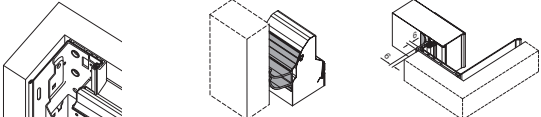
ThermoFrame set 1	Door height	up to 3000 mm	(length 3210 mm)	per set	200
	Door width	up to 3250 mm	(length 3250 mm)		
ThermoFrame set 2	Door height	up to 3000 mm	(length 3210 mm)	per set	238
	Door width	from 3250 mm up to 6000 mm	(length 6000 mm)		
ThermoFrame set 3	For doors with track application H		(length 6000 mm)	per set	238
			(length 5500 mm)		
			Set consists of <ul style="list-style-type: none"> • Lintel seal (1x) with 2 lip seals • Plastic angle profiles (2x) black, 84 x 22.5 mm with lip seal (frame covering may be required to match the colours) 		

Purpose-made width cut-down service (check for size limitations).
Cut-down service not available on Classic Doors.

98

Classic black handle set and lock for on-site installation

48

White finish cast aluminium handle set and lock for on-site installation

120

Silver finish cast aluminium handle set and lock for on-site installation

120

Chrome effect stainless steel handle set and lock for on-site installation

140

Brushed chrome effect stainless steel handle set and lock for on site installation

162

Factory-fitted handle and lock available with a 2 week increase in lead-time
(complete with classic black handle as standard)

73

Standard headroom torsion spring for sectional door less than 3050 mm wide

50

Low headroom tracks arrangement for torsion spring door over 3050 mm wide (when purchased with door)

98

Sectional doors up to 3050 mm wide and/or 2625 mm high:

These doors come with tension spring fitting. With doors from the Premium range the tension springs can be replaced by torsion springs as an option. Tension springs are suitable for low headroom installations. For a low headroom installation with torsion springs please order low headroom track set separately (changing to a low headroom option is not available as a retrofit).

 **Sectional garage door with tension spring fitting**

Minimum garage dimensions for manually operated doors

Headroom:	100 mm
Sideroom:	90 mm (each side)
Depth into garage:	garage door height + 510 mm
Clear passage height for manually operated doors:	garage door height – 80 mm

Minimum garage dimensions for doors with GaraMatic operator

Headroom	115 mm
Sideroom:	90 mm (each side)
Depth into garage:	for doors up to 2125 mm high: 3200 mm for doors up to 2500 mm high: 3450 mm for doors up to 3000 mm high: 4125 mm
Clear passage height for doors with GaraMatic operator:	garage door height – 30 mm

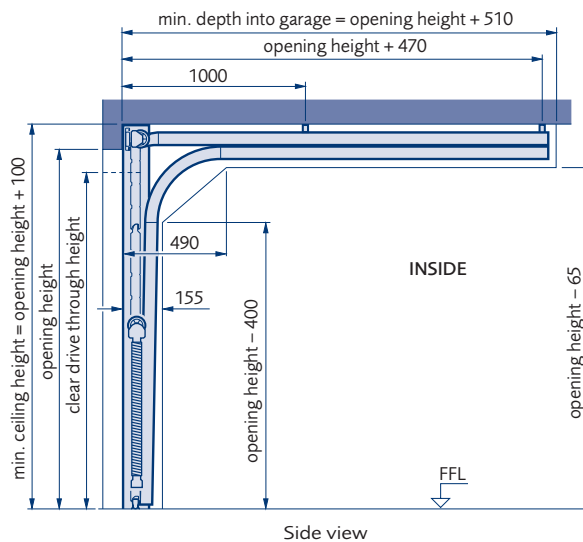

Side view

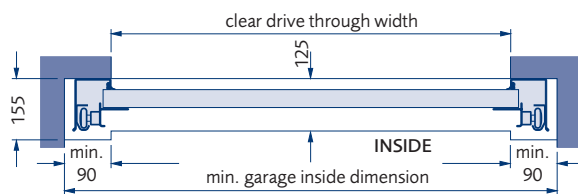

Plan view

Sectional doors wider than 3050 mm wide and/or 2625 mm high:

These doors come with torsion springs as standard. For a low headroom installation with torsion springs please order low headroom track pack (changing to a low headroom option is not available as a retrofit).



Sectional garage door with torsion spring fitting

Minimum garage dimensions for manually operated doors

Headroom:	210 mm
Sideroom:	90 mm (each side)
Depth into garage:	garage door height + 510 mm
Clear passage height for manually operated doors:	garage door height – 50 mm

Minimum garage dimensions for doors with GaraMatic operator

Headroom:	210 mm
Sideroom:	90 mm (each side)
Depth into garage:	for doors up to 2125 mm high: 3200 mm for doors up to 2500 mm high: 3450 mm for doors up to 3000 mm high: 4125 mm
Clear passage height for doors with GaraMatic operator:	full garage door height

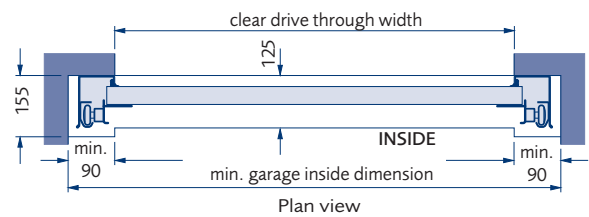
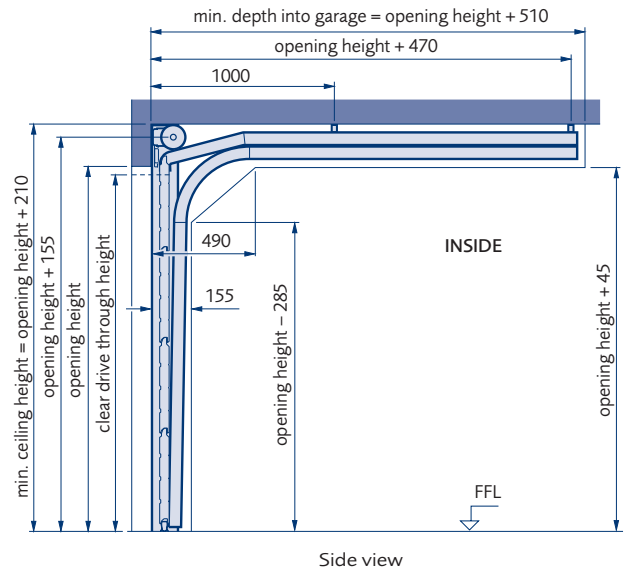

Sectional doors wider than 3050 mm wide and/or 2625 mm high:

These doors come with torsion springs as standard. For a low headroom installation with torsion springs please order low headroom track pack (changing to a low headroom option is not available as a retrofit).

 **Sectional garage door with low headroom torsion spring fitting**

Minimum garage dimensions for manually operated doors

Headroom:	100 mm
Sideroom:	90 mm (each side)
Depth into garage:	garage door height + 510 mm
Clear passage height for manually operated doors:	garage door height – 100 mm

Minimum garage dimensions for doors with GaraMatic operator

Headroom:	115 mm
Sideroom:	90 mm (each side)
Depth into garage:	for doors up to 2125 mm high: 3200 mm for doors up to 3000 mm high: 4125 mm
Clear passage height for doors with GaraMatic operator:	for doors up to 3000 mm wide: garage door height – 30 mm for doors wider than 3000 mm: garage door height – 80 mm

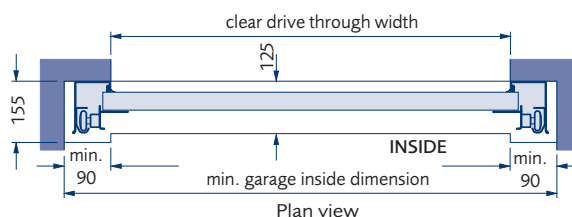
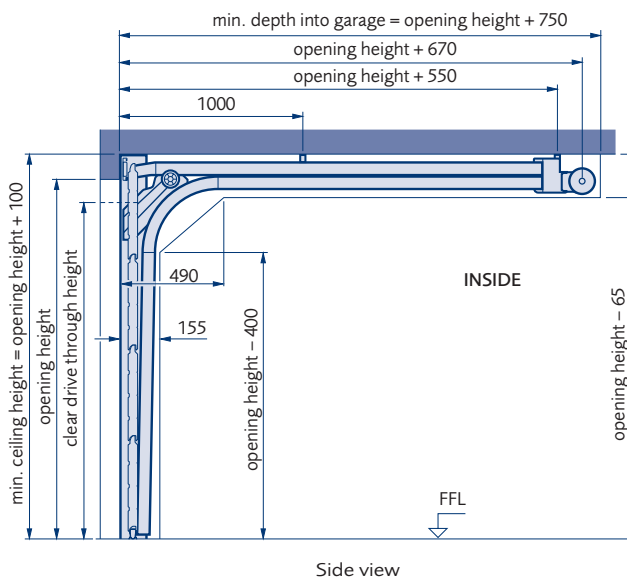

Automation and Accessories

Operators

GaraMatic operators are an ideal match for all current Garador up & over and sectional doors.

As a tried and tested unit hardware on both the door and the operator are perfectly matched and prepared for easy installation.

Safety – in compliance with the latest European standards



Security – integral anti-burglar device

Convenience – super-smooth and maintenance-free

All operators come as a complete set as standard, including operator head, operator rail and two hand transmitters (one 4-channel hand transmitter and one 2-channel micro hand transmitter). All operators perfectly match all current Garador up-and-over and sectional garage doors.

BS 13241 Compliant

The combination of Garador garage doors with GaraMatic operators complies with the latest European safety standards.

Operators	GaraMatic 9	GaraMatic 10	GaraMatic 20
			
	<p>Peak forces 750 N</p> <ul style="list-style-type: none"> • Simple to operate • Soft start and soft stop • Automatic safety reversal • Integral light • Streamlined plastic cover • Partial open function 	<p>Peak forces 800 N</p> <ul style="list-style-type: none"> • 50% faster than other operators • Half-open function for ventilation • Adjustable soft start and soft stop • Automatic safety reversal • Adjustable integral halogen light • Self-closing timer option (light beam device required) 	<p>Peak forces 1000 N</p> <ul style="list-style-type: none"> • 50% faster than other operators • Half-open function for ventilation • Adjustable soft start and soft stop • Automatic safety reversal • Adjustable integral halogen light • Self-closing timer option (light beam device required) • Complete with Light Beam Device as standard
Canopy Doors ¹	471	546	617
Standard short boom ² Retractable and Sectional Doors up to 2125 mm high	374	449	520
Medium boom ²	391	467	537
Long boom ²	481	556	627

¹ Canopy door price includes bow arm system. GaraMatic 9 supplied with two 2-channel hand transmitters.





² For exact boom requirements see grid on page 69.

Supplied with two hand transmitters as standard.

Accessories

				
Article	Hand transmitter 5-channel (Bi-directional) in matt black	Hand transmitter 2-channel (Bi-directional) in matt black	Hand transmitter 5-channel (Bi-directional) in white	Hand transmitter 2-channel (Bi-directional) in white
Reference No.	7471	7470	6713	6711
Price £	68	54	74	59





Accessories





				
Article	Hand transmitter 1-channel (Bi-directional) in black	Hand transmitter 4-channel (Bi-directional) in black	Hand transmitter station in black	Hand transmitter station in white
Reference No.	6710	6779	6719	6720
Price £	54	56	11	11

Accessories



				
Article	Hand transmitter sun visor/ wall holder	1-channel (Bi-directional) transmitter for car cigarette lighter	2-channel (Bi-directional) transmitter for car cigarette lighter	4-channel (Bi-directional) key ring transmitter
Reference No.	6784	6782	6783	6795
Price £	9	51	51	62

Accessories			
Article	Hand transmitter 2-channel (Bi-directional) Burl wood	Hand transmitter 2-channel (Bi-directional) Aluminium	Hand transmitter 2-channel (Bi-directional) Carbon
Reference No.	6968	6967	6966
Price £	73	73	73

Accessories				
Article	Hand transmitter 2-channel (Bi-directional) Green	Hand transmitter 2-channel (Bi-directional) Red	Aluminium designer 2-channel transmitter 868 mHz	Chrome designer 2-channel transmitter 868 mHz
Reference No.	6965	6964	4879	4880
Price £	73	73	76	76

Accessories				
Article	IT3B Wired wall console	FIT2 Bi-directional wireless wall console	IT1B Wired illuminated push button	FCT3 Bi-directional wireless code switch
Reference No.	2873	6718	2875	6717
Price £	36	56	26	91

Accessories			
			
Article	FCT10 Bi-directional wireless code switch (slide lid)	FFL12 Bi-directional wireless finger scan (scan lid)	IT1 Wired push button
Reference No.	6716	6796	695
Price £	149	193	16

Accessories			
			
Article	ESA40 Face fixed key switch	ESU40 Recessed key switch	EL101 Internal light beam device
Reference No.	2876	2877	6786
Price £	47	69	62

Accessories	
	
Article	EL301N External light beam device
Reference No.	2884
Price £	107
	HE3 (Bi-directional) External receiver
Reference No.	6785
Price £	101

Additional options

De-latching kit Reference No. 437.195 for up & over doors (required to maintain mechanical locking system retractable doors only)	42
Emergency release Reference No. 437.205 for retractable up & over doors only (required if door is electrically operated and has no other personal access)	34
Emergency release Reference No. 437.190 for sectional door without handle and lock, or canopy up & over doors (required if door is electrically operated and has no other personal access)	42
Emergency release Reference No. 437.183 for sectional door with handle and lock (required if door is electrically operated and has no other personal access)	42
Lintel extension bracket Reference No. 438.613 for canopy doors (required if door is fitted between brickwork under the lintel)	37

Operator Specifications

Boom for canopy door including canopy bow arm

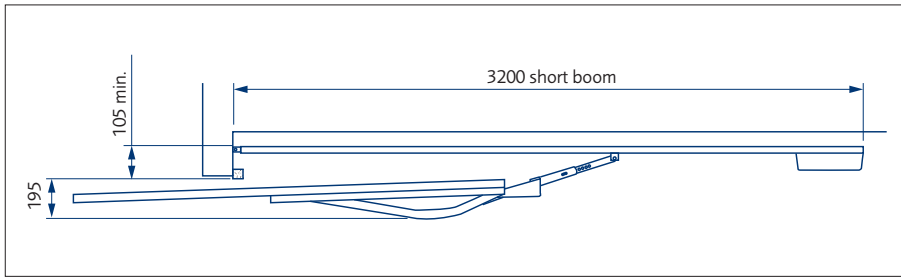

On horizontal doors the bow arm is to be fitted off centre.

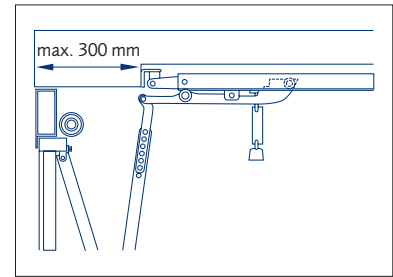

Lintel extension bracket required for canopy doors fitted between the brickwork and under the lintel head.

Boom for retractable door

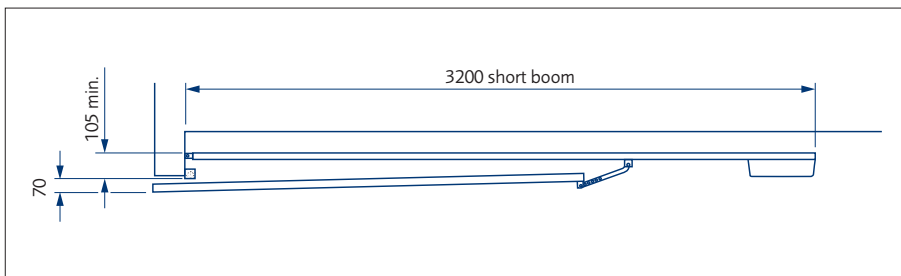

Boom for sectional door

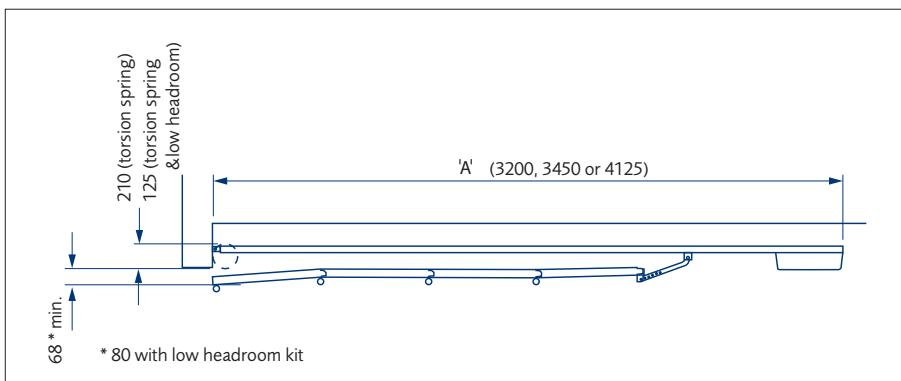

Maximum Door Height to suit Operator Booms

	Torsion Spring	Tension and Low Headroom Spring
Short Boom	2250 mm	2125 mm
Medium Boom	2500 mm	2375 mm
Long Boom	3000 mm	3000 mm

GaraRoll Roller Doors

GaraRoll Insulated Roller Doors

Spring-compensated, automated roller garage door for domestic applications only. All doors are made to suit the opening with the actual door size relating to the structural opening width x height and the guides fitting on the reveals to maintain a full opening size. The GaraRoll is the only roller garage door to include the cover hood, which the curtain rolls into at the head of the garage door opening, as standard.

Door curtain

77mm rolled aluminium profile filled with 100% CFC-free polyurethane rigid foam. Integrated windlocks fitted as standard.

Surface

Colour finish with double layer coil coating quality paint system or foil-coated timber effect finish.

Frame

Aluminium extrusion profile side guides with integrated plastic runners. Lintel and cover box made of steel. Colour of side guides and lintels supplied to match the door as standard. On timber effect doors inside is dark brown. Cover box coated Grey White (RAL 9002).

Counterbalance

Tension spring technology with lateral integral double tension springs and double cables encased within a transparent cover.

Colours

Available in Traffic White (RAL 9016), Ruby Red (RAL 3003), Steel Blue (RAL 5011), Moss Green (RAL 6005), Terra Brown (RAL 8028), Jet Black (RAL 9005), Anthracite Grey (RAL 7016), White Aluminium (RAL 9006), Light Ivory (RAL 1015), Cream (RAL 9001), Light Grey (RAL 7035), same colour inside and outside. Deco paint doors available in Golden Oak and Rosewood with the same finish inside and out. Foil-coated doors available in Golden Oak and Rosewood, with the inside of the lath in dark brown.

Operator and Control

Garador operator and control included. 24 V DC gear drive, mains voltage 230-240 V AC, 0.5 kW, opening speed approx. 11 cm/s, integrated door security kit, operator always located on left (viewed from inside), plastic housing. Micro-processor control in separate plastic housing, automatic teaching of auto safety cut-out and travel limits, soft start and soft stop, light, impulse control, adjustable automatic timer (hold-open time 30 sec. after activation, additional photocell required). Included: 2 hand transmitters and integral receiver, connecting lead with CEE plug, control buttons in cover of the control unit, integrated 2-minute garage light in control housing, quick release (operated from inside).

Windows

Window size approx. 120 x 40 mm, number of windows per door section depends on door width. Windows made of clear synthetic pane with black window frame on exterior, transparent frame on interior. Maximum of 10 window sections per door. Window arrangement:

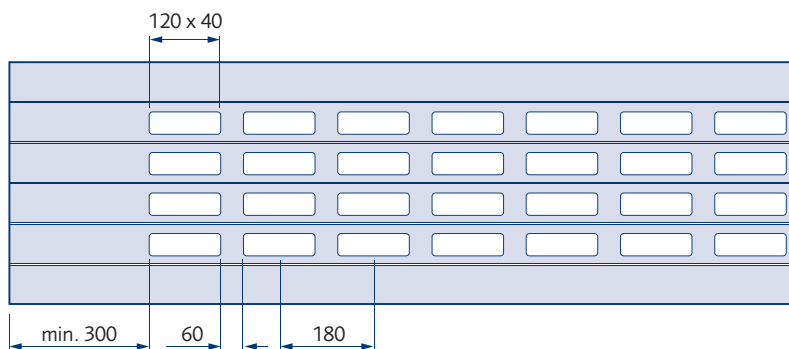

Packaging

GaraRoll doors are supplied in a palletted format shrink wrapped as a complete package.

Stock availability

All GaraRoll doors are made to order with no standard sizes. Lead-time for all doors is 3 to 4 weeks.

Remember the GaraRoll door is measured as opening size and not as overall guide width.

This not only makes it the same as all other Garador doors for sizing but also will probably reduce the price against other doors as most other door manufacturers calculate the price as over guide width thus making the actual door around 200 mm smaller!

Minimum product dimension is 1000 mm x 1600 mm.

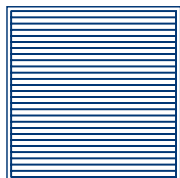

Smooth Paint Finish

Door width

Door height	1000	1250	1500	1750	1900	2000	2250	2500	2750	3000	3250	3500	3750	4000	4250	4500	4750	5000
1600		1290	1290	1315	1315	1328	1402	1451	1501	1523	1601	1653	1863	1910	1997	2044	2093	2143
1875		1290	1290	1315	1315	1328	1402	1451	1501	1523	1601	1653	1863	1910	1997	2044	2093	2143
2000		1290	1290	1315	1315	1377	1466	1491	1533	1576	1660	1717	1944	1964	2086	2134	2184	2233
2125		1290	1290	1315	1315	1402	1512	1549	1583	1642	1747	1934	2011	2031	2146	2194	2244	2292
2250		1290	1290	1315	1315	1402	1512	1549	1583	1642	1747	1934	2011	2031	2146	2194	2244	2292
2375		1379	1379	1430	1430	1450	1537	1589	1649	1697	1807	2009	2049	2131	2221	2271	2320	2367
2500		1379	1379	1430	1430	1499	1584	1635	1698	1763	2002	2089	2165	2240	-	-	-	-
2625		1379	1379	1430	1430	1499	1584	1635	1698	1763	2002	2089	2165	2240	-	-	-	-
2670		-	-	-	-	1499	1584	1635	1698	1763	2002	2089	2165	2240	-	-	-	-
2750		-	-	-	-	1520	1653	1697	1751	1795	2063	2137	2227	2272	-	-	-	-
2875		-	-	-	-	1520	1653	1697	1751	1795	2063	2137	2227	2272	-	-	-	-
3000		-	-	-	-	1520	1653	1697	1751	1795	2063	2137	2227	2272	-	-	-	-
3100		-	-	-	-	1520	1653	1697	1751	1795	2063	2137	2227	2272	-	-	-	-

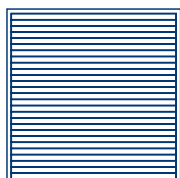

Deco Paint Finish

Door width

Door height	1000	1250	1500	1750	1900	2000	2250	2500	2750	3000	3250	3500	3750	4000	4250	4500	4750	5000
1600		1333	1341	1374	1379	1395	1478	1535	1593	1623	1710	1770	1988	2043	2139	2194	2251	2309
1875		1337	1346	1380	1386	1402	1486	1544	1603	1634	1722	1782	2002	2058	2155	2210	2269	2328
2000		1340	1349	1384	1390	1456	1555	1590	1641	1694	1788	1855	2092	2122	2253	2311	2371	2430
2125		1343	1353	1388	1394	1486	1606	1653	1698	1767	1882	2080	2167	2197	2323	2382	2442	2500
2250		1346	1356	1392	1399	1490	1611	1659	1704	1774	1890	2088	2176	2207	2333	2392	2452	2511
2375		1438	1449	1512	1518	1543	1641	1705	1776	1836	1958	2171	2223	2316	2418	2479	2539	2598
2500		1440	1452	1515	1523	1597	1694	1756	1832	1909	2160	2259	2347	2434	-	-	-	-
2625		1441	1454	1517	1524	1598	1696	1759	1834	1912	2163	2262	2351	2438	-	-	-	-
2670		-	-	-	-	1601	1699	1762	1838	1916	2168	2267	2356	2443	-	-	-	-
2750		-	-	-	-	1627	1773	1830	1897	1955	2236	2323	2427	2485	-	-	-	-
2875		-	-	-	-	1631	1778	1836	1904	1961	2243	2331	2435	2494	-	-	-	-
3000		-	-	-	-	1635	1782	1840	1909	1967	2249	2338	2442	2501	-	-	-	-
3100		-	-	-	-	1635	1782	1840	1909	1967	2249	2338	2442	2501	-	-	-	-

Deco paint only available in Golden Oak or Rosewood finish.

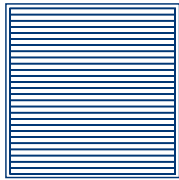

Timber effect Finish

Door height	Door width																		
	1000	1250	1500	1750	1900	2000	2250	2500	2750	3000	3250	3500	3750	4000	4250	4500	4750	5000	
1600																			
1875	1529	1552	1601	1614	1637	1741	1816	1894	1940	2047	2127	2379	2452	2570	2644	2721	2797		
2000	1542	1566	1618	1633	1657	1763	1841	1921	1969	2079	2161	2416	2491	2612	2688	2766	2845		
2125	1550	1576	1629	1644	1723	1847	1901	1972	2046	2164	2252	2528	2576	2736	2816	2896	2976		
2250	1557	1585	1640	1656	1763	1911	1980	2044	2137	2279	2512	2625	2674	2828	2908	2990	3071		
2375	1565	1594	1650	1668	1775	1925	1995	2061	2155	2300	2534	2648	2699	2854	2936	3020	3102		
2500	1671	1701	1788	1806	1840	1966	2053	2150	2234	2385	2638	2713	2832	2962	3048	3132	3214		
2625	1678	1710	1798	1817	1906	2031	2120	2221	2324	2619	2748	2863	2978	-	-	-	-		
2670	1682	1714	1802	1822	1912	2037	2126	2228	2331	2627	2756	2872	2987	-	-	-	-		
2750	-	-	-	-	1918	2045	2135	2238	2343	2639	2768	2885	3000	-	-	-	-		
2875	-	-	-	-	1954	2135	2219	2312	2396	2725	2841	2976	3061	-	-	-	-		
3000	-	-	-	-	1965	2149	2234	2329	2414	2746	2864	2999	3086	-	-	-	-		
3100	-	-	-	-	1975	2160	2246	2343	2429	2761	2880	3018	3105	-	-	-	-		

Timber Effect Foil Coat only available in Golden Oak and Rosewood finish.

Options for all GaraRoll doors

add

Manually operated version	Price reduction	154
Removal of barrel casing (optional only on door height 2500 mm and over)	Price reduction per m	13
External fit (reverse rolled)		58
Chamfered bottom profile available only in White or Colour. Not available in timber effect finish	per m	176
Ventilation grilles or Glazing element with clear synthetic pane, window section 120 x 40 mm, black glazing frame on exterior, transparent on interior (maximum of 10 sections per door, number of glazing elements dependent on the door width)	per m	19

Accessories for RollMatic operator

add

Bi-directional hand transmitter, 4-channel in black		56
Bi-directional hand transmitter mini, 2-channel in black		54
Motor connection line, 10 m - Reference No. 436.523		29
Acoustic door security kit - Reference No. 436.524		49
Emergency battery HNA 18 - Reference No. 437.726		126
Exterior emergency release - Reference No. 436.526		78
Additional fascia panel required when fitting a door within the opening, ordering size will need to be door size plus guide width (price per metre) supplied in colour to match the door / guides		43

All other operator accessories can be combined with GaraRoll roller doors. Please see page 65 to page 68.

Roller door fitting dimensions

Fitting behind the opening

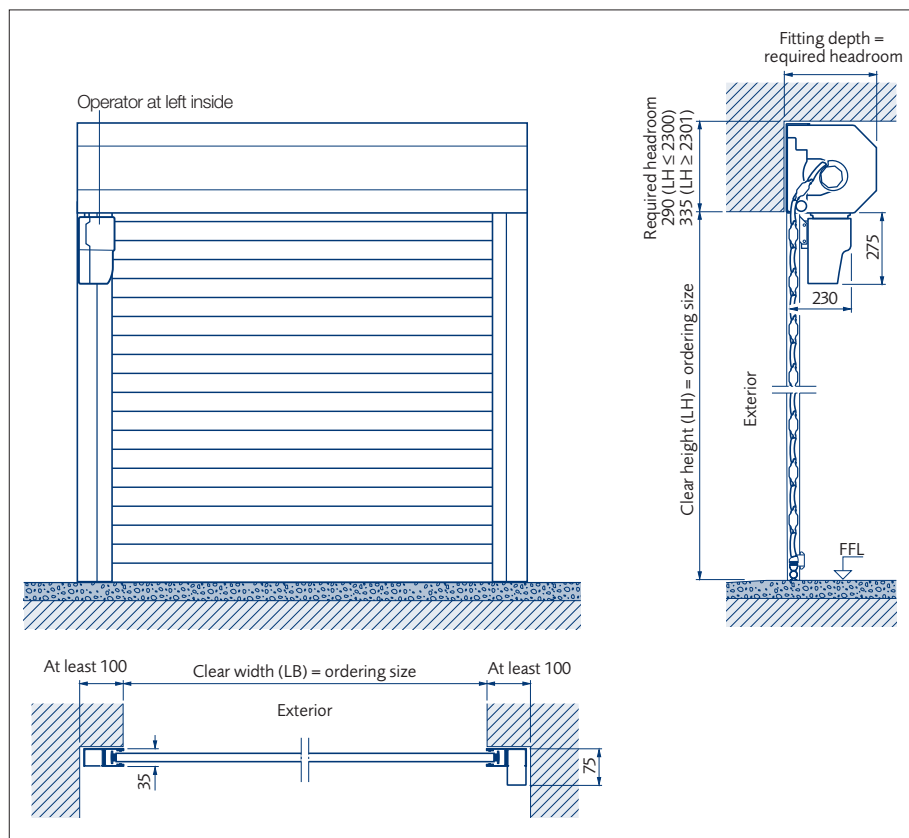

Clear passage height =
clear height (ordering size)
– 60 mm for automated version,
– 140 mm for manually operated version

Clear passage width =
clear width (ordering size)

Fitting in the opening

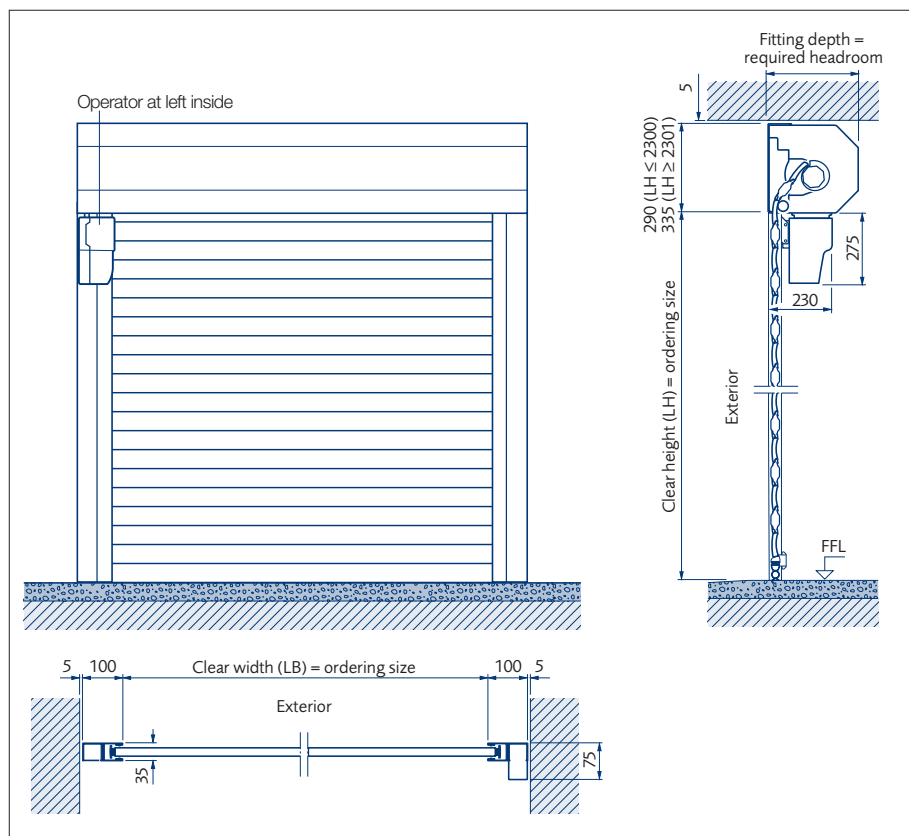

Clear passage height =
clear height (ordering size)
– 60 mm for automated version,
– 140 mm for manually operated version

Clear passage width =
clear width (ordering size)

FrontGuard Entrance Doors

FrontGuard Steel Door FGS

Steel door leaf with foam filled core and thermal break, exterior and interior overlapping the leaf, 46 mm thick, in classic, contemporary and modern designs. Standard polyester primer coating White (RAL 9016) in a smooth finish (inside and out).

Surface

Flush fitting door leaf on the interior and exterior of the door, with a leaf frame on the inside and a thick rebate. The flush fit on the interior gives the impression of a residential internal door can be optimally integrated into your house's interior.

Colours

White (RAL 9016) as standard.

Optional colours available for all doors:

White Aluminium (RAL 9006), Terra Brown (RAL 8028), Clay Brown (RAL 8003), Ochre Brown (RAL 8001), Window Grey (RAL 7040), Light Grey (RAL 7035), Anthracite Grey (RAL 7016), Moss Green (RAL 6005), Ruby Red (RAL 3003), Light Ivory (RAL 1015) and Pigeon Blue (RAL 5014).

Timber Effect

Optional surface finishes available for FGS 010, FGS 015, FGS 700 and FGS 900:

Foil-coated timber effect in Golden Oak, Dark Oak, Night Oak, Winchester Oak and foil coated Titan Metallic finish.

Seals

4-sided double, black EPDM seals. Brush seal at the bottom, 20 mm high plastic threshold with thermal break.

Locks & bolts

11-point security: 2 conical swing bolts engage with 2 additional security bolts and 1 deadbolt in the frame's lock plates. 3 further security bolts on the hinge side and three barrel hinges.

Drip angle

Optional, Traffic white (RAL 9016). Invisible fastening and plastic cover cap at each end.

Hinges

Three 2-piece 3-way adjustable hinges with hinge caps in aluminium look.

Handles / Letter plates

Lever/lever handle set and letter plate in gold or silver to choose as standard on classic designs.

'Secured by Design' handle sets and lever/knob handle sets also available as an option.

Contemporary and modern designs all have fixed bar handles on the outside and therefore a key is required to open these doors from the outside at all times.

Profile cylinder and keys

Cylinder length with fixed bar handles: 27.5 x 35.5 mm.

Cylinder length with standard lever/lever or lever/knob handle set: 31.5 x 40.5 mm.

Cylinder length with Secured by Design lever/lever or lever/knob handle set: 35.5 x 40.5 mm.

5 keys supplied as standard, 8 or 10 keys available as an option.

Windows

- FGS 200, FGS 400: 24 mm double pane insulated safety glass.
Hammered glass design on the inside, clear on the outside.
Composite glazing frame, surface-mounted composite rails.
- FGS 020, FGS 025, FGS 030: 24 mm double pane insulated safety glass.
Mastercarré glass design in matt finish on the inside, clear on the outside.
Roundstyle composite frame, bonded.
- FGS 040: 24 mm double pane insulated safety glass.
Ornamental glass design on the inside, clear on the outside.
Roundstyle composite frame, bonded.
- FGS 700, FGS 750, FGS 850,
FGS 900: Triple pane insulated safety glass, 44 mm thick.
Sand-blasted with matt/clear finish stripes inside, clear outside.
Flush-fitting glazing frames in stainless steel, bonded.

Side elements/transom lights

- FGS 100, FGS 200: 46 mm thick side element comes with 3 raised panels.
- FGS 400: 24 mm double pane insulated safety glass
Hammered glass design on the inside, clear on the outside.
Composite glazing frame, surface-mounted composite rails.
- FGS 020, FGS 025, FGS 030: 24 mm double pane insulated safety glass.
Mastercarré glass design in matt finish on the inside, clear on the outside.
Roundstyle composite frame, bonded.
- FGS 040: 24 mm double pane insulated safety glass.
Ornamental glass design on the inside, clear on the outside.
Roundstyle composite frame, bonded.
- FGS 700, FGS 750, FGS 850,
FGS 900: Triple pane insulated safety glass, 44 mm thick.
Sand-blasted with matt/clear finish inside, clear outside.
Flush-fitting glazing frames in stainless steel, bonded.



Secured by Design
Logo indicates availability of SBD security upgrade, see page 80 for details.

Packaging

FrontGuard doors are packed with polystyrene around the door and then shrink wrapped. Side elements are transported with glass already fitted.

Stock availability



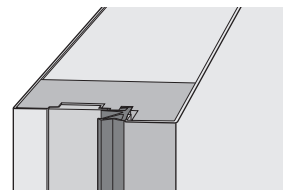

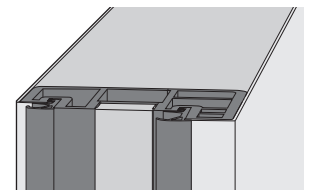

Made to order. Approximately 8 weeks lead time.



FrontGuard

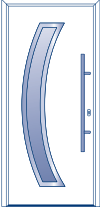



FrontGuard Plus

		Size (W x H)	RAL 9016	Colour	T-Effect	RAL 9016	Colour	T-Effect
Modern								
	FGS 700 ¹	1000 x 2100 1100 x 2100	1563	1741	1776	1900	2078	2113
		from 875 x 1990 up to 1250 x 2250	1848	2026	2061	2185	2363	2398
		U _D -value for size 1230 x 2180 mm: approx. 1.2 W/(m ² ·K)						
	FGS 750 ¹	1000 x 2100 1100 x 2100	1563	1741	1776	1900	2078	2113
		from 875 x 1990 up to 1250 x 2250	1848	2026	2061	2185	2363	2398
		U _D -value for size 1230 x 2180 mm: approx. 1.2 W/(m ² ·K)						
	FGS 850 ¹	1000 x 2100 1100 x 2100	-	-	-	2207	2385	2419
		from 875 x 1990 up to 1250 x 2250	-	-	-	2492	2670	2704
		U _D -value for size 1230 x 2180 mm: approx. 1.2 W/(m ² ·K)						
	FGS 900 ¹	1000 x 2100 1100 x 2100	1704	1882	1917	2041	2219	2254
		from 875 x 1990 up to 1250 x 2250	1988	2166	2201	2325	2503	2538
		U _D -value for size 1230 x 2180 mm: approx. 1.2 W/(m ² ·K)						
Contemporary								
	FGS 010 ¹	1000 x 2100 1100 x 2100	874	1052	1086	1211	1389	1423
		from 875 x 1875 up to 1250 x 2250	1158	1336	1370	1495	1673	1707
		U _D -value for size 1230 x 2180 mm: approx. 1.1 W/(m ² ·K)						
	FGS 015	1000 x 2100 1100 x 2100	939	1117	1152	1276	1454	1489
		from 875 x 1990 up to 1250 x 2250	1224	1402	1437	1561	1739	1774
		U _D -value for size 1230 x 2180 mm: approx. 1.4 W/(m ² ·K)						
	FGS 020	1000 x 2100 1100 x 2100	1197	1587	1622	-	-	-
		from 875 x 1990 up to 1250 x 2250	1481	1871	1906	-	-	-
		U _D -value for size 1230 x 2180 mm: approx. 1.4 W/(m ² ·K)						

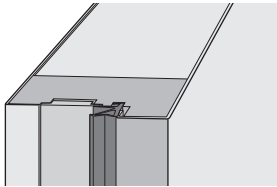
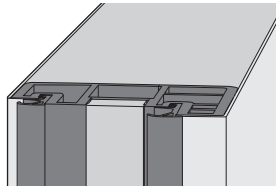

¹ Secured by Design option available on this door. See page 80 for costs.

	 <p>FrontGuard</p>			 <p>FrontGuard Plus</p>		
Size (W x H)	RAL 9016	Colour	T-Effect	RAL 9016	Colour	T-Effect

Contemporary

	FGS 025	1000 x 2100	1261	1651	1686	-	-	-
		1100 x 2100						
		from 875 x 1900 up to 1250 x 2250	1546	1936	1971	-	-	-
U _b -value for size 1230 x 2180 mm: approx. 1.4 W/(m ² ·K)								
	FGS 030 ¹	1000 x 2100	1264	1654	1689	-	-	-
		1100 x 2100						
		from 875 x 1990 up to 1250 x 2250	1549	1939	1974	-	-	-
U _b -value for size 1230 x 2180 mm: approx. 1.2 W/(m ² ·K)								
	FGS 040 ¹	1000 x 2100	1173	1563	1598	-	-	-
		1100 x 2100						
		from 875 x 1875 up to 1250 x 2250	1458	1848	1883	-	-	-
U _b -value for size 1230 x 2180 mm: approx. 1.2 W/(m ² ·K)								

Classic

	FGS 100 ¹	1000 x 2100	898	1076	-	-	-	-
		1100 x 2100						
		from 875 x 1990 up to 1100 x 2186	1183	1361	-	-	-	-
U _b -value for size 1230 x 2180 mm: approx. 1.1 W/(m ² ·K)								
	FGS 200 ¹	1000 x 2100	989	1379	-	-	-	-
		1100 x 2100						
		from 875 x 1990 up to 1100 x 2186	1274	1664	-	-	-	-
U _b -value for size 1230 x 2180 mm: approx. 1.2 W/(m ² ·K)								
	FGS 400	1000 x 2100	1058	1448	-	-	-	-
		1100 x 2100						
		from 875 x 1990 up to 1100 x 2186	1342	1732	-	-	-	-
U _b -value for size 1230 x 2180 mm: approx. 1.4 W/(m ² ·K)								

¹ Secured by Design option available on this door. See page 80 for costs.

Side elements

All FrontGuard doors are available with side elements. Side elements may be on the left and/or right hand side of the door. Side elements come in Traffic White, RAL 9016 as standard.

Side element – standard sizes

Ordering sizes in mm (W x H)	Glass	RAL 9016	Colour	Timber Effect
400 x 2100	Mastercarré	602	699	732
	Clear glass			
	Sandblasted float			
	Ornamental glass 504			
	Cathedral glass			

Decors: Golden Oak, Dark Oak, Night Oak, Winchester Oak, Titan Metallic¹ / Titan Metallic CH 703

¹ The Titan Metallic decor film coating will be replaced by Titan Metallic CH 703 decor, available from Autumn 2014.

Side element – special sizes for modern and contemporary designs

Ordering sizes in mm (W x H)	Glass	RAL 9016	Colour	Timber Effect
From 300 x 1875 to 500 x 2250	Glass in accordance with the overview on page 79	707	811	838
to 1000 x 2250 ²		986	1114	1117

² Only possible without transom light.

Door set with side element does not have a statics function. Statics must be ensured by the building structure.

Decors: Golden Oak, Dark Oak, Night Oak, Winchester Oak, Titan Metallic¹ / Titan Metallic CH 703

¹ The Titan Metallic decor film coating will be replaced by Titan Metallic CH 703 decor, available from Autumn 2014.

Side element – special sizes for classic designs

Ordering sizes in mm (W x H)	Panel / glass	RAL 9016	Colour
From 450 x 1960 to 450 x 2186	Panel <u>without</u> glass in accordance with the overview on page 79	520	617
From 450 x 1960 to 450 x 2186	Panel <u>with</u> glass in accordance with the overview on page 79	575	672

Transom lights

Our FrontGuard doors are available with a transom light. It can be arranged above the door or above door and side element(s). Transom lights come in Traffic White, RAL 9016 as standard.

Transom light

Ordering sizes in mm (W x H)	Glass	RAL 9016	Colour	Timber Effect
From 875 x 300 to 1250 x 500	Glass in accordance with the overview on page 79	566	664	697
to 1750 x 500		711	810	842
to 2250 x 500		852	950	982

Decors: Golden Oak, Dark Oak, Night Oak, Winchester Oak, Titan Metallic¹ / Titan Metallic CH 703



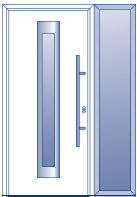
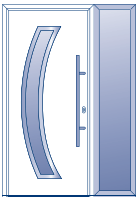
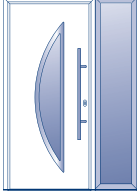

¹ The Titan Metallic decor film coating will be replaced by Titan Metallic CH 703 decor, available from Autumn 2014.

For dimensions please see specifications on page 81

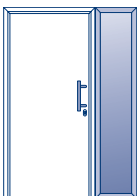
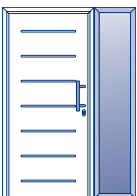

Modern

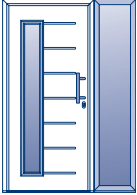
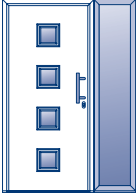

			Glass	Side element	Transom light
 FGS 700	 FGS 750	 FGS 850	<ol style="list-style-type: none"> 1. Clear laminated safety glass / sand-blasted laminated safety glass (without clear stripes) 2. Clear laminated safety glass / clear laminated safety glass 	Width 300 - 1000 mm	Width 875 - 2250 mm
 FGS 900				Height 1990 - 2250 mm	Height 300 - 500 mm

Contemporary



			Glass	Side element	Transom light
 FGS 010	 FGS 015		<ol style="list-style-type: none"> 1. Clear laminated safety glass / Mastercarré single-pane safety glass 2. Clear laminated safety glass / single-pane safety ornamental glass 504 3. Clear laminated safety glass / sand-blasted laminated safety glass (without clear stripes) 4. Clear laminated safety glass / clear laminated safety glass 	Width 300 - 1000 mm	Width 875 - 2250 mm
 FGS 020	 FGS 025	 FGS 030		Height 1875 - 2250 mm	Height 300 - 500 mm
 FGS 040			<ol style="list-style-type: none"> 1. Clear laminated safety glass / Mastercarré single-pane safety glass 2. Clear laminated safety glass / clear laminated safety glass 	Width 300 - 1000 mm	Width 875 - 2250 mm
				Height 1990 - 2250 mm	Height 300 - 500 mm
			<ol style="list-style-type: none"> 1. Clear laminated safety glass / single-pane safety ornamental glass 504 2. Clear laminated safety glass / clear laminated safety glass 	Width 300 - 1000 mm	Width 875 - 2250 mm
				Height 1875 - 2250 mm	Height 300 - 500 mm

Classic

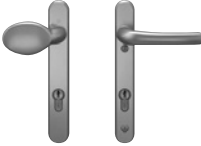
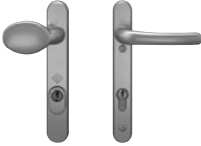



			Glass	Side element	Transom light
 FGS 100	 FGS 200		<ol style="list-style-type: none"> 1. Element with 3 panels 2. Clear laminated safety glass / clear laminated safety glass 3. Clear laminated safety glass / single-pane safety cathedral glass 	Width panel 450 mm, width glass 300 - 1000 mm	Width 875 - 2250 mm
 FGS 400				Height 1990 - 2186 mm	Height 300 - 500 mm
			<ol style="list-style-type: none"> 1. Element with 1 panel and glazing cut-out with clear laminated safety glass / single-pane safety cathedral glass 2. Clear laminated safety glass / clear laminated safety glass 3. Clear laminated safety glass / single-pane safety cathedral glass 	Width panel 450 mm, width glass 300 - 1000 mm	Width 875 - 2250 mm
				Height 1990 - 2186 mm	Height 300 - 500 mm

Optional extras				
Article	Aluminium letter plate in gold or silver ¹	Lever / lever handle set 'Secured by Design' with drill resistant cylinder escutcheon ¹	Outside knob / inside lever in gold or silver ¹	Outside knob / inside lever set 'Secured by Design' with drill resistant cylinder escutcheon ¹
Price £	35	42	40	52

¹ Only available on Classic Range

Optional extras			
Article	Spyhole in brass or chrome (for fitting on site, door leaf supplied undrilled) ²	Profile cylinder complete, supplied with 8 keys	Profile Cylinder Complete, supplied with 10 keys
Price £	17	42	62

² The hole for the spyhole needs to be drilled onsite and the kit needs to be fitted manually.

Optional extras				
Article	Electric strike with day catch (separate)	Large brushed stainless steel handle Surcharge for standard bar handle	Secured by design upgrade ⁴	Stainless steel cleaner and care product (150 ml)
Price £	63	102	90	25

³ Upgrade only available.

⁴ Upgrade available for front door models FGS 100, FGS 200, FGS 010, FGS 015, FGS 030, FGS 040, FGS 700, FGS 900. Upgrade consists of high security cylinder, a safety registration card and three security keys.

FrontGuard Door Specifications

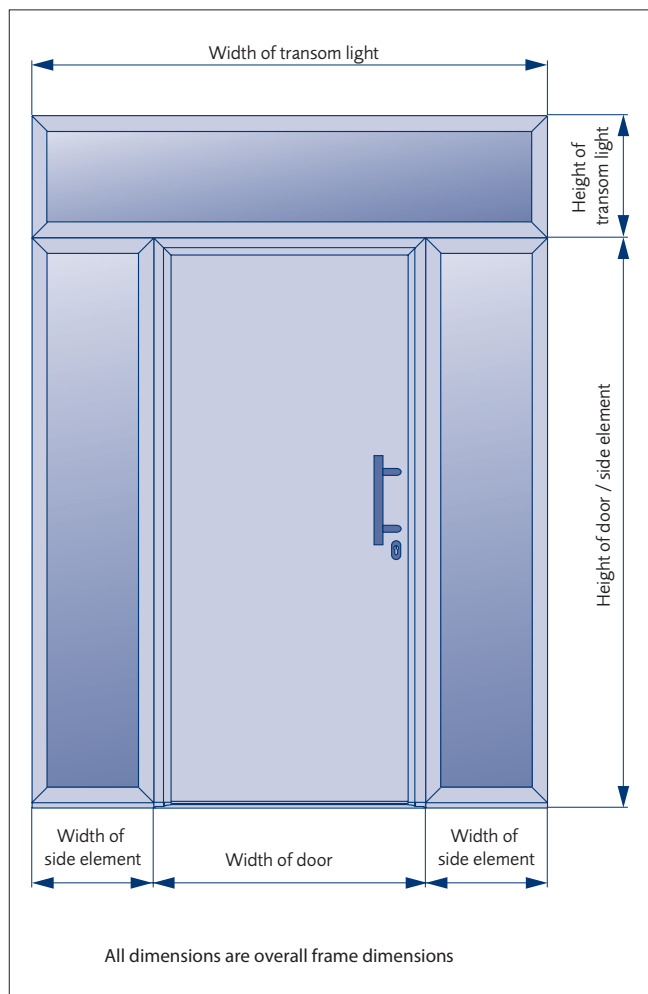

Plan view of door with side element

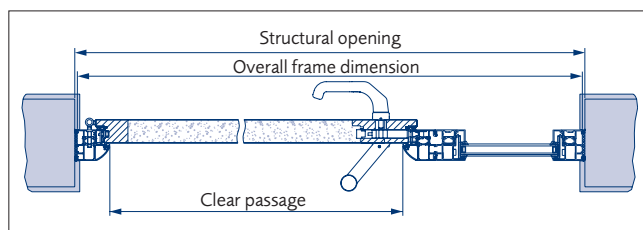

Plan view of door with side element

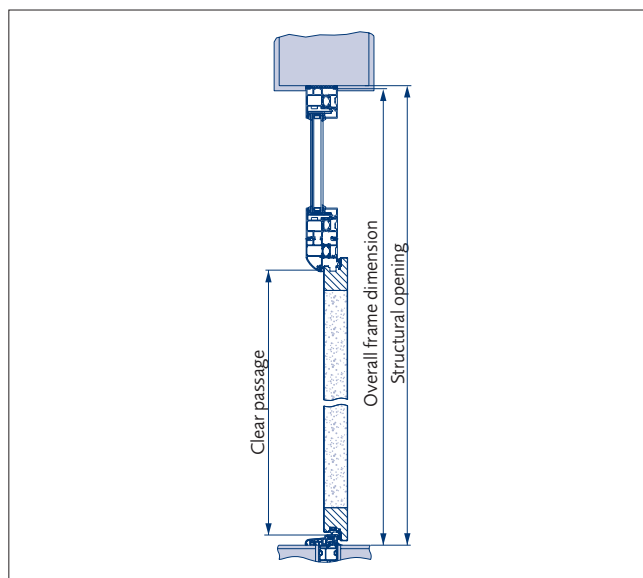

Plan view of door

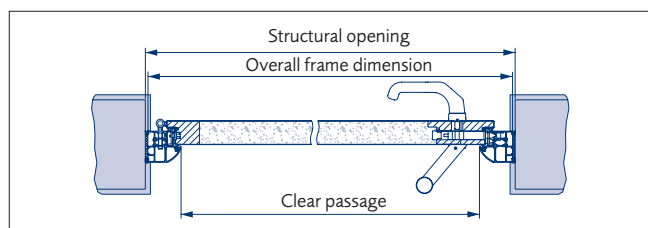

Roundstyle frame

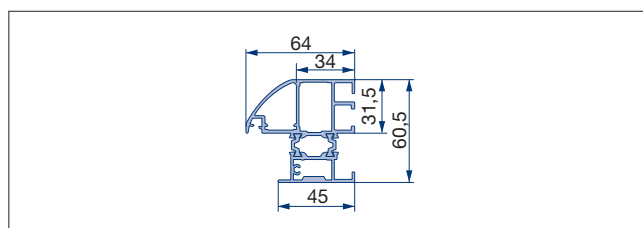

Side view of door

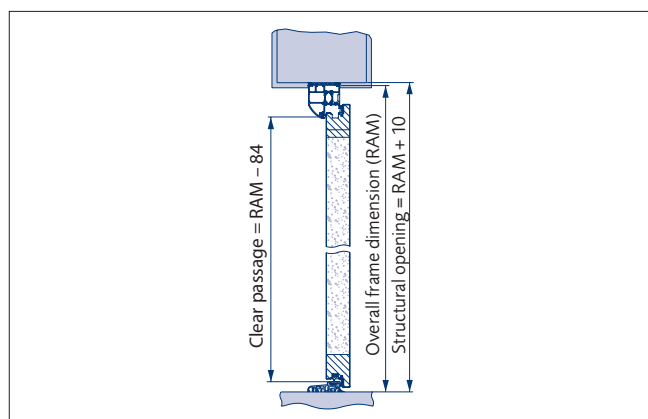

Quadrangular frame

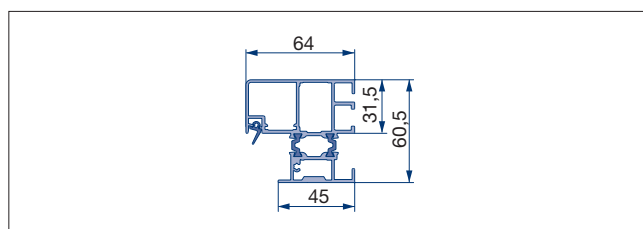

User Information / Care

A Garador garage door needs only a minimum level of preparation and maintenance to give years of trouble-free service. Below is a guide to how to get the best from your garage door.

Operation

- For opening the door in manual operation use only the outside handle or inside handle. Never use the pull rope during the opening cycle of the door.
- For closing the door from the outside – the pull rope fixed to the internal handle is only designed to pull the door towards you whilst standing within the entrance of the garage until the door can be pushed down by hand, then using the external handle for final closing.
- For closing the door from the inside – the pull rope already mentioned is designed to be pulled away from you, when facing the front entrance of the garage, until the internal handle is able to be reached, by hand, and used for final closing. The pull rope is not designed to be used for any other part of the operating cycle, or any other purpose. Failure to comply with the above instructions may result in injury to persons or property.
- When the door is operated from either outside or inside, check the area through which the door will travel is clear from people and objects. Failure to do so may result in injury to persons or property.
- When closing, ensure the latches engage properly.
- If the door is power-operated always try to ensure you match the door with a Garador electric operator.

Power Operated Garage Doors

- It is against the Law to install a power operated garage door in the UK without complying with The Machinery Directive.
- To comply with the Machinery Directive both the door and the operator used in the Installation must have a declaration of Incorporation from the manufacturer.
On completion of the installation the Installer must provide a Declaration of conformity and apply a CE mark giving details of the installation to the door/operator combination, which is now classed as a machine.
- The Installer must issue to the Customer a declaration of conformity on the completion of the installation.
- The Installer must hold copies of both the Declarations of Incorporation and the Declaration of Conformity on a technical file for inspection by the relevant authorities.
- If any of the above requirements are not fulfilled the Installation is illegal.
- Please ensure for your own safety and peace of mind that whoever installs your electric operator is both willing and able to fulfil these requirements; if they are not do not use them !!
- Members of the DHF CAN and WILL install your operator safely and legally.

Cleaning

- The door and frame if applicable, should be washed with a mild soap-based solution on a regular basis to prevent the build up of dirt, salts and other corrosive substances and help maintain the aesthetic appearance of the product.
- If the door is installed in a seafront location, the door panel and frame should be cleaned in this way at least every two months.
- We also suggest that all other components be brushed down on a regular basis to prevent the build up of dirt and dust etc.
- On GaraRoll roller doors regular removal of dirt and debris is required to avoid damage to laths when the curtain rolls.

Locking

- If the key is turned completely, the door is then locked or unlocked; when unlocked it is then possible to open and close the door by turning the handle.
- If the key is turned 1/4 of the way, the door opened and then the key returned to its start position, the door will re-lock when closed.
- By moving the internal locking "snib", it is possible to lock and unlock the door from the inside without using the key.

Maintenance

- If in doubt about any of these maintenance procedures below always consult a Garador specialist. Garador Ltd. has a nationwide network of installers who will be able to offer you a regular maintenance service on your garage door. Please call Garador or refer to the Garador website for further details of your nearest installer.
- Immediately after the door is fitted and after every 5,000 operations of the door, or at least once a year, oil all pivot points, check screws and clamped connections for tightness, keep the running tracks clean (do not grease them), check parts and replace any worn components where necessary.
- The springs should be replaced after approx. 25,000 operations by an experienced door fitter (see fitting and operation instructions).
- Do not oil the lock cylinder; if it is sticking, only lubricate with graphite dust.
- For canopy doors only, check the cable every 6 months with normal usage (8 operations per day). Have the cables replaced by an expert if any wear is found.

Finish – Steel Doors

The coating process applied to the door and chassis is environmentally friendly. Minor scratches or marks are not covered under the conditions of our warranty and should be repaired immediately to prevent corrosion and deterioration of the panel. Corrosive substances such as acids, alkalines, and salts, etc. should be cleaned from the door immediately; failure to do so will result in deterioration of the finish, which will not be covered under our warranty. Should deterioration of the finish start to occur you will need to repaint your door immediately. Prepare the surface lightly with wet and dry. Then treat with solvent based 2 pack epoxy wash primer and a normal commercial paint (cellulose paint must not be used). Garador steel doors are a finished product.

They do not require re-painting on site. They are however not immune to damage, which can occur at any stage of the handling of the product from factory to site.

Finish – Timber Doors

Timber panels are coated with a neutralising base-stain. Doors must be stored upright, under cover, with wrapping intact, until wrapping is removed. As soon as the door is unwrapped, one coat of a good quality basecoat primer must be applied to both sides of the door.

Immediately after installation, your timber doors require a further two coats of a good quality exterior wood finish on both sides.

Initial application and periodic treatment should be carried out strictly in accordance with the woodstain manufacturer's instructions.

Failure to follow these instructions will result in early deterioration of the timber panel.

Finish – GRP Doors

GRP door panels should be periodically washed down using water. This should be done more frequently if fitted near the sea.

Bird droppings will bleach the finish on GRP and should be removed using water as soon as possible.

GRP doors should not be painted over.

Paint Finish – Steel Doors

Minor surface damage can easily be repaired using touch up sprays or sticks without invalidating warranties.

Warranty

Garador products are manufactured to the highest quality standards and leave our factory only after rigorous quality testing. However, if you should have grounds for complaint, this section tells you what our door warranty offers, and how to go about making your claim.

In the unlikely event of a warranty claim becoming necessary, please contact the dealer or distributor who originally supplied your garage door. Your dealer should then supply details of the claim, together with a copy of the warranty card provided with the door and proof of purchase to the Warranty Department at Garador Ltd.

To enable your claim under warranty to be processed as quickly as possible, you should provide the following details:

- 1 Your name, address and telephone number
- 2 Original invoice with date of purchase
- 3 Product description/door type and product number
- 4 Description of defect

An assessment of the claim will then be made. This may require Garador to inspect the product in-situ. In the event that there is no legitimate warranty claim under the terms specified herein, you may be liable for the costs of the inspection visit. We strongly recommend that you take note of the care and usage instructions displayed on the stickers on the back of your garage door and on the page opposite and that you follow these instructions throughout.

Garador installers

Garador Ltd. has a nationwide network of recommended installers who will be able to offer you a regular maintenance service on your garage door. Please call us on 01935 443722 or refer to the Garador website for further details of your nearest installer.

Garador Garage Door Warranty

Warranty Period

The purchaser is granted a warranty covering the safe and reliable function of the Garador garage door for a period of 10 years from the date of purchase. A 5 year warranty applies to springs, wire cables, track rollers, hinges and guide rollers. The warranty period for replacement parts is 6 months or to the end of the current warranty period, whichever is longer.

In the case of foil-coated timber effect and PVC doors, a warranty of 5 years is granted, for timber and GRP doors a warranty of 2 years is granted on the door panels alone under the terms and conditions specified herein. The door mechanism and steel frame (if applicable) is covered by the 10 year warranty period.

Requirements

Warranty claims are only applicable in the country where the garage door was purchased. The product must have been purchased through our authorised distribution channels. The warranty only covers damage to the contract object. The fully completed warranty card together with the receipt of purchase correspondingly dated substantiates your right to claim under the warranty.

Performance

During the warranty period we undertake to rectify any and all defects to the Garador product which can be proved to be attributed to a material or manufacturing fault.

We pledge at our discretion either to exchange the defective merchandise for faultless merchandise, repair it or allow a reduction in price. We do not accept costs for dismantling and installation nor for carriage.

Replaced parts become our property.

The warranty does not cover damage caused through:

- normal wear and tear
- improper installation
- negligent care and maintenance
- improper initial and subsequent operation
- negligent or wanton destruction
- external influences such as fire, water, salts, alkaline solutions, acids, abnormal environmental influences
- mechanical damage through improper transport and fitting
- priming and other surface protection treatments
- incorrect or too late applied surface protection treatments
- repair by non-qualified persons
- using non-Garador parts without the approval of the manufacturer
- Removal of the product number or making it unidentifiable

Electric Operator Warranty

A separate 5 year warranty is granted on our electric operators. This includes operator mechanics, motor and motor control systems. A 2 year warranty is granted on radio equipment, accessories and system controls. There is no warranty on consumables (e. g. fuses, batteries, bulbs etc.). For further details please contact us on 01935 443722, or through our website on www.garador.co.uk

Warranty GaraRoll

Gararoll roller doors are subject to a limited 10 year warranty. The design of these doors represents state of the art technology. Pressure marks and abrasive wear, particularly on the top profiles are a condition of the design and cannot be avoided. They are not considered a reason for complaint. In order to avoid excessive friction, remove any dirt and debris from the door curtain at regular intervals.

Extracts from DHF consumer advice

The following document was designed by the Association of Garage Door Specialists, updated by the DHF and endorsed by all major UK garage door manufacturers, as a guide for purchasers of domestic garage doors.

Visual Appearance of Garage Doors

A new garage door can be a significant investment that will transform the appearance of your home. This information is a guide to the quality you can expect.

The Quality Check

The quality check should be carried out in natural daylight, not direct sunlight. Stand at a distance of 3 metres from the door to view the overall appearance.

The door is acceptable if, taking into account the facts below, none of the following are readily visible on the face of the door:

- Marks or distortion associated with the manufacturing process
- Minor indentations, marks or scuffs on the surface
- Paint or stain blemishes

The Facts

Steel Doors

Panel Distortion

The rolling or pressing of steel panels during manufacture will cause distortion in the steel and while every effort is made to keep this to a minimum, inevitably some visible distortion will remain. The application of high gloss paints will make this slight distortion more apparent, especially under certain lighting conditions, such as car headlamps, or bright sunshine.

Paint Finish

Primed doors – the primer coating is applied as a base coat only and as such requires additional finishing with a good quality exterior paint.

Any marks or scratches on the primer coat should be rubbed down and repainted as part of this finishing process.

Finished doors – the factory application of the paint finish is an automated process and this may result in minor blemishes or slight inconsistencies in the paint, particularly in the area of panel joints.

Timber Doors

Timber

Timber is a natural product and there will be variations in pattern, colour, shading and grains. No two doors will be the same. Wood naturally expands and contracts according to environmental conditions, joints will open and close and some minor curvature may occur.

Finishing

It is vital that timber doors are fully finished as per the manufacturers instructions before exposure to the elements.

GRP and composite

Plastic Doors

Mould Marks

GRP doors are individually handcrafted in a mould and are then hand finished. Some minor marks and blemishes will inevitably remain after this process.

Translucency

When viewed from the inside, it is often possible to see variations in the translucency of the door, particularly around and between areas of relief. Such variations do not detract from the overall strength or build quality of the door.

All Doors

Colour Match

Pairs of doors should be ordered together to obtain the best colour match, bearing in mind the limitations of the materials used in the construction. Timber garage doors cannot be ordered as matching sets.

Size Variations

As the size of a door changes in height and/or width, the panel frequency and profile can change, therefore doors of the same style but of different sizes can be significantly different in appearance.

Clearances

All doors require operating clearances, i.e. the gap between the door panel and the frame opening, these are inbuilt during manufacture and should not be reduced by means of infills, or draughtproofing.

Deflection

When in the open position, all doors will display a level of vertical deflection or 'sag' across the width of the panel. Individual manufacturers' specifications should be consulted for exact tolerances.

GARADOR

The Garage Door People

Bunford Lane, Yeovil, Somerset, BA20 2EJ
Tel: (01935) 443722 Fax: (01935) 443744

www.garador.co.uk



Garador is the UK's leading manufacturer of garage doors and operators, with an ultra-modern production facility located in Somerset. We use German engineering expertise to produce highly sophisticated doors and operators. By purchasing a Garador product you can be assured of the highest level of quality, safety and security. With a nationwide network of stockists, installers and service technicians we are an ideal partner for your project.