



Side Hinged Garage Doors



Traditional



TRADITIONAL - classic design door.
Replace door but not a style!

Double glazed panel with clear, matt, "frosted" or tinted glass.

Any RAL Classic or "Golden Oak" colour.



Flush

Flush design in either woodgrain or stucco finish offers a classic look which suits traditional and modern properties alike. The door can be personalized with attractive window options. You can choose vertical or horizontal panel layout and any colour you like.





Slick

No ribs, no embossing - just a smooth panel. But looks great! Slick design offers exceptional range of colours. In combination with stainless steel windows or appliqués and metallic finish your garage door can look million worth.



Rib

The simplistic Rib design available in both horizontal and vertical versions combined with various woodgrain or stucco colours making it a popular choice.





Midrib

Midrib resembles solid timber planks and is available in various finishes and colours including popular smooth metallic.



Cassette (Georgian)

The popular Georgian design offers curb appeal to all property types. The doors are available in traditional 1/2 : 1/2 split or increasingly popular 2/3 : 1/3 split.





Chevron

The Chevron is uncomplicated traditional design available in various finishes and colours. Normally manufactured with a narrow rib but other designs and options including windows are available.



Stainless steel windows will decorate any door. Play with sizes, shapes, layout.



Stainless steel appliqué can make your door really different and special. Choose from standard appliqué catalogue or create your own personal. Appliqués combined with stainless steel windows can create a stunning effect.



Appliqué catalogue



www.design.ryterna.eu/?language=EN



Think outside the box!
Design, layout, colour – the fantasy is the limit.



The door is rubber sealed all around perimeter and between leaves.

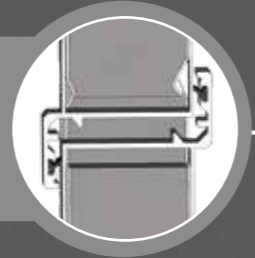

Scratch proof energy efficient double glazing. Acrylic glass.

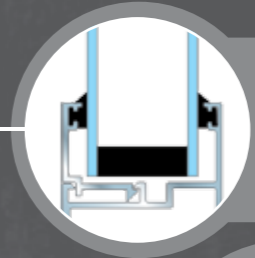

Installation is fast and easy. All fixings included.



First door leaf can be left-hand or right-hand swing. The door split can be 1/2 : 1/2, 1/3 : 2/3 or any other reasonable proportion.



Raised threshold made of zinc coated rectangular steel tube. Rubber sealing.

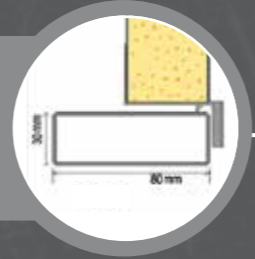

Zinc coated, robust and maintenance free steel frame. Painted same colour as the door or different if specified.

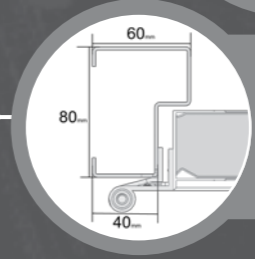

Flat threshold made of zinc coated steel tape. Brush sealing.

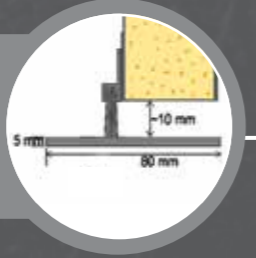

Energy efficient insulated door panels. Double steel skin filled with freon free PU foam: 1- 40mm thick foam; 2- steel; 3- zinc; 4- primer; 5- finish coating; 6- colour.

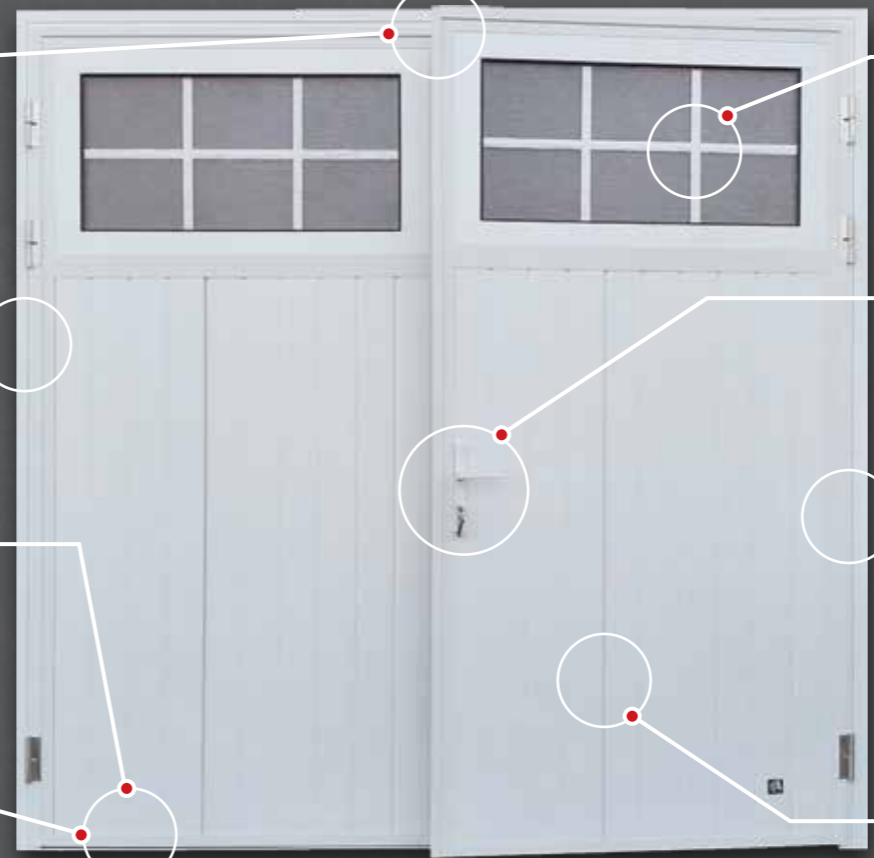
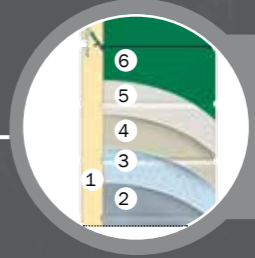

Additional options

ESPAGNOLETTE LOCK

Second leaf has espagnolette lock to keep it in closed position. Designed to make opening the second door leaf effortless.

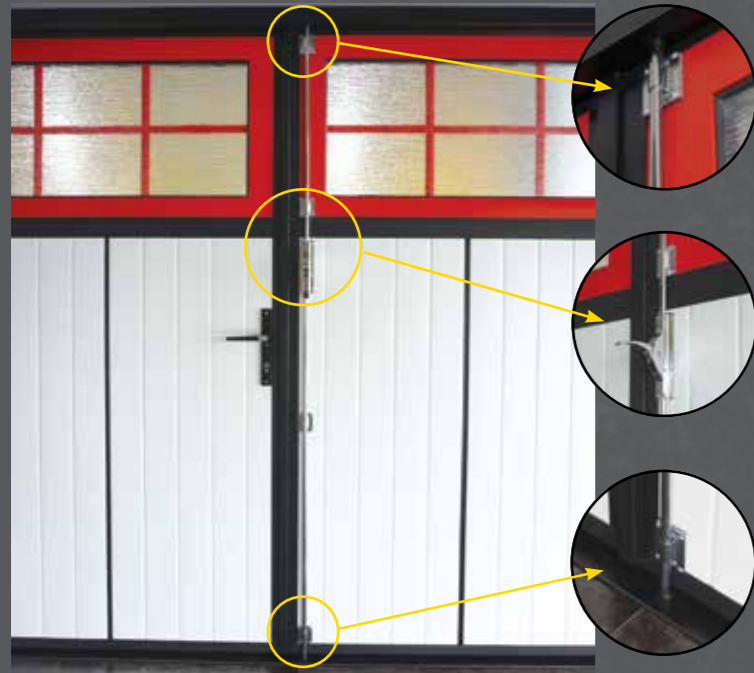

HANDLE OPTIONS

Locks – white, black, aluminium are the standard choice although other colours are available as an option.

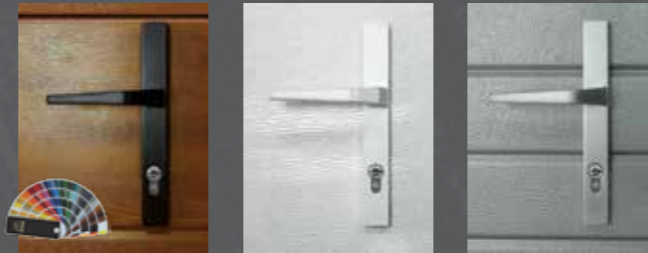

VENTILATION GRILL

Doors can be equipped with ventilation grills 338 x 132 mm. Standard colours white, black, brown. Painted custom, colours as additional option.

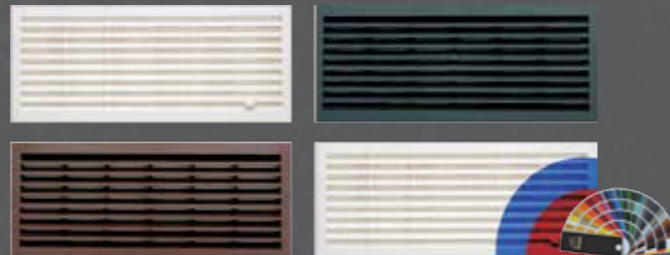

FRAME MOULDINGS

This option allows door to be fitted flush with the front wall hiding any small gaps or distressed brickwork. Same colour as frame. On left side frame with moulding on right - without moulding.



with moulding



without moulding

DOOR STAYS

Door stays keeps door leaf in open position.



Adjustable leaf opening angle 90-140 degrees.

THRESHOLD

Three options: L-shape (S1), rectangular (S3) and flat (S4).

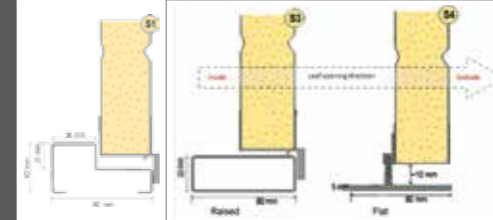

FRAME PROFILE CROSS-CUT

As standard -same colour as door. On request can be painted any colour. Frame's (without moulding) outer size is 10 mm less than structural opening width and 10 mm less than structural opening height.

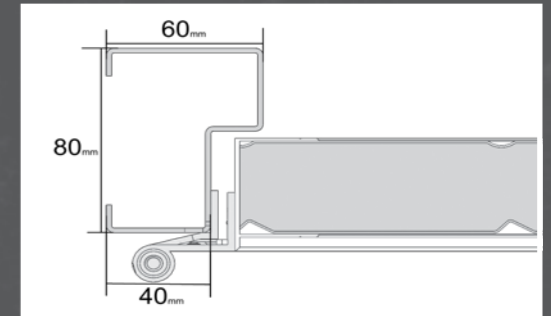

Easy and fast installation



Windows

DOUBLE GLAZED ALUMINIUM PANEL

Painted any colour (can be different from door colour).
Scratch-proof double glazing can be clear, matt, "frosted" or tinted. "Cross" decoration available – same as panel colour.

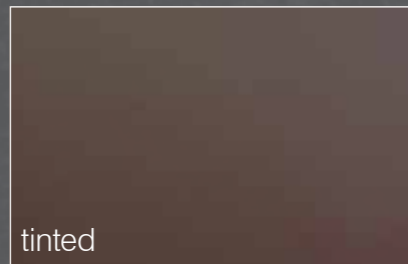
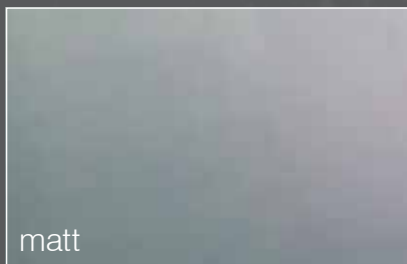

Polycarbonate (25 mm, white, brown, green) glazing.



STAINLESS STEEL WINDOWS:

SQUARES

MAXI 315 x 315 mm
MIDI 235 x 235 mm
MINI 155 x 155 mm



805 x 155 mm
window with triplex double glazing.

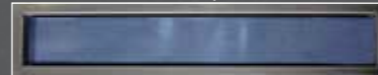

Window frame painted any colour.



PORTHOLES

MAXI Ø 315 mm
MIDI Ø 235 mm
MINI Ø 155 mm



PLASTIC WINDOWS:

44 x 28 cm (black/white)
frame, scratch proof double
glazing.



Decor (Sunrise, Cross)
for plastic windows



Fitting and opening option

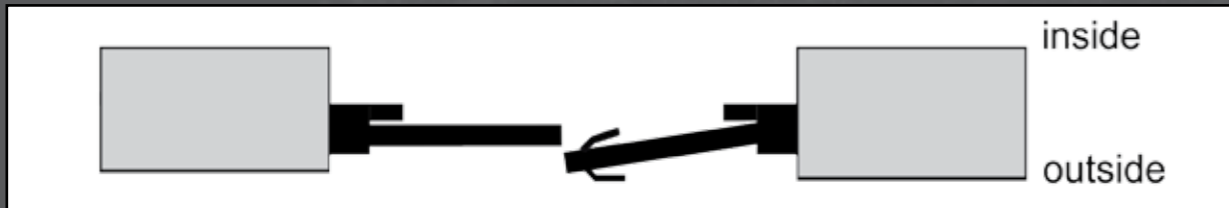
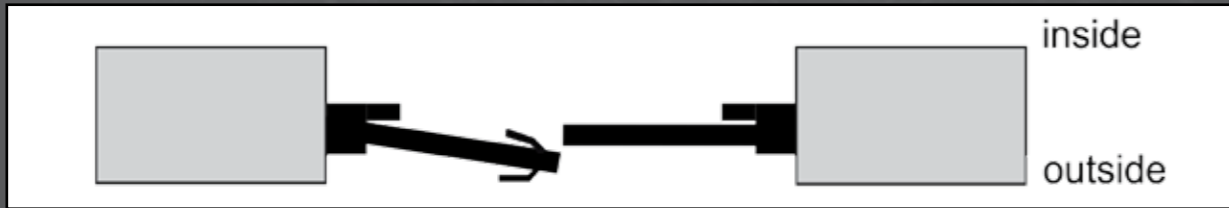
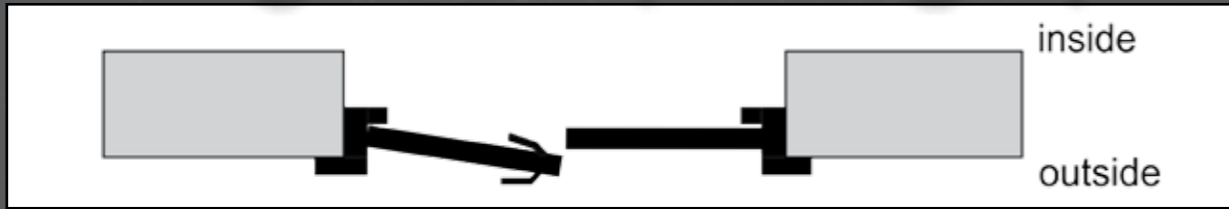

PET FLAP



Garage door can be equipped with pet flap. For necessary size and price consult manufacturer.

MAIL BOX



Have garage door facing the street - mail box can be an option.

VENTILATED



Doors with perforated steel sheets to ensure necessary air circulation where necessary.

www.ryternagaragedoors.co.uk
www.ryterna.eu

