



# Series 2000 Garage Door Price List

17.10.2016

**HÖRMANN**



## HÖRMANN IS ALWAYS COMMITTED TO EXCELLENCE: “In Engineering, in User Safety and in Design.”

All our products are third party tested to the highest standards and are certified to the high safety requirements and performance characteristics of the European Standard 13241-1.

This gives you the reassurance that your purchase of a Hörmann product is a safe investment. We are also committed to our national network of Garage Door Specialist Distributors.

These are independent businesses, who believe in customer service and have skills to advise you on the best product for your property, also providing quality fitting and finishing.

**“A great product performs at its best when fitted by experts.”**

### Door Operating Systems

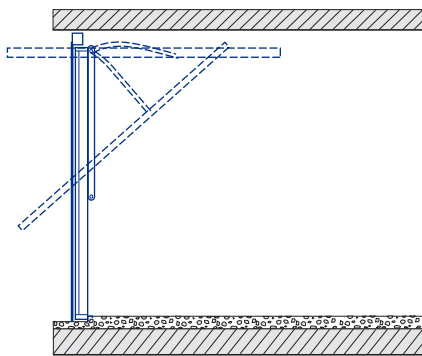

Canopy Operating Gear

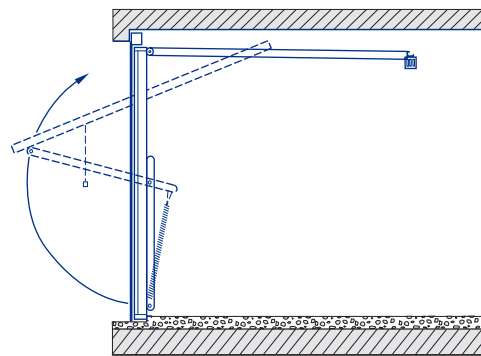

Retractable Operating Gear

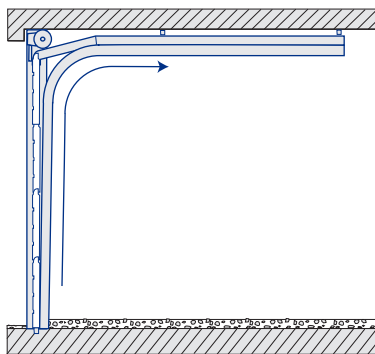

Sectional Operating Gear

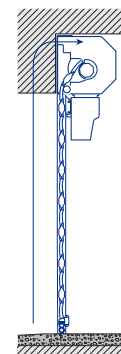

RollMatic Operating Gear

We reserve the right to change specification without prior notification.

# Contents



## Up-and-over garage doors

Canopy and retractable with steel infill	4
Canopy and retractable with timber infill	8
Canopy and retractable with GRP infill (Glass reinforced polyester)	12



## Sectional garage doors

Sectional Garage Doors LTE 40 Single-skinned steel Sectional doors	14
Sectional Garage Doors LPU 40 Double-skinned steel Sectional doors	15
Optional extras and window designs	18



## Sectional double-leaf side doors

Sectional double-leaf side doors with block frames made of aluminium profiles	20
---	----



## RollMatic roller garage doors

RollMatic Roller Garage Doors	22
RollMatic TDL Roller Garage Doors	27





## Garage door operators

Garage door operators	28
Operator accessories	28
<b>// NEW</b> HS 4 BS textured surface hand transmitter	
<b>// NEW</b> Walker/wheelchair hand transmitter holder	
<b>// NEW</b> Hand transmitter station with textured surface	
<b>// NEW</b> HSE 4 BS textured surface hand transmitter with chrome caps	
<b>// NEW</b> HSE 4 BS textured surface hand transmitter with plastic caps	



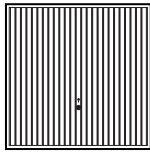
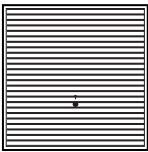
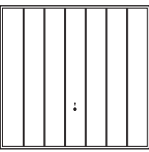
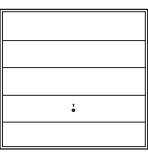

# Hörmann Up-and-Over Doors

## Canopy & retractable with steel infill

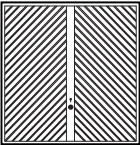

SINGLE DOORS													
Door sizes BR		2001 Vertical		2002 Horizontal		2601 Elegance		2602 Finesse		2101 Ilkley		2103 Caxton	
Imperial	Metric	CAN.	RET.	CAN.	RET.	CAN.	RET.	CAN.	RET.	CAN.	RET.	CAN.	RET.
6'6" x 6'6"	1981 x 1981	576	617	505	546								
7'0"	1981 x 2134	576	617	505	546								
6'10" x 6'4"	2083 x 1930	575	616	518	559								
6'6"	2083 x 1981	575	616	530	571								
7'0"	2083 x 2134	589	630	549	590								
7'0" x 6'4"	2134 x 1930	577 <sup>1</sup>	618 <sup>1</sup>	524	565					963	1004		
6'6"	<b>2134 x 1981</b>	<b>561<sup>1</sup></b>	<b>602<sup>1</sup></b>	<b>475<sup>1</sup></b>	<b>516<sup>1</sup></b>	<b>712</b>	<b>753</b>	<b>712</b>	<b>753</b>	<b>963</b>	<b>1004</b>	<b>929</b>	<b>970</b>
7'0"	<b>2134 x 2134</b>	<b>582<sup>1</sup></b>	<b>623<sup>1</sup></b>	<b>531<sup>1</sup></b>	<b>572<sup>1</sup></b>	<b>752</b>	<b>793</b>	<b>752</b>	<b>793</b>	<b>974</b>	<b>1015</b>	<b>936</b>	<b>977</b>
7'6"	2134 x 2286		718		670								
7'3" x 6'4"	2210 x 1930	606 <sup>1</sup>	647 <sup>1</sup>	570	611								
6'6"	2210 x 1981	609	650	573	614								
7'0"	2210 x 2134	617	658	579	620								
7'5" x 6'6"	2261 x 1981	614	655	570	611					1000	1041		
7'0"	2261 x 2134	689	730	650	691					1011	1052		
7'6" x 6'4"	2286 x 1930	627	668	570	611					1000	1041		
6'6"	2286 x 1981	627 <sup>1</sup>	668 <sup>1</sup>	570 <sup>1</sup>	611 <sup>1</sup>	790	831	790	831	1000	1041	984	1025
7'0"	2286 x 2134	689 <sup>1</sup>	730 <sup>1</sup>	652 <sup>1</sup>	693 <sup>1</sup>	911	952	911	952	1011	1052	994	1035
7'6"	2286 x 2286		781		803								
7'8" x 6'4"	2337 x 1930	711	752	656	697								
8'0" x 6'4"	2438 x 1930	744	785	657	698					1061	1102		
6'6"	2438 x 1981	744 <sup>1</sup>	785 <sup>1</sup>	657	698	936	977	936	977	1061	1102	1019	1060
7'0"	2438 x 2134	770 <sup>1</sup>	811 <sup>1</sup>	670	711	974	1015	974	1015	1071	1112	1070	1111
7'6"	2438 x 2286		879		782								
8'0"	2438 x 2438		910		814								
8'6" x 6'6"	2590 x 1981		847		752								
7'0"	2590 x 2134		918		779								
9'0" x 6'6"	2743 x 1981		978		937								
7'0"	2743 x 2134		1068		983								
10'0" x 6'6"	3048 x 1981		1185		1174								
7'0"	3048 x 2134		1185		1174								
<b>Prices Marked <sup>1</sup> – optional Terra brown RAL 8028 available. Surcharge on door, see page 7.</b>													
DOUBLE DOORS Internal frame sizes BR		2001 Vertical		2002 Horizontal		2601 Elegance		2602 Finesse		2101 Ilkley		Style Not Available	
Imperial	Metric	Retractable		Retractable		Retractable		Retractable		Retractable			
11'0" x 6'6"	3353 x 1981	1288 *		1288 *									
7'0"	3353 x 2134	1298 *		1298 *									
12'0" x 6'6"	3658 x 1981	1353 *		1353 *									
7'0"	3658 x 2134	1363 *		1363 *									
13'0" x 6'6"	3962 x 1981	1473 *		1473 *									
7'0"	3962 x 2134	1505 *		1505 *									
14'0" x 6'6"	4267 x 1981	1418		1418						1963*			
7'0"	4267 x 2134	1418		1418						1963*			
<b>Prices Marked * – Not available ex-stock, delivery 4 – 5 weeks</b>													
MATCHING SIDE DOORS Ordering sizes		2001 Vertical		2002 Horizontal		2601 Elegance		2602 Finesse		Style Not Available		Style Not Available	
875 x 1875													
875 x 2000		387		778 <sup>2</sup>		727 <sup>2</sup>		727 <sup>2</sup>					
875 x 2125													
1000 x 2000													
1000 x 2125		411		804 <sup>2</sup>		830 <sup>2</sup>		830 <sup>2</sup>					



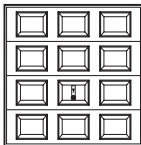

										75mm steel framed doors Recommended structural opening sizes allowing tolerance of 10mm on width & 5mm on height For steel frame options see page 7	
CAN.	RET.	CAN.	RET.	CAN.	RET.	CAN.	RET.	CAN.	RET.	Imperial	Metric
		703	744							7'0" x 6'8½"	2135 x 2044
		714	755							7'0" x 7'2¾"	2135 x 2199
		711	752							7'4" x 6'6½"	2235 x 1994
		712	753							7'4" x 6'8½"	2235 x 2044
		764	805							7'4" x 7'2¾"	2235 x 2199
		712	753							7'6" x 6'6½"	2284 x 1994
<b>599</b>	<b>640</b>	<b>712¹</b>	<b>753¹</b>	<b>978</b>	<b>1019</b>	<b>712</b>	<b>753</b>	<b>712</b>	<b>753</b>	<b>7'6" x 6'8½"</b>	<b>2284 x 2044</b>
<b>638</b>	<b>679</b>	<b>752¹</b>	<b>793¹</b>	<b>1019</b>	<b>1060</b>	<b>752</b>	<b>793</b>	<b>752</b>	<b>793</b>	<b>7'6" x 7'2¾"</b>	<b>2284 x 2199</b>
										7'6" x 7'8½"	2284 x 2350
		790	831							7'9¼" x 6'6½"	2365 x 1994
										7'9¼" x 6'8½"	2365 x 2044
										7'9¼" x 7'2¾"	2365 x 2199
		790	831							7'11" x 6'8½"	2411 x 2044
		911	952							7'11" x 7'2¾"	2411 x 2199
		790	831							8'0" x 6'6½"	2436 x 1994
667	708	790¹	831¹	1056	1097	790	831	790	831	8'0" x 6'8½"	2436 x 2044
		911¹	952¹	1177	1218	911	952	911	952	8'0" x 7'2¾"	2436 x 2199
										8'0" x 7'8½"	2436 x 2350
		948	989							8'2" x 6'6½"	2489 x 1994
		936	977							8'6" x 6'6½"	2589 x 1994
838	879	936	977			936	977			8'6" x 6'8½"	2589 x 2044
873	914	974	1015			974	1015			8'6" x 7'2¾"	2589 x 2199
										8'6" x 7'8½"	2589 x 2350
										8'6" x 8'2¾"	2589 x 2503
										9'0" x 6'8½"	2741 x 2044
										9'0" x 7'2¾"	2741 x 2199
			1233							9'6" x 6'8½"	2894 x 2044
			1255							9'6" x 7'2¾"	2894 x 2199
										10'6" x 6'8½"	3199 x 2044
										10'6" x 7'2¾"	3199 x 2199
2003 Chevron	2004 Georgian	2304 Georgian with windows	2104 Marquess	Style Not Available						Imperial	Metric
Retractable	Retractable	Retractable	Retractable								
										11'6" x 6'8½"	3504 x 2044
										11'6" x 7'2¾"	3504 x 2199
										12'6" x 6'8½"	3809 x 2044
										12'6" x 7'2¾"	3809 x 2199
										13'6" x 6'8½"	4114 x 2044
										13'6" x 7'2¾"	4114 x 2199
1862*	1527	2062*	1527*							14'6" x 6'8½"	4419 x 2044
1862*	1527	2062*	1527*							14'6" x 7'2¾"	4419 x 2199
2003 Chevron	2004 Georgian	2304 Georgian with windows	2104 Marquess	Style Not Available							
976²	727²	842²	727²								
992²	830²	945²	830²								

# Hörmann Up-and-Over Doors

## Canopy & retractable with steel infill

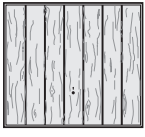
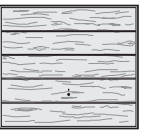

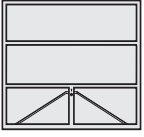
SINGLE DOORS											
Door sizes BR		Vertical Decograin Golden Oak or Rosewood		Horizontal Decograin Golden Oak or Rosewood		Georgian Decograin Golden Oak or Rosewood		Marquess Decograin Golden Oak or Rosewood		2011 Open for infill	
Imperial	Metric	CAN.	RET.	CAN.	RET.	CAN.	RET.	CAN.	RET.	CAN.	RET.
6'6" x 6'6"	1981 x 1981									487	528
7'0"	1981 x 2134									487	528
6'10" x 6'4"	2083 x 1930									487	528
6'6"	2083 x 1981										
7'0"	2083 x 2134										
7'0" x 6'4"	2134 x 1930									487	528
6'6"	<b>2134 x 1981</b>	<b>723</b>	<b>764</b>	<b>643</b>	<b>684</b>	<b>852</b>	<b>893</b>	<b>852</b>	<b>893</b>	487	528
7'0"	<b>2134 x 2134</b>	<b>744</b>	<b>785</b>	<b>696</b>	<b>737</b>	<b>893</b>	<b>934</b>	<b>893</b>	<b>934</b>	518	559
7'6"	2134 x 2286										
7'3" x 6'4"	2210 x 1930									542	583
6'6"	2210 x 1981										
7'0"	2210 x 2134										
7'5" x 6'6"	2261 x 1981	771	812	712	753					542	583
7'0"	2261 x 2134	830	871	793	834					558	599
7'6" x 6'4"	2286 x 1930									542	583
6'6"	2286 x 1981	771	812	712	753	948	989	948	989	542	583
7'0"	2286 x 2134	830	871	793	834	1095	1136	1095	1136	557	598
7'6"	2286 x 2286										
7'8" x 6'4"	2337 x 1930									566	607
8'0" x 6'4"	2438 x 1930									566	607
6'6"	2438 x 1981	888	929	786	827	1113	1154	1113	1154	566	607
7'0"	2438 x 2134	914	955	815	856	1152	1193	1152	1193	566	607
7'6"	2438 x 2286										
8'0"	2438 x 2438										
8'6" x 6'6"	2590 x 1981										
7'0"	2590 x 2134										
9'0" x 6'6"	2743 x 1981										669
7'0"	2743 x 2134										680
10'0" x 6'6"	3048 x 1981										827
7'0"	3048 x 2134										827
DOUBLE DOORS Internal frame sizes BR		Style Not Available		Style Not Available		Style Not Available		Style Not Available		2011 Open for infill	
Imperial	Metric									Retractable	
11'0" x 6'6"	3353 x 1981										1632
7'0"	3353 x 2134										1705
12'0" x 6'6"	3658 x 1981										1728
7'0"	3658 x 2134										1793
13'0" x 6'6"	3962 x 1981										1814
7'0"	3962 x 2134										1872
14'0" x 6'6"	4267 x 1981										1695
7'0"	4267 x 2134										1695
<b>Prices Marked * – Not available ex-stock, delivery 4–5 weeks</b>											
MATCHING SIDE DOORS Ordering sizes		2001 Golden Oak or Rosewood		2002 Golden Oak or Rosewood		2004 Golden Oak or Rosewood		2104 Golden Oak or Rosewood		2011 Open for infill	
<b>Prices Marked <sup>2</sup> – Not available ex-stock, delivery 4–8 weeks</b>											
875 x 1875											
875 x 2000		804 <sup>2</sup>		804 <sup>2</sup>		804 <sup>2</sup>		804 <sup>2</sup>			387
875 x 2125											
1000 x 2000											
1000 x 2125		923 <sup>2</sup>		923 <sup>2</sup>		923 <sup>2</sup>		923 <sup>2</sup>			411





The door leaf and optional box section steel frame are made of galvanised material that is polyester powder coated on both sides.

This finish is extremely durable and the standard colour is Traffic white RAL 9016.

Other colours are available listed in optional extras below.

To help maintain the aesthetic appearance of your door and prevent the build up of dirt, salt and other corrosive substances the door should be washed with a mild soap-based solution on a regular basis.

If the door is located near the coast it is important that the door panel and frame should be washed at least every 2 months.

We also suggest that all other components are brushed down on a regular basis to prevent the build up of dirt and dust etc.

The window frames on the Georgian and Ilkley doors are UPVC and white as standard.

These frames are a 2-part construction with the window material sandwiched between and frames screwed together from the back for security.

The finish of the Decograin doors is a synthetic foil-coated timber design outside (inside primer white).

The leaf frame and fixing frame is a matching powder coating.

**For further choice of exciting door designs in steel, traditional or contemporary, with a vast range of sizes and increased range of colours, ask your garage door specialist about the N 80 Up-and-Over garage doors available to special order.**

Optional extras for Steel Doors	Price
<b>75mm</b> Steel fixing frame for either canopy or retractable geared single doors. Factory fitted	<b>105</b>
<b>75mm</b> Steel fixing frame for either canopy or retractable geared single doors. Factory fitted with frame to compliment Decograin	<b>105</b>
<b>75mm</b> Steel fixing frame for <b>DOUBLE</b> retractable geared doors, when ordered with the door	<b>166</b>
<b>60mm</b> Steel fixing frame for canopy geared doors only. Factory fitted	<b>109</b>
<b>60mm</b> Steel fixing frame for canopy geared doors only. Factory fitted with frame to compliment Decograin	<b>109</b>
<b>Please note:</b> Factory fitted 8' high frame not available	
Prices marked <sup>1</sup> – optional Terra Brown RAL 8028 available. Surcharge on door	<b>29</b>
Retractable plus gear for retractable doors up to 7'6" wide giving extra drive through width	
Surcharge on retractable price	<b>54</b>
4 point locking kit for extra security, factory fit with door order or retrofit – single door sizes only	<b>49</b>
3 point locking kit for extra security, factory fit with door (this cannot be retrofitted). Available for 2001 side doors only	<b>97</b>
Window options for 2304 Georgian style door – Plain, crossed or diamond style with crystal glazing	<b>Incl.</b>
<b>Colours are available to special order in the following styles:</b>	
2001 Vertical, 2002 Horizontal, 2101 Ilkley available in all the listed sizes	
2004 Georgian, 2304 Georgian with windows and 2104 Marquess are available in	
7066, 7070, 7566, 7570, 7666, 7670 and 8066, 8070 sizes only	
<b>Please note:</b> Caxton, Chevron, Elegance, Finesse and Countess steel up-and-over doors are only available in white	
<b>Colours:</b>	
Terra Brown RAL 8028, Signal Blue RAL 5005, Steel Blue RAL 5011, Moss Green RAL 6005, Ruby Red RAL 3003, Jet Black RAL 9005	
Includes matching frame if ordered with door. White frame RAL 9016 also available, please specify when ordering	
Please allow 3–4 weeks lead time for coloured doors	
	Single doors <b>100</b>
	Double doors <b>161</b>
<b>Coloured window frames for Georgian and Ilkley doors:</b>	
Coloured window frames to match door colour	
Georgian doors (price per window, see note below for the number of windows)	<b>30</b>
Ilkley doors (price per single door)	<b>142</b>
Ilkley doors (price per double door)	<b>280</b>
Please state coloured windows required on order	
Orders received without reference will be supplied with white as standard	
Georgian doors up to 10' wide = 4 windows, 11' to 13' = 6 windows, 14' = 8 windows	
<b>Optional handle sets</b>	
Cast Aluminium silver colour and brass colour	<b>118</b>
Cast Aluminium white and brown	<b>142</b>
Brushed or polished stainless steel	<b>171</b>
Matching lever handles are also available for side doors	<b>P.O.A.</b>

# Hörmann Up-and-Over Doors



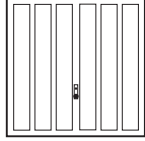
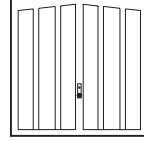
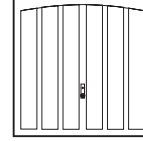
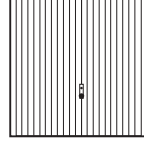

## Canopy & retractable with timber infill



SINGLE DOORS											
Door sizes BR		2005 Measham		2007 Jacobean		2008 Tudor		2014 Rutland		2009 Vertical or Horizontal	
Imperial	Metric	CAN.	RET.	CAN.	RET.	CAN.	RET.	CAN.	RET.	CAN.	RET.
6'6" x 6'6"	1981 x 1981	1040	1081	1255	1296	1255	1296	1255	1296	1433	1474
7'0"	1981 x 2134	1040	1081	1255	1296	1255	1296	1255	1296	1433	1474
6'10" x 6'4"	2083 x 1930	1040	1081	1255	1296	1255	1296	1255	1296	1433	1474
6'6"	2083 x 1981										
7'0"	2083 x 2134										
7'5" x 6'4"	2134 x 1930	1040	1081	1255	1296	1255	1296	1255	1296	1433	1474
6'6"	<b>2134 x 1981</b>	<b>1040</b>	<b>1081</b>	<b>1255</b>	<b>1296</b>	<b>1255</b>	<b>1296</b>	<b>1255</b>	<b>1296</b>	<b>1433</b>	<b>1474</b>
7'0"	<b>2134 x 2134</b>	<b>1040</b>	<b>1081</b>	<b>1255</b>	<b>1296</b>	<b>1255</b>	<b>1296</b>	<b>1255</b>	<b>1296</b>	<b>1433</b>	<b>1474</b>
7'6"	2134 x 2286										
7'3" x 6'4"	2210 x 1930	1081	1122	1314	1355	1314	1355	1314	1355	1485	1526
6'6"	2210 x 1981										
7'0"	2210 x 2134										
7'5" x 6'6"	2261 x 1981	1081	1122	1314	1355	1314	1355	1314	1355	1485	1526
7'0"	2261 x 2134	1163	1204	1356	1397	1356	1397	1356	1397	1520	1561
7'6" x 6'4"	2286 x 1930	1081	1122	1314	1355	1314	1355	1314	1355	1485	1526
6'6"	2286 x 1981	1081	1122	1314	1355	1314	1355	1314	1355	1485	1526
7'0"	2286 x 2134	1107	1148	1356	1397	1356	1397	1356	1397	1520	1561
7'6"	2286 x 2286										
8'0"	2286 x 2438										
7'8" x 6'4"	2337 x 1930	1123	1164	1373	1414	1373	1414	1373	1414	1485	1526
8'0" x 6'4"	2438 x 1930	1142	1183	1388	1429	1388	1429	1388	1429	1571	1612
6'6"	2438 x 1981	1142	1183	1388	1429	1388	1429	1388	1429	1571	1612
7'0"	2438 x 2134	1166	1207	1423	1464	1423	1464	1423	1464	1616	1657
8'0"	2438 x 2438										
8'6" x 6'6"	2590 x 1981										
7'0"	2590 x 2134										
9'0" x 6'6"	2743 x 1981		1386		1607		1607		1607		1716
7'0"	2743 x 2134		1386		1607		1607		1607		1716
10'0" x 6'6"	3048 x 1981		1391		1717		1717		1717		1794
7'0"	3048 x 2134		1391		1717		1717		1717		1794
DOUBLE DOORS Internal frame sizes BR		2005 Measham		2007 Jacobean		2008 Tudor		2014 Rutland		2009 Vertical or Horizontal	
Imperial	Metric	CAN.	RET.	CAN.	RET.	CAN.	RET.	CAN.	RET.	CAN.	RET.
11'0" x 6'6"	3353 x 1981		2454		2707		2707		2707		2891
7'0"	3353 x 2134		2454		2707		2707		2707		2891
12'0" x 6'6"	3658 x 1981		2546		2720		2720		2720		3196
7'0"	3658 x 2134		2546		2720		2720		2720		3196
13'0" x 6'6"	3962 x 1981		2556		2934		2934		2934		3573
7'0"	3962 x 2134		2556		2934		2934		2934		3573
14'0" x 6'6"	4267 x 1981		2561		2888		2888		2888		2993
7'0"	4267 x 2134		2561		2888		2888		2888		2993
<b>Please note: Lead times on all timber garage doors will be 5 to 6 weeks</b>											
MATCHING SIDE DOORS Ordering sizes		2005 Measham		2007 Jacobean		2008 Tudor		2014 Rutland		2009 Vertical or Horizontal	
Imperial	Metric	CAN.	RET.	CAN.	RET.	CAN.	RET.	CAN.	RET.	CAN.	RET.
875 x 1875											
875 x 2000		703		814		814		814		823	
875 x 2125											
1000 x 2000											
1000 x 2125		739		848		848		848		860	

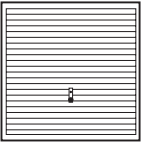



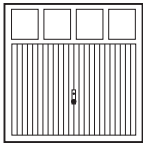



										75mm steel framed doors Recommended structural opening sizes allowing tolerance of 10mm on width & 5mm on height For steel frame options see page 11	
CAN.	RET.	CAN.	RET.	CAN.	RET.	CAN.	RET.	CAN.	RET.	Imperial	Metric
1430	1471	1660	1701	1660	1701	1660	1701	1715	1756	7'0" x 6'8½"	2135 x 2044
1430	1471	1660	1701	1660	1701	1660	1701	1715	1756	7'0" x 7'2¾"	2135 x 2199
1430	1471	1660	1701	1660	1701	1660	1701	1715	1756	7'4" x 6'6½"	2235 x 1994
										7'4" x 6'8½"	2235 x 2044
										7'4" x 7'2¾"	2235 x 2199
1430	1471	1660	1701	1660	1701	1660	1701	1715	1756	7'6" x 6'6½"	2284 x 1994
1430	1471	1660	1701	1660	1701	1660	1701	1715	1756	7'6" x 6'8½"	2284 x 2044
1430	1471	1660	1701	1660	1701	1660	1701	1715	1756	7'6" x 7'2¾"	2284 x 2199
										7'6" x 7'8½"	2284 x 2350
1485	1526	1713	1754	1713	1754	1713	1754	1790	1831	7'9¼" x 6'6½"	2365 x 1994
										7'9¼" x 6'8½"	2365 x 2044
										7'9¼" x 7'2¾"	2365 x 2199
1485	1526	1713	1754	1713	1754	1713	1754	1790	1831	7'11" x 6'8½"	2411 x 2044
1541	1582	1740	1781	1740	1781	1740	1781	1836	1877	7'11" x 7'2¾"	2411 x 2199
1485	1526	1713	1754	1713	1754	1713	1754	1790	1831	8'0" x 6'6½"	2436 x 1994
1485	1526	1713	1754	1713	1754	1713	1754	1790	1831	8'0" x 6'8½"	2436 x 2044
1541	1582	1740	1781	1740	1781	1740	1781	1874	1915	8'0" x 7'2¾"	2436 x 2199
										8'0" x 7'8½"	2436 x 2350
										8'0" x 8'2¾"	2436 x 2503
1634	1675	1878	1919	1878	1919	1878	1919	2009	2050	8'2" x 6'6½"	2489 x 1994
1634	1675	1878	1919	1878	1919	1878	1919	2009	2050	8'6" x 6'6½"	2589 x 1994
1634	1675	1878	1919	1878	1919	1878	1919	2009	2050	8'6" x 6'8½"	2589 x 2044
1634	1675	1878	1919	1878	1919	1878	1919	2009	2050	8'6" x 7'2¾"	2589 x 2199
										8'6" x 8'2¾"	2589 x 2503
										9'0" x 6'8½"	2741 x 2044
										9'0" x 7'2¾"	2741 x 2199
	1885		2151		2151		2151		2210	9'6" x 6'8½"	2894 x 2044
	1885		2151		2151		2151		2210	9'6" x 7'2¾"	2894 x 2199
	2055		2289		2289		2289		2456	10'6" x 6'8½"	3199 x 2044
	2055		2289		2289		2289		2456	10'6" x 7'2¾"	3199 x 2199
2109 Mallory		2013 Caxton		2020 Gatcombe		2114 Shepshed		2019 Garage Light		Imperial	Metric
CAN.	RET.	CAN.	RET.	CAN.	RET.	CAN.	RET.	CAN.	RET.		
	3041		3212		3212		3212		3575	11'6" x 6'8½"	3504 x 2044
	3041		3212		3212		3212		3575	11'6" x 7'2¾"	3504 x 2199
	3299		3492		3492		3492		3932	12'6" x 6'8½"	3809 x 2044
	3299		3492		3492		3492		3932	12'6" x 7'2¾"	3809 x 2199
	3579		3816		3816		3816		4428	13'6" x 6'8½"	4114 x 2044
	3579		3816		3816		3816		4428	13'6" x 7'2¾"	4114 x 2199
	3476		3711		3711		3711		4196	14'6" x 6'8½"	4419 x 2044
	3476		3711		3711		3711		4196	14'6" x 7'2¾"	4419 x 2199
2109 Mallory		2013 Caxton		2020 Gatcombe		2114 Shepshed		2019 Garage Light			
	928		960		980		955		1094		
	966		998		1019		991		1128		

# Hörmann Up-and-Over Doors

## Canopy & retractable with timber infill

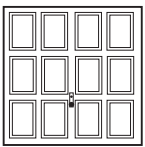

SINGLE DOORS										75mm steel framed doors Recommended structural opening sizes allowing tolerance of 10mm on width & 5mm on height For steel frame options see page 11	
Door sizes BR		2119 Leicester		2010 Chevron		2121 Chesterfield		2122 Middleton		Imperial	Metric
Imperial	Metric	CAN.	RET.	CAN.	RET.	CAN.	RET.	CAN.	RET.		
6'6" x 6'6"	1981 x 1981		1983	1772	1813		2266		2247	7'0" x 6'8½"	2135 x 2044
7'0"	1981 x 2134		1983	1772	1813		2266		2247	7'0" x 7'2¾"	2135 x 2199
6'10" x 6'4"	2083 x 1930		1983	1772	1813		2266		2247	7'4" x 6'6½"	2235 x 1994
6'6"	2083 x 1981									7'4" x 6'8½"	2235 x 2044
7'0"	2083 x 2134									7'4" x 7'2¾"	2235 x 2199
7'0" x 6'4"	2134 x 1930		1998	1772	1813		2266		2247	7'6" x 6'6½"	2284 x 1994
6'6"	<b>2134 x 1981</b>		<b>1998</b>	<b>1772</b>	<b>1813</b>		<b>2266</b>		<b>2247</b>	<b>7'6" x 6'8½"</b>	<b>2284 x 2044</b>
7'0"	<b>2134 x 2134</b>		<b>1998</b>	<b>1772</b>	<b>1813</b>		<b>2282</b>		<b>2273</b>	<b>7'6" x 7'2¾"</b>	<b>2284 x 2199</b>
7'6"	2134 x 2286									7'6" x 7'8½"	2284 x 2350
7'3" x 6'4"	2210 x 1930		2179	1851	1892		2433		2425	7'9¼" x 6'6½"	2365 x 1994
6'6"	2210 x 1981									7'9¼" x 6'8½"	2365 x 2044
7'0"	2210 x 2134									7'9¼" x 7'2¾"	2365 x 2199
7'5" x 6'6"	2261 x 1981		2189	1851	1892		2437		2425	7'11" x 6'8½"	2411 x 2044
7'0"	2261 x 2134		2273	1902	1943		2448		2437	7'11" x 7'2¾"	2411 x 2199
7'6" x 6'4"	2286 x 1930		2187	1851	1892		2437		2425	8'0" x 6'6½"	2436 x 1994
6'6"	2286 x 1981		2187	1851	1892		2437		2425	8'0" x 6'8½"	2436 x 2044
7'0"	2286 x 2134		2273	1902	1943		2461		2448	8'0" x 7'2¾"	2436 x 2199
7'6"	2286 x 2286									8'0" x 7'8½"	2436 x 2350
8'0"	2286 x 2438									8'2" x 6'6½"	2436 x 2503
7'8" x 6'4"	2337 x 1930		2333	2022	2063					8'6" x 6'6½"	2489 x 1994
8'0" x 6'4"	2438 x 1930		2341	2022	2063					8'6" x 6'8½"	2589 x 1994
6'6"	2438 x 1981		2341	2022	2063					8'6" x 7'2¾"	2589 x 2044
7'0"	2438 x 2134		2393	2055	2096					8'6" x 7'8½"	2589 x 2199
8'0"	2438 x 2438									8'6" x 8'2¾"	2589 x 2503
8'6" x 6'6"	2590 x 1981									9'0" x 6'8½"	2741 x 2044
7'0"	2590 x 2134									9'0" x 7'2¾"	2741 x 2199
9'0" x 6'6"	2743 x 1981		2453		2231					9'6" x 6'8½"	2894 x 2044
7'0"	2743 x 2134		2453		2231					9'6" x 7'2¾"	2894 x 2199
10'0" x 6'6"	3048 x 1981		2763		2597					10'6" x 6'8½"	3199 x 2044
7'0"	3048 x 2134		2763		2597					10'6" x 7'2¾"	3199 x 2199
DOUBLE DOORS Internal Frame Sizes BR		2119 Leicester		2010 Chevron		Style Not Available		Style Not Available		Imperial	Metric
BR	RET.	CAN.	RET.	CAN.	RET.	CAN.	RET.	CAN.	RET.		
11'0" x 6'6"	3353 x 1981		3851		3686					11'6" x 6'8½"	3504 x 2044
7'0"	3353 x 2134		3851		3686					11'6" x 7'2¾"	3504 x 2199
12'0" x 6'6"	3658 x 1981		4118		3754					12'6" x 6'8½"	3809 x 2044
7'0"	3658 x 2134		4118		3754					12'6" x 7'2¾"	3809 x 2199
13'0" x 6'6"	3962 x 1981		4506		3816					13'6" x 6'8½"	4114 x 2044
7'0"	3962 x 2134		4506		3816					13'6" x 7'2¾"	4114 x 2199
14'0" x 6'6"	4267 x 1981		4396		3711					14'6" x 6'8½"	4419 x 2044
7'0"	4267 x 2134		4396		3711					14'6" x 7'2¾"	4419 x 2199
<b>Please note: Lead times on all timber garage doors will be 5 to 6 weeks</b>											
MATCHING SIDE DOORS Ordering Sizes		2119 Leicester		2010 Chevron		2121 Chesterfield		2122 Middleton			
<b>Please note: Lead times on all timber side garage doors will be 5 to 6 weeks</b>											
875 x 1875											
875 x 2000		838		814		814		838			
875 x 2125											
1000 x 2000		860		848		848		860			
1000 x 2125											



Our timber garage doors are constructed as an infill to fit into the Open-for-Infill Up-and-Over door frame, this gives the doors their rigid and durable construction.

The styles Measham, Jacobean, Tudor and Rutland are cedar facings glued and fixed to exterior quality plywood.

The solid cedar doors are 12mm tongue and groove boards constructed as an infill.

Cedar is organically grown with natural colour and grain variations; this is a feature of cedar.

We make every effort to harmonise the effect where possible, by hand matching the component parts used in construction.

Please note a uniform overall grain pattern cannot be guaranteed.

#### Protection (Basecoat)

All our timber doors are supplied with a dip immersion coat of Remmers Induline GW306 base stain primer 006 Light Oak; this coating is for temporary protection only.

If purchased in this temporary finish, please ensure that a full specification of finishing coats are applied immediately before or after installation to all exposed surfaces - inside as well as outside - with a Remmers or similar finishing coat system.

**A fully finished option is available, please see options below.**

**For further choice of exciting door designs, traditional or contemporary in Nordic Pine and Hemlock, with a vast range of sizes, ask your garage door specialist about the N80 Up-and-Over garage doors available to special order.**

Optional extras for timber doors	Price	
<b>75mm</b> Steel fixing frame for either canopy or retractable geared single doors, factory fitted Terra brown RAL 8028 as standard	<b>105</b>	
<b>75mm</b> Steel fixing frame for <b>DOUBLE</b> retractable geared doors Terra brown RAL 8028 as standard when ordered with the door	<b>166</b>	
<b>60mm</b> Steel fixing frame for canopy geared doors only, factory fitted Terra brown RAL 8028 as standard	<b>109</b>	
<b>Please note:</b> Factory fitted 8' high frame not available		
Retractable plus gear for retractable doors up to 7'6" wide giving extra drive through width Surcharge on retractable price	<b>54</b>	
4 point locking kit for extra security, factory fit with door order or retrofit	<b>49</b>	
Window options for 2019 Garage Light door - Crystal or clear glazing and can be plain or with square or diamond simulated leading	<b>Incl.</b>	
Over cladding of the OFI chassis (not available in combination with retractable plus)	<b>Single 70</b>	<b>Double 140</b>

#### Fully finished option

This is available as a factory process giving a 5 year erosion protection

The product used is Remmers and is available in the following stain colours:

Mahogany, Walnut, Dark Oak, Medium Oak, Light Oak, Teak, Ebony, Rosewood and Golden Oak

For south facing situations exposed to strong sunlight, the dark colours are NOT recommended as they can store excessive heat and dry out

	Stain finish	Traffic white RAL 9016	RAL to choose
Door sizes up to 8'0" x 7'0"	<b>107</b>	<b>184</b>	<b>245</b>
Door sizes up to 14'0" x 7'0"	<b>245</b>	<b>332</b>	<b>609</b>
Side Doors	<b>79</b>	<b>166</b>	<b>208</b>

#### Optional handle sets

Cast Aluminium silver colour and brass colour	<b>118</b>
Cast Aluminium white and brown	<b>142</b>
Brushed or polished stainless steel	<b>171</b>
Matching lever handles are also available for side doors	<b>P.O.A.</b>

# Hörmann Up-and-Over Doors

## Canopy & retractable with GRP infill

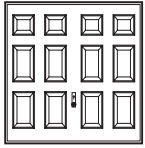
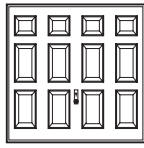
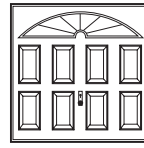
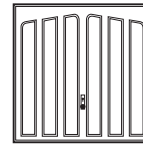
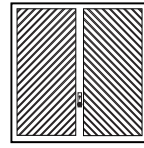

SINGLE DOORS											
Door sizes BR		2042 Windermere		2041 Coniston		2044 Stamford		2034 Penshurst		2035 Hartfield	
Imperial	Metric	CAN.	RET.	CAN.	RET.	CAN.	RET.	CAN.	RET.	CAN.	RET.
7'0" x 6'6"	2134 x 1981	1714	1755	1677	1718	1760	1801	1817	1858	1817	1858
7'0"	2134 x 2134	1714	1755	1677	1718	1760	1801	1817	1858	1817	1858
7'6" x 6'6"	2286 x 1981	1817	1858	1771	1812	1853	1894	1975	2016	1975	2016
7'0"	2286 x 2134	1817	1858	1771	1812	1853	1894	1975	2016	1975	2016
8'0" x 6'6"	2438 x 1981	1954	1995	1933	1974	2006	2047	2103	2144		
7'0"	2438 x 2134	1954	1995	1933	1974	2006	2047	2103	2144		
9'0" x 6'6"	2743 x 1981		2197*		2147*		2218*		2261		
7'0"	2743 x 2134		2197*		2147*		2218*		2261		

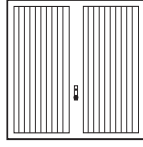
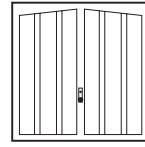
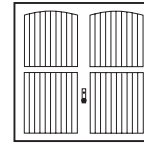
SINGLE DOORS & DOUBLE DOORS									
Door sizes BR		2040 Livingston		2047 Bourton		2048 Burford		2049 Moreton	
Imperial	Metric	CAN.	RET.	CAN.	RET.	CAN.	RET.	CAN.	RET.
7'0" x 6'6"	2134 x 1981	2009	2050	1817	1858	1817	1858	2009	2050
7'0"	2134 x 2134	2009	2050	1817	1858	1817	1858	2009	2050
7'6" x 6'6"	2286 x 1981	2169	2210	1975	2016	1975	2016	2169	2210
7'0"	2286 x 2134	2169	2210	1975	2016	1975	2016	2169	2210
8'0" x 6'6"	2438 x 1981			2103	2144	2103	2144	2294	2335
7'0"	2438 x 2134			2103	2144	2103	2144	2294	2335
14'0" x 6'6"	4267 x 1981				3327		3611		3626
7'0"	4267 x 2134				3327		3611		3626

Coniston and Stamford are supplied in white RAL 9016 OFI, all other styles are supplied in Terra brown RAL 8028 OFI.

### 75mm steel framed doors

Door sizes BR		Recommended structural opening sizes allowing tolerance of 10mm on width & 5mm on height	
Imperial	Metric	Imperial	Metric
7'0" x 6'6"	2134 x 1981	7'6" x 6'8½"	2284 x 2044
7'0" x 7'0"	2134 x 2134	7'6" x 7'2¾"	2284 x 2199
7'6" x 6'6"	2286 x 1981	8'0" x 6'8½"	2436 x 2044
7'6" x 7'0"	2286 x 2134	8'0" x 7'2¾"	2436 x 2199
8'0" x 6'6"	2438 x 1981	8'6" x 6'8½"	2589 x 2044
8'0" x 7'0"	2438 x 2134	8'6" x 7'2¾"	2589 x 2199
9'0" x 6'6"	2743 x 1981	9'6" x 6'8½"	2894 x 2044
9'0" x 7'0"	2743 x 2134	9'6" x 7'2¾"	2894 x 2199

For GRP colour options please consult main brochure

Window Options	Price
Clear or translucent	Per door 168
Clear or translucent with decorative leading	Per door 282

Windows are available in the Windermere and Coniston (clear or translucent) Stamford comes with black windows as standard  
\* Doors only available without handle (automation required)



## Door sizes

Large range of standard sizes is supplemented with intermediate widths and heights available by modification at Hörmann's UK headquarters. Please consult with your Hörmann UK specialist installer.

## Secured by design

- LPU40 sectional doors are certified SBD when fitted with a ProMatic or SupraMatic BiSecur operator
- A unique mechanical latch, integral to the operator boom engages automatically to make the door impossible to lever open
- Doors with windows and ventilation grilles, manually operated doors, or doors fitted between the opening are excluded from SBD certification
- Copies of SBD and test certification are available, if required, via the Hörmann UK Marketing Department

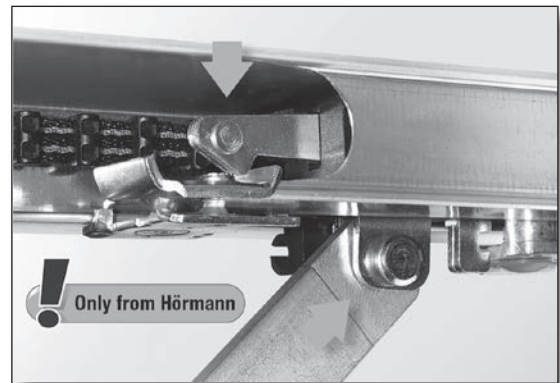

**For further information on Secured by Design see our brochure.**





# Hörmann Sectional Doors

## LTE 40 – single-skinned doors with steel sections

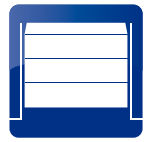
Single doors with Z track tension springs giving low headroom as standard

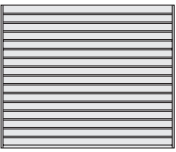

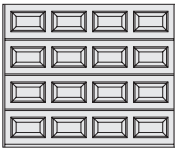
SINGLE DOORS								No. of panels
Door sizes BR		S-ribbed Woodgrain		M-ribbed Woodgrain		S-panelled Woodgrain		
Imperial	Metric	Outside White	Outside Colour	Outside White	Outside Colour	Outside White	Outside Colour	
6'10" x 6'2"	2080 x 1875	671	824	671	824	753	906	4
6'10"	2080 x 2080	703	872	703	872	779	948	4
7'0" x 6'6"	2134 x 2000	684	851	684	851	766	933	4
7'0"	2134 x 2125	703	880	703	880	779	956	4
7'6" x 6'6"	2286 x 2000	684	863	684	863	766	945	4
7'0"	2286 x 2125	703	893	703	893	779	969	4
7'4"	2286 x 2250	740	941	740	941	813	1014	4
7'9"	2286 x 2375	855	1067	855	1067	936	1148	4
8'2"	2286 x 2500	855	1078	855	1078	934	1157	4
8'0" x 6'6"	2438 x 2000	712	903	712	903	794	985	4
7'0"	2438 x 2125	738	941	738	941	808	1011	4
7'4"	2438 x 2250	776	990	776	990	843	1057	4
7'9"	2438 x 2375	890	1116	890	1116	963	1189	4
8'2"	2438 x 2500	888	1126	888	1126	963	1201	4
8'6" x 6'6"	2591 x 2000	712	915	712	915	794	997	4
7'0"	2591 x 2125	738	953	738	953	808	1023	4
9'0" x 6'6"	2740 x 2000	802	1016	802	1016	920	1134	4
7'0"	2740 x 2125	826	1054	826	1054	937	1165	4
9'6" x 6'6"	2896 x 2000	828	1054	828	1054	964	1190	5
7'0"	2896 x 2125	859	1100	859	1100	980	1221	5
10'0" x 6'6"	3048 x 2000	828	1066	828	1066	964	1202	5
7'0"	3048 x 2125	859	1112	859	1112	980	1233	5

For information on outside colour, see page 17

## Double doors with N track torsion springs (for low headroom see bottom of page 17)

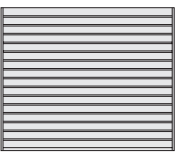
DOUBLE DOORS			
Door sizes BR		S-ribbed Woodgrain	
Imperial	Metric	Outside White	Outside Colour
11'0" x 6'6"	3353 x 2000	1156	1418
7'0"	3353 x 2125	1198	1476
12'0" x 6'6"	3658 x 2000	1277	1563
7'0"	3658 x 2125	1331	1635
13'0" x 6'6"	3962 x 2000	1305	1615
7'0"	3962 x 2125	1358	1687
14'0" x 6'6"	4267 x 2000	1415	1748
7'0"	4267 x 2125	1490	1844
14'6" x 6'6"	4420 x 2000	1446	1791
7'0"	4420 x 2125	1523	1890
15'0" x 6'6"	4572 x 2000	1454	1811
7'0"	4572 x 2125	1528	1907
15'6" x 6'6"	4725 x 2000	1497	1866
7'0"	4725 x 2125	1574	1966
16'0" x 6'6"	4877 x 2000	1496	1877
7'0"	4877 x 2125	1574	1979





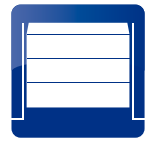

# Hörmann Sectional Doors

## LPU 40 – double-skinned doors with steel sections – 42mm

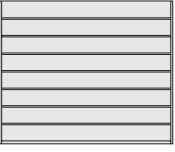

Single doors with Z track tension springs giving low headroom as standard



SINGLE DOORS									
Door sizes BR		S-ribbed Woodgrain/ M-ribbed Woodgrain		M-ribbed Sandgrain		M-ribbed Silkgrain		M-ribbed Decograin	
Imperial	Metric	Outside White	Outside Colour	Outside White	Anthracite grey Terra brown White aluminium	Outside White	Outside Colour	Rosewood, Golden Oak, Dark Oak, Winchester Oak, Night Oak	
6'10" x 6'2"	2080 x 1875	791	944	841	994	965	1118	1061	
6'6"	2080 x 2000	825	988	880	1043	1011	1174	1110	
6'10"	2080 x 2080	855	1024	914	1083	1049	1218	1153	
7'0" x 6'6"	2134 x 2000	854	1021	880	1047	1011	1178	1110	
7'0"	2134 x 2125	884	1061	914	1091	1049	1226	1153	
7'6" x 6'6"	2286 x 2000	854	1033	880	1059	1011	1190	1110	
7'0"	2286 x 2125	884	1074	914	1104	1049	1239	1153	
7'4"	2286 x 2250	896	1097	958	1159	1100	1301	1209	
7'9"	2286 x 2375	966	1178	998	1210	1147	1359	1262	
8'2"	2286 x 2500	964	1187	1037	1260	1193	1416	1312	
8'0" x 6'6"	2438 x 2000	897	1088	928	1119	1068	1259	1176	
7'0"	2438 x 2125	932	1135	968	1171	1115	1318	1227	
7'4"	2438 x 2250	939	1153	999	1213	1149	1363	1265	
7'9"	2438 x 2375	1011	1237	1044	1270	1202	1428	1324	
8'2"	2438 x 2500	1007	1245	1089	1327	1257	1495	1385	
8'6" x 6'6"	2591 x 2000	897	1100	928	1131	1068	1271	1176	
7'0"	2591 x 2125	932	1147	968	1183	1115	1330	1227	
9'0" x 6'6"	2740 x 2000	970	1184	1011	1225	1170	1384	1291	
7'0"	2740 x 2125	1004	1232	1052	1280	1217	1445	1342	
9'6" x 6'6"	2896 x 2000	1014	1240	1062	1288	1232	1458	1361	
7'0"	2896 x 2125	1054	1295	1106	1347	1281	1522	1416	
10'0" x 6'6"	3048 x 2000	980	1218	1062	1300	1232	1470	1361	
7'0"	3048 x 2125	1014	1267	1106	1359	1281	1534	1416	

For information on outside colour, see page 17

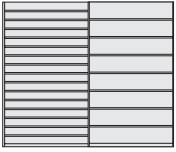
## Double doors with N track torsion springs (for low headroom see bottom of page 17)

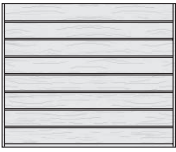
DOUBLE DOORS									
Door sizes BR		S-ribbed Woodgrain/ M-ribbed Woodgrain		M-ribbed Sandgrain		M-ribbed Silkgrain		M-ribbed Decograin	
Imperial	Metric	Outside White	Outside Colour	Outside White	Anthracite grey Terra brown White aluminium	Outside White	Outside Colour	Rosewood, Golden Oak, Dark Oak, Winchester Oak, Night Oak	
11'0" x 6'6"	3353 x 2000	1154	1416	1259	1521	1470	1732	1631	
7'0"	3353 x 2125	1199	1477	1309	1587	1528	1806	1695	
12'0" x 6'6"	3658 x 2000	1352	1638	1414	1700	1657	1943	1843	
7'0"	3658 x 2125	1405	1709	1471	1775	1723	2027	1916	
13'0" x 6'6"	3962 x 2000	1403	1713	1456	1766	1707	2017	1899	
7'0"	3962 x 2125	1456	1785	1510	1839	1772	2101	1972	
14'0" x 6'6"	4267 x 2000	1454	1787	1497	1830	1758	2091	1957	
7'0"	4267 x 2125	1512	1866	1557	1911	1829	2183	2036	
14'6" x 6'6"	4420 x 2000	1502	1847	1534	1879	1802	2147	2007	
7'0"	4420 x 2125	1561	1928	1597	1964	1876	2243	2089	
15'0" x 6'6"	4572 x 2000	1529	1886	1546	1903	1817	2174	2023	
7'0"	4572 x 2125	1589	1968	1610	1989	1893	2272	2109	
15'6" x 6'6"	4725 x 2000	1595	1964	1574	1943	1851	2220	2062	
7'0"	4725 x 2125	1658	2050	1637	2029	1925	2317	2145	
16'0" x 6'6"	4877 x 2000	1595	1976	1602	1983	1883	2264	2099	
7'0"	4877 x 2125	1658	2063	1664	2069	1958	2363	2182	



Intermediate sizes are available, please see your dealer for more details

# Hörmann Sectional Doors

LPU 40 – double-skinned doors with steel sections – 42mm

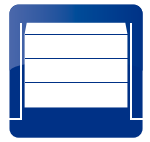

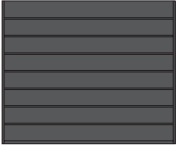
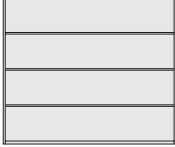
Single doors with Z track tension springs giving low headroom as standard

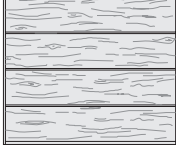

SINGLE DOORS						Door sizes BR		Rosewood, Golden Oak, Dark Oak, Winchester Oak, Night Oak		
Imperial	Metric					Outside White	Anthracite grey Terra brown White aluminium		Outside White	Outside Colour
6'10" x 6'2"	2080 x 1875					1061	995		1148	1103
6'6"	2080 x 2000	1110	1021	1184	1131	1294	1239			
6'10"	2080 x 2080	1153	1035	1204	1145	1314	1255			
7'0" x 6'6"	2134 x 2000	1110	1021	1188	1131	1298	1239			
7'0"	2134 x 2125	1153	1035	1212	1145	1322	1255			
7'6" x 6'6"	2286 x 2000	1110	1021	1200	1131	1310	1239			
7'0"	2286 x 2125	1153	1035	1225	1145	1335	1255			
7'4"	2286 x 2250	1209	1080	1281	1196	1397	1310			
7'9"	2286 x 2375	1262	1086	1298	1201	1413	1315			
8'2"	2286 x 2500	1312	1115	1338	1231	1454	1348			
8'0" x 6'6"	2438 x 2000	1176	1077	1268	1194	1385	1310			
7'0"	2438 x 2125	1227	1097	1300	1217	1420	1336			
7'4"	2438 x 2250	1265	1153	1367	1277	1491	1402			
7'9"	2438 x 2375	1324	1183	1409	1310	1536	1438			
8'2"	2438 x 2500	1385	1217	1455	1347	1585	1478			
8'6" x 6'6"	2591 x 2000	1176	1077	1280	1194	1397	1310			
7'0"	2591 x 2125	1227	1097	1312	1217	1432	1336			
9'0" x 6'6"	2740 x 2000	1291	1182	1396	1312	1526	1443			
7'0"	2740 x 2125	1342	1198	1426	1330	1558	1463			
9'6" x 6'6"	2896 x 2000	1361	1243	1469	1384	1610	1524			
7'0"	2896 x 2125	1416	1262	1503	1405	1646	1547			
10'0" x 6'6"	3048 x 2000	1361	1243	1481	1384	1622	1524			
7'0"	3048 x 2125	1416	1262	1515	1405	1658	1547			

For information on outside colour, see page 17

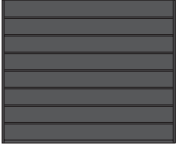
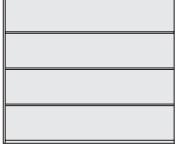
## Double doors with N track torsion springs (for low headroom see bottom of page 17)

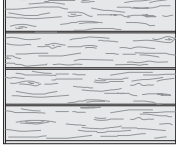
DOUBLE DOORS						Door sizes BR		Rosewood, Golden Oak, Dark Oak, Winchester Oak, Night Oak		
Imperial	Metric					Outside White	Anthracite grey Terra brown White aluminium		Outside White	Outside Colour
11'0" x 6'6"	3353 x 2000					1631	1470		1732	1643
7'0"	3353 x 2125	1695	1493	1771	1669	1947	1843			
12'0" x 6'6"	3658 x 2000	1843	1656	1942	1856	2142	2055			
7'0"	3658 x 2125	1916	1686	1990	1890	2194	2092			
13'0" x 6'6"	3962 x 2000	1899	1707	2017	1916	2226	2123			
7'0"	3962 x 2125	1972	1732	2061	1942	2271	2151			
14'0" x 6'6"	4267 x 2000	1957	1758	2091	1973	2306	2187			
7'0"	4267 x 2125	2036	1787	2141	2005	2359	2222			
14'6" x 6'6"	4420 x 2000	2007	1806	2151	2028	2373	2248			
7'0"	4420 x 2125	2089	1836	2203	2060	2427	2284			
15'0" x 6'6"	4572 x 2000	2023	1825	2182	2049	2406	2272			
7'0"	4572 x 2125	2109	1854	2233	2083	2462	2310			
15'6" x 6'6"	4725 x 2000	2062	1858	2227	2088	2457	2316			
7'0"	4725 x 2125	2145	1891	2283	2123	2515	2354			
16'0" x 6'6"	4877 x 2000	2099	1890	2271	2124	2505	2357			
7'0"	4877 x 2125	2182	1923	2328	2162	2567	2399			

Intermediate sizes are available, please see your dealer for more details

# Hörmann Sectional Doors

## LPU 40 – double-skinned doors with steel sections – 42mm

Single doors with Z track tension springs giving low headroom as standard

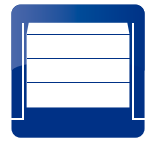

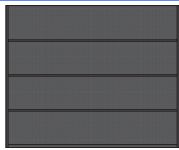
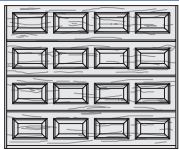
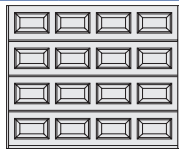
SINGLE DOORS		 L-ribbed Titan Metallic CH 703	 S-panelled Decograin	 S-panelled Woodgrain					
Door sizes BR					Rosewood, Golden Oak, Dark Oak, Winchester Oak, Night Oak	No. of panels	Outside White	Outside Colour	No. of panels
Imperial	Metric								
6'10" x 6'2"	2080 x 1875	1210	1297	4	992	1145	4		
	6'6"	2080 x 2000	1239	1323	4	1039	1202	4	
	6'10"	2080 x 2080	1255			1052	1221	4	
7'0" x 6'6"	2134 x 2000	1239	1323	4	1075	1242	4		
	7'0"	2134 x 2125	1255	1338	4	1088	1265	4	
7'6" x 6'6"	2286 x 2000	1239	1323	4	1075	1254	4		
	7'0"	2286 x 2125	1255	1338	4	1088	1278	4	
	7'4"	2286 x 2250	1310	1461	4	1087	1288	4	
	7'9"	2286 x 2375	1315	1494	4	1161	1373	4	
8'2" x 6'6"	2286 x 2500	1348	1547	4	1159	1382	4		
	8'0" x 6'6"	2438 x 2000	1310	1404	4	1134	1325	4	
	7'0"	2438 x 2125	1336	1423	4	1150	1353	4	
	7'4"	2438 x 2250	1402	1606	4	1146	1360	4	
8'6" x 6'6"	7'9"	2438 x 2375	1438	1629	4	1219	1445	4	
	8'2"	2438 x 2500	1478	1659	4	1218	1456	4	
	8'6" x 6'6"	2591 x 2000	1310	1404	4	1134	1337	4	
	7'0"	2591 x 2125	1336	1423	4	1150	1365	4	
9'0" x 6'6"	2740 x 2000	1443	1539	4	1231	1445	4		
	7'0"	2740 x 2125	1463	1566	4	1250	1478	4	
9'6" x 6'6"	2896 x 2000	1524	1624	5	1292	1518	5		
	7'0"	2896 x 2125	1547	1652	5	1318	1559	5	
10'0" x 6'6"	3048 x 2000	1524	1624	5	1241	1479	5		
	7'0"	3048 x 2125	1547	1652	5	1267	1520	5	

For information on outside colour, see below

All coloured doors are special order only – 4 to 8 weeks delivery. Please note: the prices listed as Outside Colour are for the following RAL colours only: RAL 1015, 3003, 5011, 5014, 6005, 6009, 7016, 7030, 7035, 7040, 8001, 8003, 8028, 9006 and 9007. Special RAL colours are available, please ask your garage door specialist.

**Double doors with N track torsion springs (for low headroom see bottom of page)**

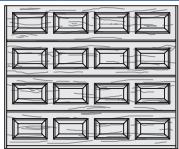
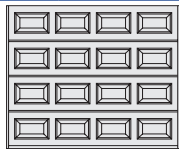
DOUBLE DOORS		 L-ribbed Titan Metallic CH 703	 S-panelled Decograin	 S-panelled Woodgrain					
Door sizes BR					Rosewood, Golden Oak, Dark Oak, Winchester Oak, Night Oak	No. of panels	Outside White	Outside Colour	No. of panels
Imperial	Metric								
11'0" x 6'6"	3353 x 2000	1816	1930	5	1480	1742	5		
	7'0"	3353 x 2125	1843	1963	5	1507	1785	5	
12'0" x 6'6"	3658 x 2000	2055	2182	6	1744	2030	6		
	7'0"	3658 x 2125	2092	2219	6	1773	2077	6	
13'0" x 6'6"	3962 x 2000	2123	2253	6	1813	2123	6		
	7'0"	3962 x 2125	2151	2285	6	1838	2167	6	
14'0" x 6'6"	4267 x 2000	2187	2322	7	1885	2218	7		
	7'0"	4267 x 2125	2222	2359	7	1915	2269	7	
14'6" x 6'6"	4420 x 2000	2248	2385	7	1952	2297	7		
	7'0"	4420 x 2125	2284	2423	7	1985	2352	7	
15'0" x 6'6"	4572 x 2000	2272	2413	7	1988	2345	7		
	7'0"	4572 x 2125	2310	2450	7	2021	2400	7	
15'6" x 6'6"	4725 x 2000	2316	2459	7	2085	2454	7		
	7'0"	4725 x 2125	2354	2497	7	2118	2510	7	
16'0" x 6'6"	4877 x 2000	2357	2505	7	2085	2466	7		
	7'0"	4877 x 2125	2399	2545	7	2118	2523	7	

### Low headroom

Door with track application L, torsion spring at the back

### Price

111

Intermediate sizes are available, please see your dealer for more details

# Hörmann Sectional Doors



## Optional extras for sectional doors

Colour surcharge	Price
RAL to choose colours (please ask to see colour chart)	per m <sup>2</sup> <b>54</b>
Door leaf in special colours (please ask to see colour chart)	per m <sup>2</sup> <b>108</b>

Fittings	Article no.	Price
 Profile half cylinder 30 + 10 mm, keys to pass, for garage door handle sets	3091459	Each <b>27</b>

The below listed handle sets are supplied with:

- Lock with profile half cylinder with side locking
- Template for lock knock-out on site

A factory lock knock-out will result in a longer delivery time and must be ordered explicitly (State position on order!)

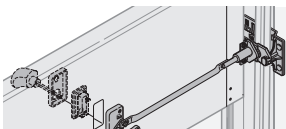
 Door handle set, black plastic, prepared for profile cylinder	3060828	Each <b>49</b>
Door handle set, silver finish cast aluminium (F2), prepared for profile cylinder	3060829	Each <b>123</b>
Door handle set, cast aluminium RAL 9016, prepared for profile cylinder	3060831	Each <b>139</b>
Door handle set, brown cast aluminium, prepared for profile cylinder	3076054	Each <b>139</b>
Door handle set, brushed stainless steel, prepared for profile cylinder	3060835	Each <b>139</b>

Emergency release	Price
Emergency release for sectional doors <b>with</b> or <b>without</b> handle set (Please state at point of order)	Each <b>39</b>

Special anchor set	Price
Set of 8 special anchors for between wall fitting	per set <b>43</b>

ThermoFrame – Frame support with thermal break	Price
ThermoFrame set	£

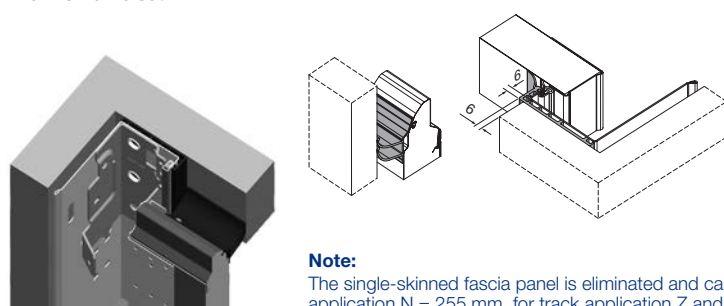

### Set consists of:

- **Lintel seal (1 unit)**  
With 2 lip seals
- **Plastic angle profiles (2 units)**  
Black, 84 × 22.5 mm with lip seal (frame covering may be needed to match the colour)

### Note:

The single-skinned fascia panel is eliminated and cannot be fitted. Headroom required for track application N = 255 mm, for track application Z and L = 145 mm.

Please also note the supplements and limitations in the technical manual!

<b>ThermoFrame set 1</b> Article no. 4004702	RM height ≤ 3000 mm LZ width ≤ 3250 mm	Plastic angle profiles Length 3210 mm Lintel seal Length 3250 mm	Each <b>217</b>
<b>ThermoFrame set 2</b> Article no. 4006087	RM height ≤ 3000 mm LZ width > 3250 mm and ≤ 6000 mm	Plastic angle profiles Length 3210 mm Lintel seal Length 6000 mm	Each <b>257</b>
<b>ThermoFrame set 3</b> Article no. 4004982	For doors with track application H	Plastic angle profiles Length 4500 mm Lintel seal Length 5500 mm	Each <b>257</b>

### Frame cover profiles matching the colour of the door – 55mm × 19.5mm and 90mm × 19.5mm: prices are per pair

Door heights	White RAL 9016						Colour						RAL to choose/CH 703				Decograin/Titan Metallic CH 703	
	Woodgrain		Sandgrain		Silkgrain		Woodgrain		Sandgrain		Silkgrain		Woodgrain		Silkgrain		55mm	90mm
	55mm	90mm	55mm	90mm	55mm	90mm	55mm	90mm	55mm	90mm	55mm	90mm	55mm	90mm				
1875mm	47	60	51	66	51	66	59	83	62	87	62	87	77	117	83	124	70	94
2000mm	50	64	54	70	54	70	62	88	66	92	66	92	82	124	88	132	74	100
2080mm	52	67	57	73	57	73	65	92	69	96	69	96	86	129	92	138	77	104
2125mm	54	68	58	75	58	75	66	94	71	98	71	98	88	132	94	141	79	107
2250mm	57	72	61	79	61	79	70	99	75	104	75	104	93	140	99	149	84	113
2375mm	60	76	65	84	65	84	74	105	79	110	79	110	98	148	105	157	88	119
2500mm	63	80	68	88	68	88	78	110	83	115	83	115	103	155	110	165	93	125

Silkgrain white/Titan Metallic CH 703 and Decograin colours are available ex-stock. **Please note colours and RAL to choose/CH 703 must be ordered with the door.**

Sandgrain is available in RAL 9016, 7016, 8028 and 9006

Door heights	White RAL 9016						Colour						RAL to choose/CH 703				Decograin/Titan Metallic CH 703	
	Woodgrain		Sandgrain		Silkgrain		Woodgrain		Sandgrain		Silkgrain		Woodgrain		Silkgrain		55mm	90mm
	55mm	90mm	55mm	90mm	55mm	90mm	55mm	90mm	55mm	90mm	55mm	90mm	55mm	90mm				
Set: Renovation fascias to cover damaged brickwork edges consisting of: 3 angle sections, 69/40mm, each 3000mm long	<b>135</b>	<b>147</b>	<b>147</b>	<b>174</b>	<b>186</b>	<b>186</b>	<b>189</b>	<b>201</b>	<b>154</b>									

Set: Fascia frame -95- consisting of: 2 fascias, 95mm, 2800mm long, 1 fascia 95mm, 3200mm long, fixing material	<b>157</b>	<b>166</b>	<b>166</b>	<b>196</b>	<b>205</b>	<b>205</b>	<b>211</b>	<b>220</b>	<b>172</b>
---	------------	------------	------------	------------	------------	------------	------------	------------	------------





# Hörmann Sectional Doors









## Glazing options for sectional doors

LTE 40 with 3mm single pane in clear (FK) or crystal structure (KR), 3mm

LPU 40 with 16mm (for panelled) or 22mm (for ribbed) double pane in clear (DS) or crystal structure (DK)

Glazings		£/each
S0		With synthetic single pane, 3 mm, clear or crystal structure LTE 40 <b>75</b>
		With synthetic double pane, 16 mm, clear / clear or crystal structure / crystal structure LPU 40 <b>81</b>
S1		With synthetic single pane, 3 mm, clear or crystal structure LTE 40 <b>90</b>
		With synthetic double pane, 16 mm, clear / clear or crystal structure / crystal structure LPU 40 <b>99</b>
S2		With synthetic single pane, 3 mm, clear or crystal structure LTE 40 <b>90</b>
		With synthetic double pane, 16 mm, clear / clear or crystal structure / crystal structure LPU 40 <b>99</b>
S 10 – S 60		With synthetic single pane, 3 mm, clear or crystal structure LTE 40 <b>95</b>
		With synthetic double pane, 16 mm, clear / clear or crystal structure / crystal structure LPU 40 <b>102</b>

### Sunrise glazing variants for S-panelled version

		£/section
S 10		<ul style="list-style-type: none"> <li>With synthetic single pane, 3 mm</li> <li>Clear or crystal structure</li> </ul> For LTE 40 (4 × £95) <b>380</b>
	LTE 40 Door width 2075 mm up to 2740 mm LPU 40 Door width 2130 mm up to 2750 mm	<ul style="list-style-type: none"> <li>With synthetic double pane, 16 mm</li> <li>Clear / clear or crystal structure / crystal structure</li> </ul> For LPU 40 (4 × £102) <b>408</b>
S 20		<ul style="list-style-type: none"> <li>With synthetic single pane, 3 mm</li> <li>Clear or crystal structure</li> </ul> For LTE 40 (5 × £95) <b>475</b>
	LTE 40 Door width 2745 mm up to 3000 mm LPU 40 Door width 2755 mm up to 3500 mm	<ul style="list-style-type: none"> <li>With synthetic double pane, 16 mm</li> <li>Clear / clear or crystal structure / crystal structure</li> </ul> For LPU 40 (5 × £102) <b>510</b>
S 30		<ul style="list-style-type: none"> <li>With synthetic double pane, 16 mm</li> <li>Clear / clear or crystal structure / crystal structure</li> </ul> For LPU 40 (6 × £102) <b>612</b>
	LPU 40 Door width 3505 mm up to 4000 mm	
S 40		<ul style="list-style-type: none"> <li>With synthetic double pane, 16 mm</li> <li>Clear / clear or crystal structure / crystal structure</li> </ul> For LPU 40 (7 × £102) <b>714</b>
	LPU 40 Door width 4005 mm up to 4750 mm	
S 50		<ul style="list-style-type: none"> <li>With synthetic double pane, 16 mm</li> <li>Clear / clear or crystal structure / crystal structure</li> </ul> For LPU 40 (8 × £102) <b>816</b>
	LPU 40 Door width 4755 mm up to 5500 mm	
S 60		<ul style="list-style-type: none"> <li>With synthetic double pane, 16 mm</li> <li>Clear / clear or crystal structure / crystal structure</li> </ul> For LPU 40 (8 × £102) <b>816</b>
	LPU 40 Door width 4755 mm up to 5500 mm	

### Standard Colour Surcharges for the above windows. Please note: front window frame only is painted

		Price
Standard colour or colour for Decograin	For glazing S0, S1 and S2	Each <b>24</b>
	For Sunrise glazing × No. of frames for width of door	Each <b>30</b>
RAL to choose	For glazing S0, S1 and S2	Each <b>40</b>
	For Sunrise glazing × No. of frames for width of door	Each <b>53</b>



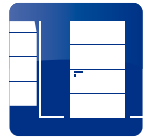

# Aluminium Garage Side Doors

Double-leaf side doors with block frame made of aluminium profiles; door infill made of steel sectional door sections



## Size range, ribbed, profile type 2

For an overview of dimensions and optional extras, please see your dealer for more details.

Size range										
	Exterior White	Exterior Colour	Exterior White	Exterior Colour	Exterior White	Exterior Colour	Exterior White	Exterior Colour	Exterior White	Exterior Colour
Ordering sizes Overall frame dimensions (RAM)	<b>S-ribbed Woodgrain</b>		<b>M-ribbed Woodgrain</b>		<b>M-ribbed Sandgrain 1)</b>		<b>M-ribbed Silkgrain</b>		<b>M-ribbed Decograin 2)</b>	
Width x Height									Exterior <b>Timber design / Titan Metallic CH 703</b>	
<b>Fitting in the opening – opening outwards</b>										
From 1200 x 1960										
Up to 1600 x 2100	<b>1980</b>	<b>2241</b>	<b>1980</b>	<b>2241</b>	<b>2055</b>	<b>2316</b>	<b>2119</b>	<b>2380</b>	<b>2316</b>	
Up to 1600 x 2250	<b>1987</b>	<b>2248</b>	<b>1987</b>	<b>2248</b>	<b>2063</b>	<b>2323</b>	<b>2126</b>	<b>2387</b>	<b>2323</b>	
Up to 1600 x 2558	<b>1994</b>	<b>2255</b>	<b>1994</b>	<b>2255</b>	<b>2070</b>	<b>2331</b>	<b>2135</b>	<b>2396</b>	<b>2332</b>	
Up to 1800 x 2100	<b>2002</b>	<b>2262</b>	<b>2002</b>	<b>2262</b>	<b>2077</b>	<b>2338</b>	<b>2142</b>	<b>2403</b>	<b>2341</b>	
Up to 1800 x 2250	<b>2008</b>	<b>2269</b>	<b>2008</b>	<b>2269</b>	<b>2085</b>	<b>2346</b>	<b>2150</b>	<b>2410</b>	<b>2348</b>	
Up to 1800 x 2558	<b>2015</b>	<b>2276</b>	<b>2015</b>	<b>2276</b>	<b>2092</b>	<b>2353</b>	<b>2157</b>	<b>2418</b>	<b>2358</b>	
Up to 2000 x 2100	<b>2023</b>	<b>2284</b>	<b>2023</b>	<b>2284</b>	<b>2099</b>	<b>2359</b>	<b>2164</b>	<b>2425</b>	<b>2365</b>	
Up to 2000 x 2250	<b>2029</b>	<b>2290</b>	<b>2029</b>	<b>2290</b>	<b>2106</b>	<b>2367</b>	<b>2172</b>	<b>2432</b>	<b>2373</b>	
Up to 2000 x 2558	<b>2037</b>	<b>2297</b>	<b>2037</b>	<b>2297</b>	<b>2113</b>	<b>2374</b>	<b>2181</b>	<b>2442</b>	<b>2382</b>	
Up to 2200 x 2100	<b>2043</b>	<b>2304</b>	<b>2043</b>	<b>2304</b>	<b>2121</b>	<b>2382</b>	<b>2188</b>	<b>2449</b>	<b>2389</b>	
Up to 2200 x 2250	<b>2051</b>	<b>2311</b>	<b>2051</b>	<b>2311</b>	<b>2129</b>	<b>2390</b>	<b>2196</b>	<b>2457</b>	<b>2398</b>	
Up to 2200 x 2558	<b>2058</b>	<b>2319</b>	<b>2058</b>	<b>2319</b>	<b>2137</b>	<b>2397</b>	<b>2203</b>	<b>2464</b>	<b>2407</b>	
Up to 2500 x 2100	<b>2064</b>	<b>2325</b>	<b>2064</b>	<b>2325</b>	<b>2143</b>	<b>2404</b>	<b>2211</b>	<b>2471</b>	<b>2415</b>	
Up to 2500 x 2250	<b>2072</b>	<b>2333</b>	<b>2072</b>	<b>2333</b>	<b>2150</b>	<b>2411</b>	<b>2218</b>	<b>2479</b>	<b>2423</b>	
Up to 2500 x 2558	<b>2079</b>	<b>2340</b>	<b>2079</b>	<b>2340</b>	<b>2158</b>	<b>2419</b>	<b>2224</b>	<b>2484</b>	<b>2432</b>	

- 1) Surface in **Sandgrain** only available in the colours RAL 7016 Anthracite grey, RAL 8028 Terra brown and RAL 9006 White aluminium. Other colours or RAL to choose are not possible!
- 2) **Decograin** surface with timber design film coating or decor film coating in Titan Metallic CH 703. Please state desired decor on order!

<b>Fastening holes</b>	<b>£</b>
Fastening holes for fitting in the opening	Per door <b>14</b>
<b>RAL to choose</b> (based on the RAL CLASSIC colour chart) <b>or colour CH 703</b>	<b>£</b>
Frame inside and outside, infill outside	Surcharge on white version per door <b>400</b>
<b>Glazings</b> (not possible for the two bottom door sections or with 3-point locking)	
Glazing type D / section as aluminium frame	See page 304 in Price List (EN) 01-16 A
Glazing with panel glazing type S or type M	See from page 306 in Price List (EN) 01-16 A
<b>Fittings and further optional extras</b>	See from page 300 in Price List (EN) 01-16 A





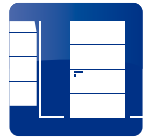

# Aluminium Garage Side Doors

Double-leaf side doors with block frame made of aluminium profiles; door infill made of steel sectional door sections



## Size range, ribbed, profile type 2

For an overview of dimensions and optional extras, please see your dealer for more details.

Size range										
	L-ribbed <i>Woodgrain</i>		L-ribbed <i>Sandgrain</i> <sup>1)</sup>		L-ribbed <i>Silkgrain</i>		L-ribbed <i>Micrograin</i>		L-ribbed <i>Decograins</i> <sup>2)</sup>	
Ordering sizes Overall frame dimensions (RAM)	Exterior White	Exterior Colour	Exterior White	Exterior Colour	Exterior White	Exterior Colour	Exterior White	Exterior Colour	Exterior Timber design / Titan Metallic CH 703	
Width x Height										
<b>Fitting in the opening – opening outwards</b>										
From 1200 x 1960										
Up to 1600 x 2100	<b>2047</b>	<b>2308</b>	<b>2125</b>	<b>2386</b>	<b>2191</b>	<b>2452</b>	<b>2191</b>	<b>2452</b>	<b>2395</b>	
Up to 1600 x 2250	<b>2054</b>	<b>2315</b>	<b>2134</b>	<b>2395</b>	<b>2199</b>	<b>2459</b>	<b>2199</b>	<b>2459</b>	<b>2403</b>	
Up to 1600 x 2558	<b>2062</b>	<b>2322</b>	<b>2141</b>	<b>2402</b>	<b>2206</b>	<b>2467</b>	<b>2206</b>	<b>2467</b>	<b>2412</b>	
Up to 1800 x 2100	<b>2069</b>	<b>2330</b>	<b>2149</b>	<b>2409</b>	<b>2213</b>	<b>2474</b>	<b>2213</b>	<b>2474</b>	<b>2420</b>	
Up to 1800 x 2250	<b>2077</b>	<b>2338</b>	<b>2156</b>	<b>2417</b>	<b>2221</b>	<b>2482</b>	<b>2221</b>	<b>2482</b>	<b>2429</b>	
Up to 1800 x 2558	<b>2084</b>	<b>2345</b>	<b>2163</b>	<b>2424</b>	<b>2228</b>	<b>2489</b>	<b>2228</b>	<b>2489</b>	<b>2437</b>	
Up to 2000 x 2100	<b>2091</b>	<b>2352</b>	<b>2171</b>	<b>2432</b>	<b>2237</b>	<b>2498</b>	<b>2237</b>	<b>2498</b>	<b>2446</b>	
Up to 2000 x 2250	<b>2098</b>	<b>2359</b>	<b>2179</b>	<b>2440</b>	<b>2245</b>	<b>2506</b>	<b>2245</b>	<b>2506</b>	<b>2455</b>	
Up to 2000 x 2558	<b>2105</b>	<b>2366</b>	<b>2187</b>	<b>2448</b>	<b>2252</b>	<b>2513</b>	<b>2252</b>	<b>2513</b>	<b>2463</b>	
Up to 2200 x 2100	<b>2113</b>	<b>2373</b>	<b>2195</b>	<b>2456</b>	<b>2260</b>	<b>2520</b>	<b>2260</b>	<b>2520</b>	<b>2472</b>	
Up to 2200 x 2250	<b>2120</b>	<b>2381</b>	<b>2202</b>	<b>2463</b>	<b>2267</b>	<b>2528</b>	<b>2267</b>	<b>2528</b>	<b>2481</b>	
Up to 2200 x 2558	<b>2128</b>	<b>2389</b>	<b>2210</b>	<b>2470</b>	<b>2274</b>	<b>2535</b>	<b>2274</b>	<b>2535</b>	<b>2489</b>	
Up to 2500 x 2100	<b>2136</b>	<b>2396</b>	<b>2217</b>	<b>2478</b>	<b>2282</b>	<b>2543</b>	<b>2282</b>	<b>2543</b>	<b>2497</b>	
Up to 2500 x 2250	<b>2142</b>	<b>2403</b>	<b>2224</b>	<b>2485</b>	<b>2290</b>	<b>2551</b>	<b>2290</b>	<b>2551</b>	<b>2506</b>	
Up to 2500 x 2558	<b>2150</b>	<b>2410</b>	<b>2230</b>	<b>2491</b>	<b>2300</b>	<b>2561</b>	<b>2300</b>	<b>2561</b>	<b>2514</b>	

- 1) Surface in *Sandgrain* only available in the colours RAL 7016 Anthracite grey, RAL 8028 Terra brown and RAL 9006 White aluminium. Other colours or RAL to choose are not possible!  
 2) *Decograins* surface with timber design film coating or decor film coating in Titan Metallic CH 703. Please state desired decor on order!

<b>Fastening holes</b>	<b>£</b>
Fastening holes for fitting in the opening	Per door <b>14</b>
<b>RAL to choose</b> (based on the RAL CLASSIC colour chart) <b>or colour CH 703</b>	<b>£</b>
Frame inside and outside, infill outside	Surcharge on white version per door <b>400</b>
<b>Glazings</b> (not possible for the two bottom door sections or with 3-point locking)	
Glazing type D / section as aluminium frame	See page 304 in Price List (EN) 01-16 A
Glazing with panel glazing type S or type M	See from page 306 in Price List (EN) 01-16 A
<b>Design elements for L-ribbed doors in <i>Silkgrain</i>, <i>Sandgrain</i>, <i>Woodgrain</i> and <i>Micrograin</i></b> (number of elements based on technical feasibility)	See page 224 in Price List (EN) 01-16 A
<b>Fittings and further optional extras</b>	See from page 300 in Price List (EN) 01-16 A

# RollMatic Roller Garage Door

Including operator

## Size range and prices



Doors are only available in the priced size range listed! (Min. Production dimension 1000 x 1600mm) Note: Door size not over guide width



Exterior  
**White or Colour**

(same price)

### Prices for internal roller garage doors

Clear height (LH) = ordering size	3100					1597	1736	1782	1839	1884	2166	2244	2339	2386					
	3000					1597	1736	1782	1839	1884	2166	2244	2339	2386					
	2875					1597	1736	1782	1839	1884	2166	2244	2339	2386					
	2750					1597	1736	1782	1839	1884	2166	2244	2339	2386					
	2675					1575	1663	1718	1783	1851	2103	2193	2273	2352					
	2625	1448	1448	1502	1502	1575	1663	1718	1783	1851	2103	2193	2273	2352					
	2500	1448	1448	1502	1502	1575	1663	1718	1783	1851	2103	2193	2273	2352					
	2375	1448	1448	1502	1502	1523	1614	1669	1732	1782	1898	2110	2152	2239	2333	2385	2437	2486	
	2250	1355	1355	1382	1382	1472	1587	1627	1662	1725	1835	2031	2112	2133	2254	2304	2356	2407	
	2125	1355	1355	1382	1382	1472	1587	1627	1662	1725	1835	2031	2112	2133	2254	2304	2356	2407	
	2000	1355	1355	1382	1382	1447	1539	1566	1610	1655	1744	1803	2042	2062	2191	2242	2294	2345	
	1800	1355	1355	1382	1382	1395	1473	1525	1577	1600	1682	1736	1957	2006	2098	2147	2199	2251	
	1600	1355	1355	1382	1382	1395	1473	1525	1577	1600	1682	1736	1957	2006	2098	2147	2199	2251	
		1000	1250	1500	1750	1900	2000	2250	2500	2750	3000	3250	3500	3750	4000	4250	4500	4750	5000
		Clear width (LB) = ordering size																	

Manually operated version of the RollMatic roller garage door (not possible with external roller garage doors)

Price reduction **-162**

External roller garage door

Surcharge **62**

**Additional fascia panel**

(Reinforcement of the fascia panel for fitting in the opening required)

See page 25

# RollMatic Roller Garage Door

Including operator

## Size range and prices



Doors are only available in the priced size range listed! (Min. Production dimension 1000 x 1600mm) Note: Door size not over guide width



Exterior  
**Decopaint\***

\* Painted in timber design look on inside and outside

Golden Oak or Rosewood

### Prices for internal roller garage doors

Clear height (LH) = ordering size	3100					1721	1875	1936	2009	2069	2366	2459	2570	2632					
	3000					1716	1870	1931	2003	2063	2360	2452	2562	2624					
	2875					1711	1865	1925	1996	2056	2351	2444	2553	2613					
	2750					1684	1786	1854	1933	2015	2280	2384	2478	2570					
	2675	1514	1529	1595	1604	1682	1783	1850	1929	2011	2275	2379	2472	2564					
	2625	1514	1527	1594	1601	1679	1781	1848	1926	2008	2272	2375	2468	2560					
	2500	1511	1523	1589	1597	1622	1727	1793	1869	1931	2060	2284	2338	2437	2544	2608	2672	2733	
	2375	1415	1426	1465	1472	1567	1693	1745	1792	1867	1988	2197	2289	2321	2454	2515	2580	2642	
	2250	1412	1422	1460	1467	1562	1688	1739	1785	1859	1981	2188	2279	2312	2444	2505	2568	2630	
	2125	1409	1418	1456	1463	1532	1635	1673	1726	1782	1881	1952	2201	2230	2370	2432	2494	2556	
	2000	1405	1415	1451	1457	1475	1563	1624	1686	1719	1811	1875	2106	2164	2266	2325	2387	2449	
	1800	1400	1409	1445	1450	1467	1554	1614	1676	1707	1798	1861	2091	2149	2250	2308	2369	2430	
	1600																		
		1000	1250	1500	1750	1900	2000	2250	2500	2750	3000	3250	3500	3750	4000	4250	4500	4750	5000
		Clear width (LB) = ordering size																	

Manually operated version of the RollMatic roller garage door (not possible with external roller garage doors) Price reduction **-162**

External roller garage door Surcharge **62**

**Additional fascia panel**  
(Reinforcement of the fascia panel for fitting in the opening required) See page 25

# RollMatic Roller Garage Door

Including operator

## Size range and prices



Doors are only available in the priced size range listed! (Min. Production dimension 1000 x 1600mm) Note: Door size not over guide width



Exterior  
**Decograin \***

**Note:**  
External roller garage door not available with a Decograin surface!

\* Plastic film coating in timber design look on outside

Golden Oak or Rosewood

### Prices for internal roller garage doors

Clear height (LH) = ordering size	3100					2074	2268	2358	2461	2550	2898	3024	3168	3260					
	3000					2064	2256	2346	2446	2534	2883	3006	3149	3240					
	2875					2052	2242	2331	2429	2515	2862	2983	3125	3214					
	2750					2015	2148	2243	2350	2460	2772	2907	3029	3151					
	2675	1766	1799	1892	1914	2008	2139	2232	2340	2447	2760	2893	3016	3136					
	2625	1762	1796	1888	1909	2003	2133	2227	2333	2440	2751	2885	3006	3126					
	2500	1754	1786	1878	1897	1931	2065	2157	2258	2346	2505	2770	2848	2975	3111	3200	3290	3376	
	2375	1644	1674	1733	1751	1864	2020	2095	2165	2263	2415	2661	2780	2834	2997	3083	3171	3257	
	2250	1636	1665	1723	1739	1851	2006	2079	2147	2245	2394	2638	2756	2808	2970	3053	3141	3224	
	2125	1628	1655	1710	1727	1811	1939	1996	2071	2149	2273	2365	2655	2704	2873	2957	3040	3124	
	2000	1620	1645	1699	1715	1740	1852	1933	2017	2068	2183	2268	2537	2616	2743	2823	2906	2988	
	1800	1606	1630	1682	1695	1719	1829	1909	1990	2037	2150	2233	2499	2575	2699	2777	2858	2937	
	1600																		
		1000	1250	1500	1750	1900	2000	2250	2500	2750	3000	3250	3500	3750	4000	4250	4500	4750	5000
		Clear width (LB) = ordering size																	

Manually operated version of the RollMatic roller garage door (not possible with external roller garage doors)

Price reduction **-162**

**Additional fascia panel**  
(Reinforcement of the fascia panel for fitting in the opening required)

See page 25

# Optional Extras

## For RollMatic roller garage door including operator



Fitting compensation set (to accommodate for unevenness on the building structure when fitting behind/in front of the opening)	Article no.	£
Fitting compensation set LH ≤ 2300	8991235 Per set	<b>33</b>
Fitting compensation set LH > 2300	8991236 Per set	<b>38</b>

Chamfered bottom profile	£
RollMatic roller garage door with chamfered bottom profile (not available in the surfaces Golden Oak and Rosewood)	In black Per m <b>188</b> In door colour Per m <b>188</b>



Symmetrical barrel casing	£
Symmetrical barrel casing for a visually balanced look	Per door <b>No surcharge</b>

Additional fascia panel	£
Reinforcement of the fascia panel	
<b>Note:</b> Required for fitting in the opening!	In door colour Per m <b>46</b>

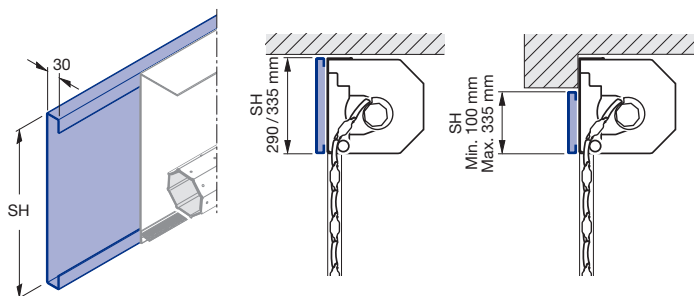
► State height (SH) and width!

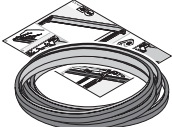

**Note:**  
State on door order, subsequent fitting is not possible.

Optional extras	Article no.	£
 <b>Glazing element</b> With clear synthetic pane, window cut-out 112 × 33 mm, black glazing frame on exterior, transparent on interior (maximum 10 sections per door, number of glazing elements depending on the door width)	Per m	<b>22</b>
 <b>Ventilation grilles</b> Black plastic Ventilation cross section: approx. 13 cm <sup>2</sup> /grille (maximum of 10 sections per door, number of ventilation grilles dependent on the door width)	Per m	<b>22</b>
 <b>Brush seal for fascia panel</b>	LB up to 3000 mm Per door <b>12</b> LB from 3000 mm to 5000 mm Per door <b>17</b>	

<b>2-coloured</b> roller garage door (after technical inspection)	Per door	<b>90</b>
<b>Aluminium cover for side guides</b> (as standard with external roller garage door)	Per m	<b>36</b>

Accessories for RollMatic operator	Article no.	£
Motor connection line, 10 m	436523	<b>30</b>
Acoustic anti-lift kit	436524 Each	<b>49</b>
Emergency battery HNA 18-3	437726 Each	<b>141</b>
Emergency release	£	
Exterior emergency release for internal roller garage door	436526 Each	<b>79</b>
Exterior emergency release for external roller garage door	Exterior emergency release 436526 Each <b>79</b> Accessory bag for double secured release SE 437728 Each <b>6</b>	
<b>Note:</b> All 3 articles are required for the external roller garage door!	Bowden cable, length 1 m, for double secured release SE 437986 Each	<b>10</b>

**Further accessories for RollMatic operator** See from page 335 in Price List (EN) 01-16-A

# Optional Extras

## For RollMatic roller garage door including operator



### Matching side door and accessories



Style 996

Ordering sizes Ordering dimensions	Style 996	Style 996	Style 996
Width x height	White or Colour	<i>Decopaint</i> Golden Oak or Rosewood	<i>Decograin</i> Golden Oak or Rosewood
<b>Size range</b>			
From 675 x 1750			
Up to 1000 x 2000	<b>724</b>	<b>767</b>	<b>923</b>
Up to 1250 x 2375	<b>775</b>	<b>839</b>	<b>1014</b>

### Lever handle sets for side doors

Article no. £

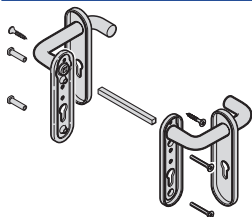

Standard: black plastic, prepared for profile cylinder	1324002	Each	<b>43</b>
Cast aluminium with silver finish (F2), prepared for profile cylinder	1386100	Each	<b>145</b>
Cast aluminium in RAL 9016 (White), prepared for profile cylinder	1386150	Each	<b>180</b>
Cast aluminium in RAL 8028 (Brown), prepared for profile cylinder	1386330	Each	<b>180</b>
Brushed stainless steel, prepared for profile cylinder	1386351	Each	<b>217</b>
Polished stainless steel, prepared for profile cylinder	1386350	Each	<b>217</b>

### Lever / knob handle sets for side doors

Article no. £

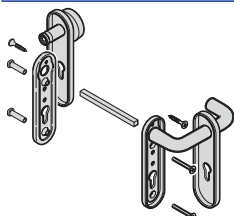

Standard: black plastic, prepared for profile cylinder	1380000	Each	<b>88</b>
Cast aluminium with silver finish (F2), prepared for profile cylinder	1380100	Each	<b>177</b>
Cast aluminium in RAL 9016 (White), prepared for profile cylinder	1380150	Each	<b>213</b>
Cast aluminium in RAL 8028 (Brown), prepared for profile cylinder	1380330	Each	<b>213</b>
Brushed stainless steel, prepared for profile cylinder	1380351	Each	<b>264</b>
Polished stainless steel, prepared for profile cylinder	1380350	Each	<b>264</b>

### Profile cylinders with 2 keys for side doors

Article no. £

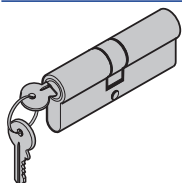

<b>40.5 + 31.5 mm</b>	1320003	Each	<b>53</b>
For RollMatic side doors			

### Rain canopy

£

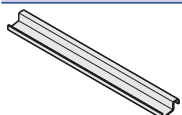

<b>Rain canopy for single-leaf garage doors</b>			
White or brown		Each	<b>47</b>
Colour		Each	<b>56</b>
RAL to choose		Each	<b>63</b>

### Door stay

Article no. £

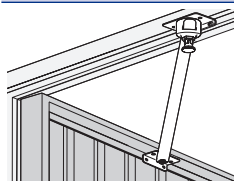

<b>Door stay retrofit kit</b>	1388000	Each	<b>50</b>
-------------------------------	---------	------	-----------



# Roller Garage Door – RollMatic TDL

Including tubular drive

## Size range and prices



### Prices for internal roller garage doors

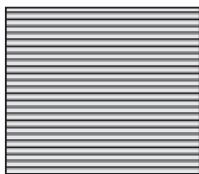

Exterior  
RAL 9016 Traffic white or  
RAL 7016 Anthracite grey

2300	1086	1086	1111	1111	1199	1310	1349	1383	1443
2125	1086	1086	1111	1111	1161	1254	1307	1341	1385
2000	1086	1086	1111	1111	1124	1199	1249	1300	1323
1750	1086	1086	1111	1111	1124	1199	1249	1300	1323
1500	1086	1086	1111	1111	1124	1199	1249	1300	1323
	1250	1500	1750	1900	2000	2250	2500	2750	3000

Clear width (LB) = ordering size

Only available in the priced size range listed! (Minimum production dimension BR 1250 x 1500 mm)

### Prices for internal roller garage doors



Exterior  
Decopaint Golden Oak\* or  
Noir 2100 Sablé (Anthracite metallic)

2300	1140	1151	1187	1193	1286	1408	1457	1502	1575
2125	1136	1147	1182	1188	1242	1344	1407	1452	1508
2000	1134	1143	1177	1182	1200	1284	1344	1404	1438
1750	1127	1136	1169	1174	1190	1273	1331	1391	1423
1500	1121	1128	1161	1165	1181	1262	1320	1378	1409
	1250	1500	1750	1900	2000	2250	2500	2750	3000

Clear width (LB) = ordering size

\* Painted in timber design look on inside and outside

Only available in the priced size range listed! (Minimum production dimension BR 1250 x 1500 mm)

Accessory	Description	Part no.		£
	<b>RollMatic TDL hand transmitter</b> Impulse, Incl. battery 433.92 MHz Battery: 3 V / type: 2025 Dimensions (W x H x D): 28 x 58 x 25mm	RSC2	Each	42

### Important product information

Please note that the RollMatic TDL cannot be fitted to a garage without alternate access.

# Garage Door Operators

## Operator Accessories







### Garage door operators

Boom Length	SupraMatic E	SupraMatic P	SupraMatic HT	ProMatic	ProMatic Akku
K	471	503	For prices and specification see the 01-16 A Price List	374	634
M	488	519		391	651
L	578	610		481	741

Hand transmitters with BiSecur technology are backwards compatible, i.e. they can also be used with series 1 and 2 operators (868 MHz). Hand transmitter 868 MHz BiSecur, incl. battery (Range of radio signal depends on local conditions)

- Possible
- Only in combination with a BiSecur radio receiver
- Only in conjunction with the BiSecur radio receiver ESE, status query possible
- Not possible

Garage door operators				
SupraMatic E/P	SupraMatic HT	ProMatic	ProMatic Akku	RollMatic

Accessory	Description					
<b>HS</b> 1-button hand transmitter  // NEW Black <b>HS 1 BS</b> Art. no. 4511720 £ 54	<b>Textured plastic surface with chrome-plated zinc die-cast caps</b> <ul style="list-style-type: none"> <li>• Impulse</li> <li>• Protection category: for dry rooms only</li> <li>• Temperature range: -20 °C to +60 °C</li> <li>• Battery: 1.5 V LR03 / AAA</li> <li>• Dimensions: 38 × 95 × 16 mm</li> </ul>	●	○	●	●	●
<b>HS</b> 4-button hand transmitter  // NEW Black <b>HS 4 BS</b> Art. no. 4511724 £ 56	<b>Textured plastic surface with chrome-plated zinc die-cast caps</b> <ul style="list-style-type: none"> <li>• Impulse</li> <li>• Protection category: for dry rooms only</li> <li>• Temperature range: -20 °C to +60 °C</li> <li>• Battery: 1.5 V LR03 / AAA</li> <li>• Dimensions: 38 × 95 × 16 mm</li> </ul>	●	○	●	●	●
<b>HS</b> 5-button hand transmitter  Black <b>HS 5 BS</b> Art. no. 436946 £ 68	<b>Textured plastic surface with chrome-plated zinc die-cast caps</b> <ul style="list-style-type: none"> <li>• Impulse</li> <li>• Status query</li> <li>• Protection category: for dry rooms only</li> <li>• Temperature range: -20 °C to +60 °C</li> <li>• Battery: 1.5 V LR03 / AAA</li> <li>• Dimensions: 38 × 95 × 16 mm</li> </ul>	●	□	●	-	-
<b>HS</b> 5-button hand transmitter   Black <b>HS 5 BS</b> Art. no. 436752 £ 74	<b>High gloss plastic surface with chrome-plated zinc die-cast caps</b> <ul style="list-style-type: none"> <li>• Impulse</li> <li>• Status query</li> <li>• Protection category: for dry rooms only</li> <li>• Temperature range: -20 °C to +60 °C</li> <li>• Battery: 1.5 V LR03 / AAA</li> <li>• Dimensions: 38 × 95 × 16 mm</li> </ul>	●	□	●	-	-

# Garage Door Operators

## Operator Accessories



Hand transmitters with BiSecur technology are backwards compatible, i.e. they can also be used with series 1 and 2 operators (868 MHz). Hand transmitter 868 MHz BiSecur, incl. battery (Range of radio signal depends on local conditions)

- Possible
- Only in combination with a BiSecur radio receiver
- Only in conjunction with the BiSecur radio receiver ESE, status query possible
- Not possible

Accessory		Description	Garage door operators				
			SupraMatic E/P	SupraMatic HT	ProMatic	ProMatic Akku	RollMatic
<b>HSS</b> 4-button security hand transmitter  Red <b>HSS 4 BS</b> Art. no. 436756 £ 92		<b>High gloss plastic surface in red with chrome-plated zinc diecast caps</b> <ul style="list-style-type: none"> <li>• Impulse</li> <li>• Additional function: Copy protection for hand transmitter coding (e.g. property management)</li> <li>• Protection category: for dry rooms only</li> <li>• Temperature range: -20 °C to +60 °C</li> <li>• Battery: 1.5 V LR03 / AAA</li> <li>• Dimensions: 38 x 95 x 16 mm</li> </ul> <b>Note:</b> Not downward compatible	●	○	●	○	●
<b>Accessories</b> For hand transmitters (HS and HSS) // NEW  Black      Black (textured surface)*      White <b>Hand transmitter station</b> Art. no. 436691      437077      436692 £ 11      11      11		<ul style="list-style-type: none"> <li>• For HS 1 BS, HS 4 BS, HS 5 BS, HSS 4 BS</li> </ul> * The hand transmitter station in black with textured surface is available from autumn 2016.					
For hand transmitters (HS and HSS)  <b>Hand transmitter holder</b> Transparent, incl. visor clip Art. no. 436698 £ 9		<ul style="list-style-type: none"> <li>• For HS 1 BS, HS 4 BS, HS 5 BS, HSS 4 BS</li> <li>• For wall fitting or for fitting to the visor clip</li> <li>• Without fitting material</li> </ul>					
<b>HSE</b> 1-button hand transmitter  Black <b>HSE 1 BS</b> Art. no. 4511728 £ 54		<b>Textured plastic surface with chrome-plated zinc die-cast caps</b> <ul style="list-style-type: none"> <li>• Impulse</li> <li>• Incl. key ring for fastening to the key chain</li> <li>• Protection category: for dry rooms only</li> <li>• Temperature range: 0 °C to +60 °C</li> <li>• Battery: Lithium round cell 3 V / type CR 2032</li> <li>• Dimensions: 28 x 70 x 14 mm</li> </ul>	●	○	●	●	●
<b>Accessories</b> For hand transmitter holder // NEW  <b>Walker/wheelchair hand transmitter holder</b> Art. no. 437022 £ 9		<ul style="list-style-type: none"> <li>• For hand transmitter holder HS and HSE</li> <li>• For the easy fastening of the hand transmitter holder to walkers or wheelchairs</li> <li>• Dimensions (W x H x D): 68 x 15 x 14 mm</li> </ul> <b>Note:</b> Also suitable for fitting on bicycle handlebars, motorcycle handlebars or tubular frame.					





# Garage Door Operators

## Operator Accessories



Hand transmitters with BiSecur technology are backwards compatible, i.e. they can also be used with series 1 and 2 operators (868 MHz). Hand transmitter 868 MHz BiSecur, incl. battery (Range of radio signal depends on local conditions)

- Possible
- Only in combination with a BiSecur radio receiver
- Only in conjunction with the BiSecur radio receiver ESE, status query possible
- Not possible

Accessory		Description	Garage door operators				
			SupraMatic E/P	SupraMatic HT	ProMatic	ProMatic Akku	RollMatic
<b>HSE</b>	2-button hand transmitter	<b>High gloss plastic surface with chrome-plated zinc die-cast caps</b> <ul style="list-style-type: none"> <li>• Impulse</li> <li>• Incl. key ring for fastening to the key chain</li> <li>• Protection category: for dry rooms only</li> <li>• Temperature range: 0 °C to +60 °C</li> <li>• Battery: Lithium round cell 3 V / type CR 2032</li> <li>• Dimensions: 28 x 70 x 14 mm</li> </ul>					
	 <p>Black</p> <p><b>HSE 2 BS</b></p> <p>Art. no. 436754</p> <p>£ <b>59</b></p>	 <p>White</p> <p><b>HSE 2 BS</b></p> <p>Art. no. 436755</p> <p>£ <b>59</b></p>					
<b>HSE</b>	2-button hand transmitter HSE 2 BS		●	○	●	●	●
	Housing colour	Art. no. £					
	Purple	436869 <b>73</b>					
	Orange	436870 <b>73</b>					
	Yellow	436871 <b>73</b>					
	Red	436872 <b>73</b>					
	Green	436873 <b>73</b>					
	Carbon	436863 <b>73</b>					
	Silver	436864 <b>73</b>					
	Dark rootwood look	436866 <b>73</b>					
<b>HSE</b>	4-button hand transmitter	<b>Textured plastic surface with chrome-plated zinc die-cast caps</b> <ul style="list-style-type: none"> <li>• Impulse</li> <li>• Incl. key ring for fastening to the key chain</li> <li>• Protection category: for dry rooms only</li> <li>• Temperature range: 0 °C to +60 °C</li> <li>• Battery: Lithium round cell 3 V / type CR 2032</li> <li>• Dimensions: 28 x 70 x 14 mm</li> </ul>					
<b>// NEW</b>	 <p>Black</p> <p><b>HSE 4 BS</b></p> <p>Art. no. 4511732</p> <p>£ <b>56</b></p>		●	○	●	●	●
<b>HSE</b>	4-button hand transmitter	<b>Textured plastic surface with plastic caps</b> <ul style="list-style-type: none"> <li>• Impulse</li> <li>• Incl. key ring for fastening to the key chain</li> <li>• Protection category: for dry rooms only</li> <li>• Temperature range: 0 °C to +60 °C</li> <li>• Battery: Lithium round cell 3 V / type CR 2032</li> <li>• Dimensions: 28 x 70 x 14 mm</li> </ul>					
<b>// NEW</b>	 <p>Black</p> <p><b>HSE 4 BS</b></p> <p>Art. no. 4511736</p> <p>£ <b>54</b></p>		●	○	●	●	●
<b>Accessories</b>	For hand transmitter (HSE)	<ul style="list-style-type: none"> <li>• For HSE 1 BS, HSE 2 BS and HSE 4 BS</li> <li>• Transparent, incl. visor clip</li> <li>• For wall fitting or for fitting to the visor clip</li> <li>• Without fitting material</li> </ul>					
	 <p><b>Hand transmitter holder</b></p> <p>Art. no. 437006</p> <p>£ <b>9</b></p>						







# Garage Door Operators

## Operator Accessories



Hand transmitters with BiSecur technology are backwards compatible, i.e. they can also be used with series 1 and 2 operators (868 MHz). Hand transmitter 868 MHz BiSecur, incl. battery (Range of radio signal depends on local conditions)

- Possible
- Only in combination with a BiSecur radio receiver
- Only in conjunction with the BiSecur radio receiver ESE, status query possible
- Not possible

Accessory		Description	Garage door operators				
			SupraMatic E/P	SupraMatic HT	ProMatic	ProMatic Akku	RollMatic
<b>HSP</b>	4-button hand transmitter	<ul style="list-style-type: none"> <li>Impulse</li> <li>With sliding switch as a button lock-out</li> <li>Incl. key ring</li> <li>Protection category: for dry rooms only</li> <li>Temperature range: -20 °C to +60 °C</li> <li>Battery: Lithium round cell 3 V / type CR 2025</li> <li>Dimensions (D x H): Ø 48 x 13 mm</li> </ul>	●	○	●	●	●
 <p>Black</p> <p><b>HSP 4 BS</b></p> <p>Art. no. 436776</p> <p>£ <b>62</b></p>							
<b>HSD</b>	2-button hand transmitter	<ul style="list-style-type: none"> <li>Impulse</li> <li>High-quality metal housing</li> <li>As a key ring</li> <li>Protection category: for dry rooms only</li> <li>Temperature range: 0 °C to +60 °C</li> <li>Battery: Lithium round cell 3 V / type CR 2025</li> <li>Dimensions (W x H x D): 32 x 66 x 13 mm</li> </ul>	●	○	●	●	●
 <p>Aluminium</p> <p><b>HSD 2-A BS</b></p> <p>Art. no. 436774</p> <p>£ <b>76</b></p>		 <p>Chrome</p> <p><b>HSD 2-C BS</b></p> <p>Art. no. 436775</p> <p>£ <b>76</b></p>					
<b>HSZ</b>	1-button hand transmitter	<ul style="list-style-type: none"> <li>Impulse</li> <li>For insertion in a vehicle cigarette lighter</li> <li>Protection category: for dry rooms only</li> <li>Temperature range: -20 °C to +60 °C</li> <li>Battery: Lithium 3 V / type CR 2</li> <li>Dimensions (D x H): Ø 29 x 39 mm</li> </ul>	●	○	●	●	●
	2-button hand transmitter						
 <p>Black</p> <p><b>HSZ 1 BS</b></p> <p>Art. no. 436779</p> <p>£ <b>51</b></p>		 <p>Black</p> <p><b>HSZ 2 BS</b></p> <p>Art. no. 436782</p> <p>£ <b>51</b></p>					
<b>Batteries</b>							
<b>HNA</b>	Emergency battery	<ul style="list-style-type: none"> <li>Emergency power supply to bypass power failures up to 18 hours and max. 5 door cycles (depending on temperatures, situation of charge etc.)</li> <li>To be fixed on operator or garage ceiling</li> <li>Protection category: for dry rooms only</li> <li>Weight: approx. 2.3 kg</li> <li>Operating voltage: 24 V DC / 2.3 Ah</li> <li>Dimensions (W x H x D): 150 x 70 x 90 mm</li> </ul> <p>Also suitable for series 2 SupraMatic and ProMatic operators.</p>	●	●	●	-	●
 <p><b>HNA 18-3</b></p> <p>Art. no. 437726</p> <p>£ <b>141</b></p>							
<b>HNA</b>	Emergency battery	<ul style="list-style-type: none"> <li>Emergency power supply to bridge power outages</li> <li>Universal fixing for wall and floor fitting</li> <li>Double LED function display</li> <li>Protection category: IP 65</li> <li>Weight: approx. 3 kg</li> <li>Dimensions: 213 x 143 x 96 mm</li> <li>Battery voltage: 24 V DC / 2.3 Ah</li> </ul> <p>For RotaMatic / P / PL from autumn 2010 and for LineaMatic / P / H from year of manufacture 10 / 2009.</p>	-	-	-	-	-
 <p><b>HNA Outdoor</b></p> <p>Art. no. 436522</p> <p>£ <b>148</b></p>							

# Garage Door Operators

## Operator Accessories







Hand transmitters with BiSecur technology are backwards compatible, i.e. they can also be used with series 1 and 2 operators (868 MHz). Hand transmitter 868 MHz BiSecur, incl. battery (Range of radio signal depends on local conditions)

- Possible
- Only in combination with a BiSecur radio receiver
- Only in conjunction with the BiSecur radio receiver ESE, status query possible
- Not possible

### Garage door operators

SupraMatic E/P	SupraMatic HT	ProMatic	ProMatic Akku	RollMatic
----------------	---------------	----------	---------------	-----------

### Radio internal push button / internal receiver

<p><b>FIT</b> 1-button radio internal push button</p>  <p>Art. no. <b>FIT 1 BS</b> 439740 £ <b>89</b></p>	<ul style="list-style-type: none"> <li>• Impulse</li> <li>• Protection category: for dry rooms only</li> <li>• Temperature range: -20°C to +60°C</li> <li>• Battery: 2 x 1.5 V LR03/AAA</li> <li>• Colour: Pure white RAL 9010</li> <li>• Dimensions (W x H x D): 80 x 80 x 15 mm</li> </ul>	●	○	●	●	●
<p><b>FIT</b> 4-button radio internal push button</p>  <p>Art. no. <b>FIT 4 BS</b> 439741 £ <b>89</b></p>	<ul style="list-style-type: none"> <li>• Impulse</li> <li>• Protection category: for dry rooms only</li> <li>• Temperature range: -20°C to +60°C</li> <li>• Battery: 2 x 1.5 V LR03/AAA</li> <li>• Colour: Pure white RAL 9010</li> <li>• Dimensions (W x H x D): 80 x 80 x 15 mm</li> </ul>	●	○	●	●	●
<p><b>FIT</b> 5-button radio internal push button</p>  <p>Art. no. <b>FIT 5 BS</b> 439742 £ <b>103</b></p>	<ul style="list-style-type: none"> <li>• Impulse</li> <li>• Status query</li> <li>• Protection category: for dry rooms only</li> <li>• Temperature range: -20°C to +60°C</li> <li>• Battery: 2 x 1.5 V LR03/AAA</li> <li>• Colour: Pure white RAL 9010</li> <li>• Dimensions (W x H x D): 80 x 80 x 15 mm</li> </ul>	●	□	●	-	-
<p><b>FES</b> Radio receiver electric socket</p>  <p>Art. no. <b>FES 1</b> 439762 £ <b>95</b></p>	<ul style="list-style-type: none"> <li>• To switch the light and further consumers on/off</li> <li>• Functions: impulse, on and off, status feedback</li> <li>• Protection category: IP 20</li> <li>• Stand by: &lt; 0.5 W</li> <li>• Temperature range: -20 °C to +35 °C</li> <li>• Operating voltage: 100 - 240 V AC</li> <li>• Electric socket switching capacity:                             <ul style="list-style-type: none"> <li>- 2500 W / 10 A resistivity</li> <li>- 500 W inductive load</li> </ul> </li> <li>• Colour: Pure white RAL 9010</li> <li>• Dimensions (W x H x D): 80 x 80 x 67 mm</li> </ul>					
<p><b>FES</b> Radio receiver electric socket</p>  <p>Art. no. <b>FES 1-1 BS</b> 439763 £ <b>95</b></p>	<ul style="list-style-type: none"> <li>• For Hörmann door operators and operators of other makes to switch lights and other consumers on and off</li> <li>• Functions:                             <ul style="list-style-type: none"> <li>- Impulse, on and off, status feedback</li> <li>- Impulse for door operator, without operator status feedback</li> </ul> </li> <li>• Protection category: IP 20</li> <li>• Stand by: &lt; 0.5 W</li> <li>• Temperature range: -20 °C to +35 °C</li> <li>• Operating voltage: 100 - 240 V AC</li> <li>• Electric socket switching capacity:                             <ul style="list-style-type: none"> <li>- 2500 W / 10 A resistivity</li> <li>- 500 W inductive load</li> </ul> </li> <li>• Impulse output switching capacity: 24 V / max. 110 mA</li> <li>• With connecting lead 1 x 2 m, 2-wire</li> <li>• Colour: Pure white RAL 9010</li> <li>• Dimensions (W x H x D): 80 x 80 x 67 mm</li> </ul>					

# Garage Door Operators

## Operator Accessories



Hand transmitters with BiSecur technology are backwards compatible, i.e. they can also be used with series 1 and 2 operators (868 MHz). Hand transmitter 868 MHz BiSecur, incl. battery (Range of radio signal depends on local conditions)

- Possible
- Only in combination with a BiSecur radio receiver
- Only in conjunction with the BiSecur radio receiver ESE, status query possible
- Not possible

### Garage door operators

SupraMatic E/P	SupraMatic HT	ProMatic	ProMatic Akku	RollMatic
----------------	---------------	----------	---------------	-----------

### Radio internal push button 868 MHz BiSecur, incl. battery (Range of radio signal depends on local conditions)

**FIT** Radio internal push button



**FIT 2 BS**

Art. no. 436757  
£ 56

- With 2 impulse push buttons for control of 2 operators by radio signal
- One additional button for On / Off function of connected command units
- Connection option for max. 2 control elements (volt-free contact) e.g. key switch
- Battery: 1.5 V LR03 / AAA
- Temperature range: 0°C to +60°C
- Protection category: IP 20, for dry rooms only
- Dimensions (W x H x D): 30 x 110 x 35 mm

● ○ ● ● ●

**IT 3b** Internal push buttons



**IT 3b**

Art. no. 436204  
£ 36

- With illuminated impulse button, additional buttons for light on / off and operator on / off
- With 7 m connecting lead, 2-wire
- Protection category: IP 20, for dry rooms only
- Dimensions (W x H x D): 80 x 110 x 30 mm

● ● - - -

**FCT 3 BS** Radio code switch



**FCT 3 BS**

Art. no. 436758  
£ 91

- Impulse, for control of up to 3 door operators
- Transmission of up to 3 radio codes, 868 MHz
- Power supply: Battery 4 x 1.5 V LR03 / AAA
- **Illuminated keypad**, clip frame
- Protection category: IP 54
- Temperature range: -20°C to +60°C
- Housing: Plastic
- Dimensions (W x H x D): 80 x 135 x 40 mm

● ○ ● ● ●

**FCT 10 BS** Radio code switch



**FCT 10 BS**

Art. no. 436759  
£ 149

- Impulse, for control of up to 10 door operators
- Transmission of up to 10 radio codes, 868 MHz
- Power supply: Battery 4 x 1.5 V LR03 / AAA
- **Illuminated keypad**, sliding cover with metal embellishment
- Protection category: IP 54
- Temperature range: -20°C to +60°C
- Housing: Plastic
- Dimensions (W x H x D): 80 x 135 x 40 mm

● ○ ● ● ●

### Radio finger-scan 868 MHz BiSecur (range of radio signal depends on local conditions!)

**FFL** Radio finger-scan



**FFL 12 BS**

Art. no. 436788  
£ 193

- Impulse, to control 2 operators using a fingerprint
- Up to 12 fingerprints can be taught in, cannot be individually deleted
- Setting / programming via 3 buttons
- Housing: Plastic, sliding cover with metal embellishment
- Display via 3 LEDs
- Battery: 4 x 1.5 V LR03 / AAA
- Protection category: IP 54
- Temperature range: -20°C to +60°C
- Dimensions (W x H x D): 80 x 130 x 45 mm

● ○ ● ● ●

Only for use with Hörmann BiSecur 868 MHz receivers.



# Warranty

Hörmann products are manufactured to the highest quality standards and leave our factory only after rigorous quality testing. However, if you should have grounds for complaint, this section tells you what our door warranty offers, and how to go about making your claim.

In the unlikely event of a warranty claim becoming necessary, please contact the dealer or distributor who originally supplied your garage door. Your dealer should then supply details of the claim, together with a copy of the warranty card provided with the door and proof of purchase to the Product Services Department at Hörmann (UK) Ltd. To enable your claim under warranty to be processed as quickly as possible, you should provide the following details:

1. Your name, address and telephone number
2. Original invoice with date of purchase
3. Product description/door type and product number
4. Description of defect

An assessment of the claim will then be made. This may require Hörmann to inspect the product in-situ. In the event that there is no legitimate warranty claim under the terms specified herein, you may be liable for the costs of the inspection visit. We strongly recommend that you take note of the care and usage instructions displayed on the stickers on the back of your garage door, and on the page opposite, and that you follow these instructions throughout.

## Hörmann installers

Hörmann (UK) Ltd has a nationwide network of recommended installers who will be able to offer you a regular maintenance service on your garage door. Please call us on 01530 513050 for details of your nearest dealer.

## Hörmann (UK) Ltd Garage Door Warranty

<b>Warranty Period</b>	The purchaser is granted a warranty covering the safe and reliable function of the Hörmann garage door for a period of 10 years from the date of purchase. A 5 year warranty applies to springs, wire cables, track rollers, hinges and guide rollers. The warranty period for replacement parts is 6 months or to the end of the current warranty period, whichever is longer. In the case of foil-coated timber-effect, a warranty of 5 years is granted, for timber and GRP doors a warranty of 2 years is granted on the door panels alone under the terms and conditions specified herein. The door mechanism and steel frame (if applicable) is covered by the 10 year warranty period.
<b>Requirements</b>	Warranty claims are only applicable in the country where the garage door was purchased. The product must have been purchased through our authorised distribution channels. The warranty only covers damage to the contract object. The fully completed warranty card together with the receipt of purchase correspondingly dated substantiates your right to claim under the warranty.
<b>Performance</b>	During the warranty period we undertake to rectify any and all defects to the Hörmann product which can be proved to be attributed to a material or manufacturing fault. We pledge at our discretion either to exchange the defective merchandise for faultless merchandise, repair it or allow a reduction in price. We do not accept costs for dismantling and installation nor for carriage. Replaced parts become our property. The warranty does not cover damage caused through: <ul style="list-style-type: none"><li>• normal wear and tear</li><li>• improper installation</li><li>• negligent care and maintenance</li><li>• improper initial and subsequent operation</li><li>• negligent or wanton destruction</li><li>• external influences such as fire, water, salts, alkaline solutions, acids, abnormal environmental influences</li><li>• mechanical damage through improper transport and fitting</li><li>• priming and other surface protection treatments</li><li>• incorrect or too late applied surface protection treatments</li><li>• repair by non-qualified persons</li><li>• using non-Hörmann parts without the approval of the manufacturer</li><li>• removal of the product number or making it unidentifiable</li></ul>

## Electric Operator Warranty

A separate 5 year warranty is granted on our electric operators. This includes operator mechanics, motor and motor control systems. A 2 year warranty is granted on radio equipment, accessories and system controls. There is no warranty on consumables (e.g. fuses, batteries, bulbs etc.). For further details please contact us on 01530 513030 or through our website on [www.hormann.co.uk](http://www.hormann.co.uk)

## User Information/Care

### Finish – Steel Doors

The coating process applied to the door and chassis is environmentally friendly. Minor scratches or marks are not covered under the conditions of our warranty and should be repaired immediately to prevent corrosion and deterioration of the panel. Corrosive substances such as acids, alkalines, and salts, etc. should be cleaned from the door immediately; failure to do so will result in deterioration of the finish, which will not be covered under our warranty. Should deterioration of the finish start to occur you will need to repaint your door immediately. Prepare the surface lightly with wet and dry. Then treat with solvent based 2 pack epoxy wash primer and a normal commercial paint (cellulose paint must not be used). Hörmann steel doors are a finished product. They do not require re-painting on site. They are however not immune to damage, which can occur at any stage of the handling of the product from factory to site.

### Finish – Timber Doors

Timber panels are coated with a neutralising base-stain. Doors must be stored upright, under cover, with wrapping intact, until wrapping is removed. As soon as the door is unwrapped, one coat of a good quality basecoat primer must be applied to both sides of the door. Immediately after installation, your timber doors require a further two coats of a good quality exterior wood finish on both sides. Initial application and periodic treatment should be carried out strictly in accordance with the woodstain manufacturer's instructions. Failure to follow these instructions will result in early deterioration of the timber panel.

### Finish – GRP Doors

GRP door panels should periodically be washed down using water. This should be done more frequently if fitted near the sea. Bird droppings will bleach the finish on GRP and should be removed using water as soon as possible. GRP doors should not be painted over.

### Paint Finish – Steel Doors

Minor surface damage can easily be repaired using touch up sprays or sticks without invalidating warranties.

The following document was designed by the Association of Garage Door Specialists, updated by the DHF and endorsed by all major UK garage door manufacturers, as a guide for purchasers of domestic garage doors.

## Visual appearance of Garage Doors

A new garage door can be a significant investment that will transform the appearance of your home. This information is a guide to the quality you can expect.

## The Quality Check

The quality check should be carried out in natural daylight, not direct sunlight. Stand at a distance of 3 metres from the door to view the overall appearance. The door is acceptable if, taking into account the facts below, none of the following are readily visible on the face of the door:

- Marks or distortion associated with the manufacturing process
- Minor indentations, marks or scuffs on the surface
- Paint or stain blemishes

## The Facts

### Steel Doors

**Panel Distortion** The rolling or pressing of steel panels during manufacture will cause distortion in the steel and while every effort is made to keep this to a minimum, inevitably some visible distortion will remain. The application of high gloss paints will make this slight distortion more apparent, especially under certain lighting conditions, such as car headlamps, or bright sunshine.

**Paint Finish** Primed doors – the primer coating is applied as a base coat only and as such requires additional finishing with a good quality exterior paint. Any marks or scratches on the primer coat should be rubbed down and repainted as part of this finishing process.

**Timber Doors** Finished doors – the factory application of the paint finish is an automated process and this may result in minor blemishes or slight inconsistencies in the paint, particularly in the area of panel joints.

### Timber

Timber is a natural product and there will be variations in pattern, colour, shading and grains. No two doors will be the same, because wood naturally expands and contracts according to environmental conditions, joints will open and close and some minor curvature may occur.

It is vital that timber doors are fully finished as per the manufacturers instructions before exposure to the elements.

### GRP and Composite Plastic Doors

**Mould Marks** GRP doors are individually handcrafted in a mould and are then hand finished. Some minor marks and blemishes will inevitably remain after this process.

**Translucency** When viewed from the inside, it is often possible to see variations in the translucency of the door, particularly around and between areas of relief. Such variations do not detract from the overall strength or build quality of the door.

### All Doors

**Colour Match** Pairs of doors should be ordered together to obtain the best colour match, bearing in mind the limitations of the materials used in the construction. Timber garage doors cannot be ordered as matching sets.

**Size Variation** As the size of a door changes in height and/or width, the panel frequency and profile can change, therefore doors of the same style but of different sizes can be significantly different in appearance.

**Clearances** All doors require operating clearances, i.e. the gap between the door panel and the frame opening, these are inbuilt during manufacture and should not be reduced by means of infills, or draughtproofing.

**Deflection** When in the open position, all doors will display a level of vertical deflection or “sag” across the width of the panel. Individual manufacturers' specifications should be consulted for exact tolerances.

### Power Operated Garage Doors

It is against the law to install a power operated garage door in the UK without complying with the Machinery Directive.

To comply with the Machinery Directive both the door and the operator used in the installation must have a Declaration of Incorporation from the manufacturer.

On completion of the installation the installer must provide a Declaration of Conformity and apply a CE mark giving details of the installation to the door/operator combination, which is now classed as a machine.

The installer must issue to the customer a Declaration of Conformity on completion of the installation.

The installer must hold copies of both the Declaration of Incorporation and the Declaration of Conformity on a technical file for inspection by the relevant authorities.

If any of the above requirements are not fulfilled the installation is illegal.

Please ensure for your own safety and peace of mind that whoever installs your electric operator is both willing and able to fulfil these requirements; if they are not – do not use them!

Members of the DHF Garage Door Installer Group can and will install your Hörmann operator safely and legally.

Since the company's policy is one of continuous improvement of its products, we reserve the right to make any alterations in design, manufacture or price. All business is governed by the company's Standard Conditions and this document does not form any part of any contract with the company and statements contained in it should not be construed as representations or warranties.

# Hörmann: Quality without Compromise



Hörmann KG Amshausen, Germany



Hörmann KG Antriebstechnik, Germany



Hörmann KG Brandis, Germany



Hörmann KG Brockhagen, Germany

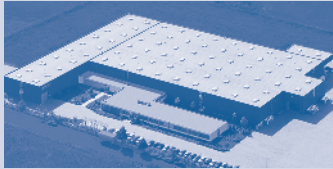

Hörmann KG Dissen, Germany



Hörmann KG Eckelhausen, Germany



Hörmann KG Freisen, Germany



Hörmann KG Ichtershagen, Germany



Hörmann KG Werne, Germany



Hörmann Genk NV, Belgium



Hörmann Alkmaar B.V., Netherlands



Hörmann Legnica Sp. z.o.o., Poland



Hörmann Beijing, China



Hörmann Tianjin, China

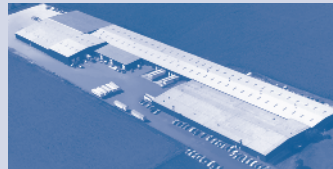

Hörmann LLC, Montgomery IL, USA



Hörmann Flexon, Leetsdale PA, USA

Hörmann is the only manufacturer worldwide that offers you a complete range of all major building products from one source. We manufacture in highly-specialised factories using the latest production technologies. The close-meshed network of sales and service companies throughout Europe, and activities in the USA and China, make Hörmann your strong partner for first-class building products, offering "Quality without Compromise".

**GARAGE DOORS**

**OPERATORS**

**INDUSTRIAL DOORS**

**LOADING EQUIPMENT**

**HINGED DOORS**

**DOOR FRAMES**

Hörmann (UK) Ltd  
Gee Road  
Coalville  
Leicestershire  
LE67 4JW

Tel: 01530 513000  
Fax: 01530 513001

[www.hormann.co.uk](http://www.hormann.co.uk)

**HÖRMANN**