

Cardale guarantees

Guarantees are subject to the conditions as set out below;

1. During the comprehensive 2 year guarantee period Cardale Doors undertake to repair or replace (at its discretion), and without charge, products or components which have suffered any form of manufacturing defect. Claims must be notified within 3 days from the date of delivery or within a reasonable time after discovery of any defect.
2. Products covered by these guarantees must have been purchased through an authorised Cardale garage door distributor or as original equipment attached to a newly built dwelling.
3. The warranties shall apply for normal use only. Normal use constitutes no more than 5 operations (open/close cycles) per day.
4. The warranties offered attach to the Cardale product only and no consequential damages will apply no matter how caused.
5. No liability will be accepted as a result of normal wear and tear, incorrect storage, incorrect handling, faulty installation, incorrect use or wilful damage.
6. Claims under this guarantee must be made through the original supplier and accompanied by relevant documentation indicating the date of purchase (e.g. receipt).
7. Cardale Doors maximum liability shall be the original purchase price inclusive of Value Added Tax at the rate prevailing when supplied.
8. Any product which is the subject of a claim:
 - i) must have been correctly installed in accordance with the installation instructions supplied and thereafter properly maintained by a suitably experienced engineer on a regular basis as set out in the Maintenance and Operating Instructions provided with every door. (Additional copies of these instructions are available by calling 0871 231 75 70). We recommend that regular maintenance is provided by a suitably experienced engineer. Contact us on www.cardale.com to find your local Cardale garage door specialist.
 - ii) must have the manufacturer's reference number still intact (found on the barcode label on the door)
 - iii) must not have been modified in any way.

A Service Passport is supplied with every Cardale garage door and this document contains useful information on how to look after your door. It also includes a Service Record section in which to record each time your door receives regular routine servicing. This record will be useful in the unlikely event of a claim under this guarantee.

9. Claims will not be accepted where the cause is due to:
 - i) impact or mechanical damage suffered during or following installation, e.g scratches, indentations, tears, scuffs or other surface abrasion.
 - ii) damage or discolouration caused by contact with any form of caustic, abrasive or corrosive substance, fumes, bird droppings, fire, smoke, floodwater, salts, acids, or from exposure to abnormal atmospheric pollution.
10. This guarantee excludes normal wear and tear on items such as cones, cables, spindles, lock cylinders, hinges or springs.
11. Only Cardale original spare parts must be used when required. The use of non-Cardale parts shall invalidate this guarantee. Warranty period for replacement parts is 6 months or the balance of the original warranty period if greater.
12. The Exterior Finish Guarantee applies only to the weatherside surface and where more than 5% of the surface area of the door is affected. Surfaces must be freely exposed to washing by rainfall and kept clear of accumulated dirt and debris and given equal exposure to local environmental conditions and consistent natural lighting conditions across the face of the door. Special attention is drawn to Clause (9) (ii).
13. Primed steel doors and basecoat treated timber doors must receive a suitable exterior quality finishing topcoat immediately after installation. This topcoat finish must be applied strictly in accordance with the manufacturer's instructions.
14. Cardale timber doors are guaranteed against any form of manufacturing defect or mechanical failure for a period of 2 years from the date of original purchase. The exterior factory fully finished panel is guaranteed to provide a weatherproof membrane which will resist perforation of the substrate from the weather side due to corrosion for a period of up to 5 years, dependent on location and position of the door and provided the door has been maintained in accordance with the manufacturer's instructions.
15. The guarantee period for electric operators excludes batteries, fuses and light bulbs.
16. Parts replaced free of charge become the property of Cardale Doors.
17. Attempted repairs by non-qualified individuals shall invalidate this guarantee.
18. Cardale garage doors and associated products are sold subject to the Cardale Doors Standard Terms and Conditions of Sale, copies of which are available upon request. Cardale Doors shall not be liable as a result of any representation, implied warranty or other term or condition or for any consequential loss or damage, costs, expenses or other claims whatsoever except as expressly set out in these Terms and Conditions of Sale.
19. All colour samples depicted in this brochure are as close to the original manufacturer's colour as possible. Garage doors supplied may vary in colour from the brochure representation.



new ranges and styles



For more information or to request a brochure on any of Cardale's ranges of Garage Doors and accessories, contact:

Cardale Garage Doors
Unit 6, Dalroad Enterprise Estate, Dallow Road
Luton, LU1 1SP, UK
Tel: 0845 026 80 44
Fax: 0845 026 80 47
www.cardale.com

Cardale reserves the right to alter specifications to design and manufacture without notification. All specifications are correct at time of publication, errors and omissions excepted.

Garage Door Range
Price List
August 2011



Welcome..

..to Cardale's price list containing comprehensive pricing details for our inspirational range of high quality doors. Cardale is British owned and we have been manufacturing garage doors for over forty years. We are sure you'll find exactly the right door for your home amongst Cardale's range - no one offers more choice!

Our doors represent the best, not only in looks, but also in terms of safety, security and durability. Cardale has no doubt that, in years to come, you will still be as happy with your Cardale door as the day it is installed.

For technical help and information please visit www.cardale.com

Not sure what style?

Visit Cardale's 'try a door' at www.tryadoor.com to see how any door from Cardale's wide range will look either in one of the six house styles or, even better, on a photo of your own home.

Invaluable if you have trouble making up your mind, or if you cannot imagine the impact a new door will make to your home.

Where to buy

Cardale doors are available through a network of independent garage door specialists who will be able to provide full details and prices for our range. Visit www.cardale.com or call **0845 026 80 44** for details of your nearest distributor.

Amongst the distributors are those achieving Gold Standard - visit www.golddistributor.co.uk or www.cardale.com for your nearest Gold Distributor.



Contents

Page

2	Introduction/contents	24	Timber doors - Futura (standard & made to measure double doors)
3	General Information	27	Timber doors - Heritage (standard & made to measure single doors)
4	White powder coated pre-finished steel doors (standard & made to measure single doors)	28	Timber doors - Heritage (standard & made to measure single doors + side hinged doors)
6	White powder coated pre-finished steel doors (standard double doors)	29	Timber doors - Heritage (standard & made to measure double doors)
8	White powder coated pre-finished steel doors (made to measure double doors)	31	White powder coated pre-finished steel doors (side hinged doors)
9	Plastisol doors (standard & made to measure single doors)	32	Golden Oak & Rosewood doors (side hinged doors)
11	Plastisol doors (standard double doors)	33	Plastisol doors (side hinged doors)
13	Plastisol doors (made to measure double doors)	35	ABS doors (side hinged doors)
14	Golden Oak & Rosewood doors (standard & made to measure single doors)	36	Timber doors - Futura (side hinged doors)
16	Golden Oak & Rosewood doors (standard double doors)	37	GRP doors
18	Golden Oak & Rosewood doors (made to measure double doors)	39	Personnel doors
19	ABS doors (standard single doors)	41	Steel line roller doors
20	ABS doors (made to measure single doors)	42	Thermaglide roller doors (77mm & 55mm insulated)
21	ABS doors (standard & made to measure double doors)	43	Sectional doors
22	Timber doors - Futura (standard & made to measure single doors)	45	Technical Information

INFORMATION FOR ALL DOORS

All products are sold subject to our standard conditions of sale, which are available on request and include the following:

PRICES

All orders are accepted on the understanding that the goods will be subject to the prices ruling at the time of delivery, unless other terms are specifically agreed. All prices are in £ sterling and exclude carriage and VAT.

PANEL CONFIGURATIONS

The proportions of the door's panel configurations may vary according to the actual size specified.

LOCK HANDLE POSITION

Lock handle position varies according to the design and the lifting gear type. As a general rule, lock handles are located two thirds of the way up SafeLift Trackless Canopy and one third of the way up Slideaway and vertically opening doors. Lock holes are supplied as standard on up & over, side hinged and Steel-line Roller doors unless specified at the time of order.

MADE TO MEASURE DOORS

Doors can be ordered in 1/2" increments.

DOOR DRAWINGS

Single door diagrams shown depict 7'0" x 7'0" doors. Double door diagrams shown depict 14'0" x 7'0" doors

SPECIFICATION

The Company reserves the right to make any alterations in design or manufacture without notification as is deemed necessary to ensure continual product development.

This document is intended for use as a price list only. For full product specifications and full details of extended product guarantees, please refer to the Cardale Range Guide or visit us at www.cardale.com.

TIMBER DOORS

The Company accepts no liability for natural variations in colour, warping, swelling or shrinkage due to ordinary natural processes of ageing, fading or the effects of weather or climate or shrinkage, warping or swelling which could have been prevented by carrying out finishing and maintenance as recommended by the Company.

All doors in the Futura, Heritage and Classic ranges are supplied with a two coat factory base coat stain treatment. These doors should be finished with a micro-porous stain, front and back, in accordance with the stain manufacturer's instructions immediately after fitting.

Prior to fitting they must not be stored in direct sunlight or exposed to splashes or rain as colour fading and staining may occur respectively.

Fully finished timber doors should be re-stained approximately every four years, regular inspections should be carried out and this period reduced as necessary.

Please note that timber is a beautiful material with naturally occurring colour and grain variations. Please tell us if you require matching pairs as we will do our best to match both doors.

GRP DOORS

GRP by definition, is manufactured from translucent strands of glass. This characteristic may occasionally show itself in translucency of the panel under bright external conditions when viewed from inside with the door closed, but this does not represent a defect in the construction or strength of the door.

Please note that our GRP doors are handcrafted. This may result in shade variations. Please tell us if you require doors to match and we will do our best to achieve as close a door match as possible.

SIDE HINGED DOORS & PERSONNEL DOORS

All doors will be supplied with locking and lock holes unless specified otherwise on order.

THERMAGLIDE

Due to manufacturing processes the bottom lath may vary in colour from the rest of the door. Your door will be Made to Measure to suit the dimensions given.

DELIVERY CHARGES

ALL DOORS

Delivery charges per door: 1 Door = £46.00 NETT 2 Doors = £39.00 (each door) NETT 3 Doors + = *free of charge

Mainland England, Scotland and Wales only*. Northern Ireland, Channel Islands, Isle of Man, and export delivery – charges on application. Carriage charges and VAT to be added to all prices. *Additional charges may be applied to remote rural locations - please contact for details.

PRODUCT APPEARANCE

Garage doors should be inspected upon delivery and viewed in natural daylight (not direct sunlight) from a standard distance of 3 metres to view their overall appearance. From this distance the door panel should appear free from visible marks or distortion, stains, blemishes, indentations or scuffs.

STORAGE

Garage doors should be stored in their original packaging stood upright on flat ground. Avoid placing on stony or uneven surfaces. Doors should always be lifted and not dragged into place.

Do not rest doors against each other without first placing protective packaging in between. Install as soon as possible once the goods have arrived on site.

CARE & MAINTENANCE ALL DOORS

Periodically clean the door panel using warm water and a soft cloth or sponge before allowing to dry naturally. Never use detergent, abrasive, caustic or solvent based cleaners as they may damage the door surface. Bird droppings should be removed immediately as these can be particularly caustic.

All doors should be operated and maintained in line with manufacturer's instructions - see operating and maintenance instructions supplied with your door. For further copies visit www.cardale.com.

CARDALE SERVICE PASSPORT

A Service Passport is supplied with every Cardale door installed. This document contains information on how to look after your door, with a Service Record section of the passport provided to record each time your door receives regular routine servicing.

In the unlikely event of a warranty claim, this document, if kept up to date and used correctly, can help to show that your door has been regularly serviced and properly maintained in accordance with warranty conditions.



Single door
Standard

Size mm (ft/in) Width by Height	Bedford		Berkeley (Vertical)		Brompton		Chevron		Europa II		Gatcombe		Gemini		Georgian		Haven		Olympian	
	C	R	C	R	C	R	C	R	C	R	C	R	C	R	C	R	C	R	C	R
1981 x 1981 (6'6" x 6'6")	-	-	-	-	645	686	-	-	445	486	-	-	506	547	645	686	557	598	645	686
1981 x 2134 (6'6" x 7'0")	-	-	-	-	658	699	-	-	457	492	-	-	507	548	658	699	558	599	658	699
2083 x 1905 (6'10" x 6'3")	-	-	-	-	624	665	-	-	458	500	-	-	519	560	624	665	571	612	624	665
2083 x 1930 (6'10" x 6'4")	-	-	-	-	624	665	-	-	461	503	-	-	519	560	624	665	571	612	624	665
2083 x 1956 (6'10" x 6'5")	-	-	-	-	624	665	-	-	468	509	-	-	528	570	624	665	580	621	624	665
2083 x 1981 (6'10" x 6'6")	-	-	-	-	624	665	-	-	475	516	-	-	528	570	624	665	580	621	624	665
2108 x 1981 (6'11" x 6'6")	-	-	-	-	624	665	-	-	475	516	-	-	528	570	624	665	580	621	-	-
2108 x 2134 (6'11" x 7'0")	-	-	-	-	624	665	-	-	475	516	-	-	528	570	624	665	580	621	-	-
2134 x 1828 (7'0" x 6'0")	-	-	-	-	624	665	-	-	475	516	-	-	531	573	624	665	583	624	-	-
2134 x 1880 (7'0" x 6'2")	-	-	-	-	624	665	-	-	475	516	-	-	531	573	624	665	583	624	-	-
2134 x 1905 (7'0" x 6'3")	-	-	-	-	624	665	-	-	475	516	-	-	531	573	624	665	583	624	624	665
2134 x 1930 (7'0" x 6'4")	-	-	-	-	624	665	-	-	475	516	-	-	531	573	624	665	583	624	-	-
2134 x 1981 (7'0" x 6'6")	857	898	857	898	622	663	504	545	432	473	857	898	504	545	622	663	515	555	622	663
2134 x 2134 (7'0" x 7'0")	862	903	862	903	657	698	518	559	469	510	862	903	578	559	657	698	575	616	657	698
2210 x 1930 (7'3" x 6'4")	-	-	-	-	697	739	-	-	491	533	-	-	556	597	697	739	608	649	697	739
2261 x 1981 (7'5" x 6'6")	-	-	-	-	721	762	-	-	491	533	-	-	568	609	721	762	590	631	721	762
2261 x 2134 (7'5" x 7'0")	-	-	-	-	852	893	-	-	570	611	-	-	626	667	852	893	659	700	852	893
2286 x 1828 (7'6" x 6'0")	-	-	-	-	697	739	-	-	494	536	-	-	551	592	697	739	603	644	-	-
2286 x 1905 (7'6" x 6'3")	-	-	-	-	697	739	-	-	494	536	-	-	551	592	697	739	603	644	697	739
2286 x 1981 (7'6" x 6'6")	889	930	889	930	702	744	550	591	493	535	889	930	550	591	702	744	590	631	702	744
2286 x 2134 (7'6" x 7'0")	892	933	892	933	821	862	604	645	564	606	892	933	604	645	821	862	659	700	821	862
2438 x 1905 (8'0" x 6'3")	-	-	-	-	852	893	-	-	545	586	-	-	629	671	840	882	681	722	852	893
2438 x 1930 (8'0" x 6'4")	-	-	-	-	840	882	-	-	570	611	-	-	648	689	840	882	699	741	840	882
2438 x 1981 (8'0" x 6'6")	942	984	942	984	840	882	-	-	570	611	942	984	648	689	852	893	699	741	840	882
2438 x 2134 (8'0" x 7'0")	943	985	943	985	897	938	-	-	581	622	943	985	676	717	852	893	727	768	897	938

Single door
Made to measure

Width (up to) mm (ft/in) Width by Height	Bedford		Berkeley (Vertical)		Brompton		Chevron		Europa II		Gatcombe		Gemini		Georgian		Haven		Olympian	
	C	R	C	R	C	R	C	R	C	R	C	R	C	R	C	R	C	R	C	R
1981 (6'6")	-	-	-	1078	761	802	-	-	554	595	-	1078	610	651	761	802	661	702	761	802
2134 (7'0")	-	1078	-	1078	760	801	-	-	572	613	-	1078	621	662	760	801	673	714	760	801
2286 (7'6")	-	1116	-	1116	924	965	-	-	667	709	-	1116	707	748	924	965	758	799	924	965
2438 (8'0")	-	1181	-	1181	1000	1041	-	-	684	725	-	1181	779	820	1000	1041	830	871	1000	1041

Size availability (mm)

Minimum width	-	2134	-	1829	1829	1829	-	-	1829	1829	-	1829	1829	1930	1930	1829	1829	1829	1829	
Maximum width	-	2438	-	2438	2438	2438	-	-	2438	2438	-	2438	2438	2438	2438	2438	2438	2438	2438	
Minimum height	-	1918	-	1918	1918	1918	-	-	1829	1918	-	1918	1829	1918	1931	1931	1829	1918	1905	1918
Maximum height	-	2286	-	2286	2134	2286	-	-	2134	2286	-	2286	2134	2286	2134	2134	2134	2286	2134	2286

Single door
Standard

Size mm (ft/in) Width by Height	Orion (Horizontal)		Orion (Vertical)		Vogue	
	C	R	C	R	C	R
1981 x 1981 (6'6" x 6'6")	645	686	645	686	598	640
1981 x 2134 (6'6" x 7'0")	658	699	658	699	599	641
2083 x 1905 (6'10" x 6'3")	624	665	624	665	612	653
2083 x 1930 (6'10" x 6'4")	624	665	624	665	612	653
2083 x 1956 (6'10" x 6'5")	624	665	624	665	621	662
2083 x 1981 (6'10" x 6'6")	624	665	624	665	621	662
2108 x 1981 (6'11" x 6'6")	624	665	624	665	621	662
2108 x 2134 (6'11" x 7'0")	624	665	624	665	621	662
2134 x 1828 (7'0" x 6'0")	624	665	624	665	624	665
2134 x 1880 (7'0" x 6'2")	624	665	624	665	624	665
2134 x 1905 (7'0" x 6'3")	624	665	624	665	624	665
2134 x 1828 (7'0" x 6'0")	624	665	624	665	624	665
2134 x 1981 (7'0" x 6'6")	622	663	622	663	602	643
2134 x 2134 (7'0" x 7'0")	657	698	657	698	620	661
2210 x 1930 (7'3" x 6'4")	697	739	697	739	649	690
2261 x 1981 (7'5" x 6'6")	721	762	721	762	644	685
2261 x 2134 (7'5" x 7'0")	852	893	852	893	696	737
2286 x 1828 (7'6" x 6'0")	697	739	697	739	644	685
2286 x 1905 (7'6" x 6'3")	697	739	697	739	644	685
2286 x 1981 (7'6" x 6'6")	702	744	702	744	696	737
2286 x 2134 (7'6" x 7'0")	821	862	821	862	696	737
2438 x 1905 (8'0" x 6'3")	852	893	852	893	722	763
2438 x 1930 (8'0" x 6'4")	840	882	840	882	741	782
2438 x 1981 (8'0" x 6'6")	840	882	840	882	741	782
2438 x 2134 (8'0" x 7'0")	897	938	897	938	768	810

Single door
Made to measure

Width (up to) mm (ft/in) Width by Height	Orion (Horizontal)		Orion (Vertical)		Vogue	
	C	R	C	R	C	R
1981 (6'6")	761	802	761	802	702	744
2134 (7'0")	760	801	760	801	714	755
2286 (7'6")	924	965	924	965	799	840
2438 (8'0")	1000	1041	1000	1041	871	913

Size availability (mm)

Minimum width	1829	1829	1829	1829	1829	1829
Maximum width	2438	2438	2438	2438	2438	2438
Minimum height	1829	1918	1829	1918	1829	1918
Maximum height	2134	2286	2134	2286	2134	2286

C = Canopy gear, R = Retractable gear.

Steel up and over single doors - options

Brass effect handle	add £46
Flush lock handle	add £36 (Gemini and Europa only)
Draught strip	add £31
Standard frame 54mm/68mm	add £98 (Pre-finished or white painted)
Coloured frame 54mm/68mm	add £134 (Coloured paint)
Cardale 650 operator	add £376
Canopy converter	add £98
Cardale 800 operator	add £487
Glazing (Bedford)	add £118 (Stippled) Black mock glazing standard
Glazing (Brompton)	add £248
Glazing (Georgian)	add £248
Painted door	add £61 (White) add £88 (Colours)
Colours available	White, Ebony Black, Balmoral Green, Oxford Blue, Conker Brown, Monarch Red, Metallic Grey, Grey, Midnight Blue, Anthracite, Cherry & Burgundy

Optional extras for operators

Extra handsets	add £56 (2 channel) add £62 (4 channel)
Wireless key pad	add £155
External manual override	add £36
Keyswitch	add £39

* Choice of 54mm or 68mm optional frame for canopy doors. 68mm optional frame only for retractable doors.

Please see page 31 for side hinged doors & options

Prices applicable to all available heights. (made to measure doors only)

Double door
Pre-finished



Size mm (ft/in)	Bedford	Brompton	Chevron	Europa II	Gemini
Width by Height	R	R	R	R	R
2743 x 1981 (9'0" x 6'6")	-	1054	-	812	812
2743 x 2134 (9'0" x 7'0")	-	1074	-	852	852
2896 x 1981 (9'6" x 6'6")	-	1207	-	917	917
2896 x 2134 (9'6" x 7'0")	-	1232	-	942	942
3048 x 1981 (10'0" x 6'6")	-	1261	-	1020	1020
3048 x 2134 (10'0" x 7'0")	-	1286	-	1020	1020
3200 x 1981 (10'6" x 6'6")	1264	1264	-	1124	1124
3200 x 2134 (10'6" x 7'0")	1284	1284	-	1139	1139
3353 x 1981 (11'0" x 6'6")	1305	1305	-	1149	1149
3353 x 2134 (11'0" x 7'0")	1326	1326	-	1165	1165
3505 x 1981 (11'6" x 6'6")	1346	1346	-	1186	1186
3505 x 2134 (11'6" x 7'0")	1367	1367	-	1201	1201
3658 x 1981 (12'0" x 6'6")	1387	1387	-	1216	1216
3658 x 2134 (12'0" x 7'0")	1408	1408	-	1232	1232
3810 x 1981 (12'6" x 6'6")	1429	1429	-	1247	1247
3810 x 2134 (12'6" x 7'0")	1449	1449	-	1263	1263
3962 x 1981 (13'0" x 6'6")	-	1549	-	1278	1278
3962 x 2134 (13'0" x 7'0")	-	1569	-	1294	1294
4115 x 1981 (13'6" x 6'6")	-	1549	-	1309	1309
4115 x 2134 (13'6" x 7'0")	-	1569	-	1325	1325
4267 x 1981 (14'0" x 6'6")	2017	1450	1380	1133	1133
4267 x 2134 (14'0" x 7'0")	2042	1450	1406	1159	1159
4420 x 1981 (14'6" x 6'6")	-	1579	-	1350	1350
4420 x 2134 (14'6" x 7'0")	-	1599	-	1366	1366
4572 x 1981 (15'0" x 6'6")	-	1599	-	1381	1381
4572 x 2134 (15'0" x 7'0")	-	1620	-	1397	1397
4877 x 1981 (16'0" x 6'6")	-	1850	-	1412	1412
4877 x 2134 (16'0" x 7'0")	-	1870	-	1428	1428

R = Retractable gear.

Steel up and over double doors - options

Brass effect handle	add £46
Flush lock handle	add £36 (Gemini and Europa only)
Draught strip	add £61
Standard frame 68mm	add £175 (Pre-finished or white painted)
Coloured frame 68mm	add £232 (Coloured painted)
Cardale 650 operator	add £376
Cardale 800 operator	add £487
Glazing (Bedford)	add £236 (Stippled) Black mock glazing standard
Glazing (Brompton)	add £496
Glazing (Georgian)	add £496

Painted door	add £93 (White) add £137 (Colours)
Colours available	White, Ebony Black, Balmoral Green, Oxford Blue, Conker Brown, Monarch Red, Metallic Grey, Grey, Midnight Blue, Anthracite, Cherry & Burgundy.

Double door
Pre-finished

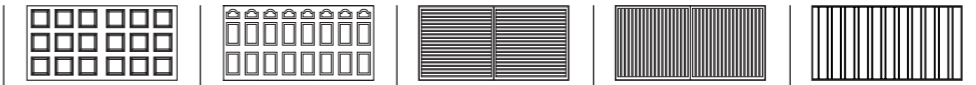





Size mm (ft/in)	Georgian	Olympian	Orion (Horizontal)	Orion (Vertical)	Vogue
Width by Height	R	R	R	R	R
2743 x 1981 (9'0" x 6'6")	1054	1142	-	-	1061
2743 x 2134 (9'0" x 7'0")	1074	1168	-	-	1087
2896 x 1981 (9'6" x 6'6")	1207	1261	-	-	1106
2896 x 2134 (9'6" x 7'0")	1232	1286	-	-	1132
3048 x 1981 (10'0" x 6'6")	1261	1379	-	-	1152
3048 x 2134 (10'0" x 7'0")	1286	1405	-	-	1177
3200 x 1981 (10'6" x 6'6")	1264	1434	-	-	1300
3200 x 2134 (10'6" x 7'0")	1284	1460	-	-	1326
3353 x 1981 (11'0" x 6'6")	1305	1489	-	-	1449
3353 x 2134 (11'0" x 7'0")	1326	1515	-	-	1475
3505 x 1981 (11'6" x 6'6")	1346	1556	-	-	1485
3505 x 2134 (11'6" x 7'0")	1367	1582	-	-	1511
3658 x 1981 (12'0" x 6'6")	1387	1624	-	-	1522
3658 x 2134 (12'0" x 7'0")	1408	1650	-	-	1548
3810 x 1981 (12'6" x 6'6")	1429	1715	-	-	1569
3810 x 2134 (12'6" x 7'0")	1449	1741	-	-	1594
3962 x 1981 (13'0" x 6'6")	1549	1806	-	-	1616
3962 x 2134 (13'0" x 7'0")	1569	1831	-	-	1642
4115 x 1981 (13'6" x 6'6")	1549	1863	-	-	1711
4115 x 2134 (13'6" x 7'0")	1569	1889	-	-	1737
4267 x 1981 (14'0" x 6'6")	1450	1771	2017	2017	1483
4267 x 2134 (14'0" x 7'0")	1450	1796	2042	2042	1509
4420 x 1981 (14'6" x 6'6")	1579	2017	-	-	1807
4420 x 2134 (14'6" x 7'0")	1599	2042	-	-	1832
4572 x 1981 (15'0" x 6'6")	1599	2143	-	-	1847
4572 x 2134 (15'0" x 7'0")	1620	2169	-	-	1873
4877 x 1981 (16'0" x 6'6")	1850	2270	-	-	2038
4877 x 2134 (16'0" x 7'0")	1870	2296	-	-	2064

Optional extras for operators

Extra handsets	add £56 (2 channel) add £62 (4 channel)
Wireless key pad	add £155
External manual override	add £36
Keyswitch	add £39

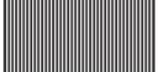
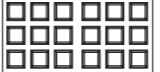
Double door
Pre-finished

Width (up to) mm (ft/in)	Width by Height						
		R	R	R	R	R	R
2591 (8'6")		1348	1088	1082	1348	1348	1267
2743 (9'0")		1348	1088	1082	1348	1348	1267
2896 (9'6")		1467	1201	1148	1467	1467	1312
3048 (10'0")		1585	1314	1280	1585	1585	1358
3200 (10'6")		1640	1380	1345	1640	1640	1506
3353 (11'0")		1695	1447	1371	1695	1695	1655
3505 (11'6")		1762	1506	1407	1762	1762	1691
3658 (12'0")		1830	1565	1438	1830	1830	1728
3810 (12'6")		1921	1608	1469	1921	1921	1775
3962 (13'0")		2012	1651	1500	2012	2012	1822
4267 (14'0")		2140	1695	1575	2140	2140	1689
4572 (15'0")		2349	-	1603	2349	2349	2053
4877 (16'0")		2476	-	1634	2476	2476	2244

Size availability (mm)

	Brompton	Europa II	Gemini	Georgian	Olympian	Vogue
Minimum width	1829	1829	1829	1829	1829	1829
Maximum width	4877	4267	4877	4877	4877	4877
Minimum height	1918	1918	1918	1931	1918	1918
Maximum height	2286	2286	2286	2134	2286	2286

Prices applicable to all available heights.

R = Retractable gear.

Steel up and over double doors - options









Brass effect handle	add £46
Flush lock handle	add £36 (Gemini and Europa only)
Draught strip	add £61
Standard frame 68mm	add £175 (Pre-finished or white painted)
Coloured frame 68mm	add £232 (Coloured painted)
Cardale 650 operator	add £376
Cardale 800 operator	add £487
Glazing (Brompton)	add £496
Glazing (Georgian)	add £496
Painted door	add £93 (White) add £137 (Colours)

Colours available White, Ebony Black, Balmoral Green, Oxford Blue, Conker Brown, Monarch Red, Metallic Grey, Grey, Midnight Blue, Anthracite, Cherry & Burgundy









Optional extras for operators

Extra handsets	add £56 (2 channel) add £62 (4 channel)
Wireless key pad	add £155
External manual override	add £36
Keyswitch	add £39

Single door
Standard

Size mm (ft/in)	Width by Height														
		C	R	C	R	C	R	C	R	C	R				
1981 x 1981 (6'6" x 6'6")		-	-	-	-	712 753	-	-	512 553	-	-	572 614	712 753	624 665	
1981 x 2134 (6'6" x 7'0")		-	-	-	-	725 766	-	-	518 559	-	-	574 615	725 766	625 666	
2083 x 1905 (6'10" x 6'3")		-	-	-	-	-	-	-	525 567	-	-	586 627	-	-	638 678
2083 x 1930 (6'10" x 6'4")		-	-	-	-	691 732	-	-	528 570	-	-	579 621	691 732	638 678	
2083 x 1956 (6'10" x 6'5")		-	-	-	-	691 732	-	-	535 576	-	-	595 637	691 732	647 688	
2083 x 1981 (6'10" x 6'6")		-	-	-	-	691 732	-	-	542 583	-	-	595 637	691 732	647 688	
2108 x 1981 (6'11" x 6'6")		-	-	-	-	-	-	-	542 583	-	-	595 637	-	-	647 688
2108 x 2134 (6'11" x 7'0")		-	-	-	-	-	-	-	542 583	-	-	595 637	-	-	647 688
2134 x 1828 (7'0" x 6'0")		-	-	-	-	-	-	-	542 583	-	-	598 640	-	-	650 691
2134 x 1880 (7'0" x 6'2")		-	-	-	-	-	-	-	542 583	-	-	598 640	-	-	650 691
2134 x 1905 (7'0" x 6'3")		-	-	-	-	-	-	-	542 583	-	-	598 640	-	-	650 691
2134 x 1930 (7'0" x 6'4")		-	-	-	-	-	-	-	542 583	-	-	598 640	-	-	650 691
2134 x 1981 (7'0" x 6'6")		924 965	924 965	689 730	571 612	499 540	924 965	571 612	689 730	582 627					
2134 x 2134 (7'0" x 7'0")		929 970	929 970	724 765	585 626	534 577	929 970	585 626	724 765	642 683					
2210 x 1930 (7'3" x 6'4")		-	-	-	-	764 805	-	-	558 599	-	-	623 664	764 805	675 716	
2261 x 1981 (7'5" x 6'6")		-	-	-	-	788 829	-	-	573 614	-	-	634 676	788 829	657 698	
2261 x 2134 (7'5" x 7'0")		-	-	-	-	919 960	-	-	637 678	-	-	693 734	919 960	726 767	
2286 x 1828 (7'6" x 6'0")		-	-	-	-	-	-	-	561 603	-	-	618 659	-	-	669 711
2286 x 1905 (7'6" x 6'3")		-	-	-	-	-	-	-	561 603	-	-	618 659	-	-	669 711
2286 x 1981 (7'6" x 6'6")		956 997	956 997	769 811	617 658	560 602	955 997	617 658	769 811	657 698					
2286 x 2134 (7'6" x 7'0")		959 1000	959 1000	888 929	671 712	631 673	954 1000	671 712	888 929	726 767					
2438 x 1905 (8'0" x 6'3")		-	-	-	-	907 949	-	-	612 653	-	-	696 737	907 949	748 789	
2438 x 1930 (8'0" x 6'4")		-	-	-	-	907 949	-	-	637 678	-	-	715 756	907 949	766 808	
2438 x 1981 (8'0" x 6'6")		1009 1051	1009 1051	919 960	-	-	637 678	1009 1051	715 756	919 960	766 808				
2438 x 2134 (8'0" x 7'0")		1010 1052	1010 1052	919 960	-	-	648 689	1010 1052	743 784	919 960	794 835				

Single door
Made to measure

Width (up to) mm (ft/in)	Width by Height													
		C	R	C	R	C	R	C	R	C	R			
1981 (6'6")		-	-	-	-	828 869	-	-	621 662	-	-	677 718	828 869	728 769
2134 (7'0")		-	-	-	-	827 868	-	-	639 680	-	-	688 729	827 868	740 781
2286 (7'6")		-	-	-	-	991 1032	-	-	734 776	-	-	774 815	991 1032	825 866
2438 (8'0")		-	-	-	-	1067 1108	-	-	751 792	-	-	846 887	1067 1108	897 938

Size availability (mm)

	Bedford	Berkeley (Vertical)	Brompton	Chevron	Europa II	Gatcombe	Gemini	Georgian	Haven		
Minimum width	-	-	1930 1930	-	-	1829 1829	-	-	1829 1829	1930 1930	1829 1829
Maximum width	-	-	2438 2438	-	-	2438 2438	-	-	2438 2438	2438 2438	2438 2438
Minimum height	-	-	1930 1930	-	-	1829 1918	-	-	1829 1918	1930 1930	1905 1918
Maximum height	-	-	2134 2134	-	-	2134 2286	-	-	2134 2286	2134 2134	2134 2286

Please see page 10 for standard and made to measure single door options.

Single door
Standard

Size mm (ft/in) Width by Height	Jacobean		Olympian		Sheraton		Sheraton (Glazed)		Vogue	
	C	R	C	R	C	R	C	R	C	R
1981 x 1981 (6'6" x 6'6")	-	-	712	753	-	-	-	-	665	707
1981 x 2134 (6'6" x 7'0")	-	-	725	766	-	-	-	-	666	708
2083 x 1905 (6'10" x 6'3")	-	-	691	732	-	-	-	-	679	720
2083 x 1930 (6'10" x 6'4")	-	-	691	732	-	-	-	-	679	720
2083 x 1956 (6'10" x 6'5")	-	-	691	732	-	-	-	-	688	729
2083 x 1981 (6'10" x 6'6")	-	-	691	732	-	-	-	-	688	729
2108 x 1981 (6'11" x 6'6")	-	-	691	732	-	-	-	-	688	729
2108 x 2134 (6'11" x 7'0")	-	-	691	732	-	-	-	-	688	729
2134 x 1828 (7'0" x 6'0")	-	-	691	732	-	-	-	-	691	732
2134 x 1880 (7'0" x 6'2")	-	-	-	-	-	-	-	-	691	732
2134 x 1905 (7'0" x 6'3")	-	-	691	732	-	-	-	-	691	732
2134 x 1930 (7'0" x 6'4")	-	-	691	732	-	-	-	-	691	732
2134 x 1981 (7'0" x 6'6")	689	730	689	730	689	730	915	957	668	710
2134 x 2134 (7'0" x 7'0")	724	765	724	765	724	765	950	992	687	728
2210 x 1930 (7'3" x 6'4")	-	-	764	805	-	-	-	-	716	757
2261 x 1981 (7'5" x 6'6")	-	-	788	829	-	-	-	-	711	752
2261 x 2134 (7'5" x 7'0")	-	-	793	834	-	-	-	-	763	804
2286 x 1828 (7'6" x 6'0")	-	-	-	-	-	-	-	-	711	752
2286 x 1905 (7'6" x 6'3")	-	-	764	805	-	-	-	-	711	752
2286 x 1981 (7'6" x 6'6")	769	811	769	811	769	810	996	1037	763	804
2286 x 2134 (7'6" x 7'0")	888	929	888	929	888	929	1114	1156	763	804
2438 x 1905 (8'0" x 6'3")	-	-	919	960	-	-	-	-	789	830
2438 x 1930 (8'0" x 6'4")	-	-	907	949	-	-	-	-	808	849
2438 x 1981 (8'0" x 6'6")	907	949	907	949	907	948	1101	1175	808	849
2438 x 2134 (8'0" x 7'0")	964	1005	964	1005	964	1005	1156	1232	835	877

Single door
Made to measure

Width (up to) mm (ft/in) Width by Height	Jacobean		Olympian		Sheraton		Sheraton (Glazed)		Vogue	
	C	R	C	R	C	R	C	R	C	R
1981 (6'6")	-	-	828	869	-	-	-	-	769	811
2134 (7'0")	-	-	827	868	-	-	-	-	781	822
2286 (7'6")	991	1032	990	1032	991	1032	1217	1259	866	907
2438 (8'0")	1067	1108	1067	1108	1067	1108	1294	12335	938	980

Size availability (mm)

Minimum width	2185	2185	1829	1829	2185	2185	2185	2185	1829	1829
Maximum width	2438	2438	2438	2438	2438	2438	2438	2438	2438	2438
Minimum height	1981*	1981*	1905	1918	1981*	1981*	1981*	1981*	1829	1918
Maximum height	2134*	2134*	2134	2286	2134*	2134*	2134*	2134*	2134	2286

C = Canopy gear, R = Retractable gear.

Plastisol up and over single doors - options

Brass effect handle	add £46
Draught strip	add £31
Painted frame 54mm/68mm	add £98 (Pre-finished or white painted)
Coloured frame 54mm/68mm	add £134 (Coloured painted)
Plastisol frame 54mm/68mm	add £144
Cardale 650 operator	add £376
Canopy converter	add £98
Cardale 800 operator	add £487
Glazing (Bedford)	add £118 (Stippled) Black mock glazing standard
Glazing (Brompton)	add £248
Glazing (Georgian)	add £248
Glazing (Sheraton)	Plain black, Stippled, Transparent, Diamond lattice, Queen Anne lattice, Square lattice (Sheraton only at no extra cost)

Optional extras for operators

Extra handsets	add £56 (2 channel) add £62 (4 channel)
Wireless key pad	add £155
External manual override	add £36
Keyswitch	add £39

* Choice of 54mm or 68mm optional frame for canopy doors.
68mm optional frame only for retractable doors.

Please see pages 33 & 34 for side hinged doors & options

Double door
White Plastisol

Size mm (ft/in) Width by Height	Bedford	Brompton	Chevron	Europa II	Gemini	Georgian
	R	R	R	R	R	R
2743 x 1981 (9'0" x 6'6")	-	1154	-	995	989	1154
2743 x 2134 (9'0" x 7'0")	-	1174	-	1020	1015	1174
2896 x 1981 (9'6" x 6'6")	-	1038	-	1108	1117	1038
2896 x 2134 (9'6" x 7'0")	-	1059	-	1134	1142	1059
3048 x 1981 (10'0" x 6'6")	-	1307	-	1222	1162	1307
3048 x 2134 (10'0" x 7'0")	-	1332	-	1247	1188	1332
3200 x 1981 (10'6" x 6'6")	-	1364	-	1288	1237	1364
3200 x 2134 (10'6" x 7'0")	-	1384	-	1313	1252	1384
3353 x 1981 (11'0" x 6'6")	-	1405	-	1354	1263	1405
3353 x 2134 (11'0" x 7'0")	-	1426	-	1380	1278	1426
3505 x 1981 (11'6" x 6'6")	-	1446	-	1413	1299	1446
3505 x 2134 (11'6" x 7'0")	-	1467	-	1439	1314	1467
3658 x 1981 (12'0" x 6'6")	-	1507	-	1472	1330	1507
3658 x 2134 (12'0" x 7'0")	-	1528	-	1498	1345	1528
3810 x 1981 (12'6" x 6'6")	-	1549	-	1515	1361	1549
3810 x 2134 (12'6" x 7'0")	-	1569	-	1541	1376	1569
3962 x 1981 (13'0" x 6'6")	-	1669	-	1558	1392	1669
3962 x 2134 (13'0" x 7'0")	-	1709	-	1584	1407	1709
4115 x 1981 (13'6" x 6'6")	-	1669	-	1605	1422	1669
4115 x 2134 (13'6" x 7'0")	-	1689	-	1630	1438	1689
4267 x 1981 (14'0" x 6'6")	2130	1679	1494	1475	1246	1679
4267 x 2134 (14'0" x 7'0")	2156	1679	1475	1501	1272	1679
4420 x 1981 (14'6" x 6'6")	-	1699	-	1651	1464	1699
4420 x 2134 (14'6" x 7'0")	-	1719	-	1677	1479	1719
4572 x 1981 (15'0" x 6'6")	-	1749	-	1801	1495	1749
4572 x 2134 (15'0" x 7'0")	-	1770	-	1827	1510	1770
4877 x 1981 (16'0" x 6'6")	-	2000	-	1826	1525	2000
4877 x 2134 (16'0" x 7'0")	-	2020	-	1852	1541	2020

R = Retractable gear.

Plastisol up and over double doors - options

Brass effect handle	add £46
Draught strip	add £61
Painted frame 68mm	add £175 (Pre-finished or white painted)
Coloured frame 68mm	add £211 (Coloured painted)
Plastisol frame 68mm	add £232
Cardale 650 operator	add £376
Cardale 800 operator	add £487

Glazing (Bedford)	add £236 (Stippled) Black mock glazing standard
Glazing (Brompton)	add £496
Glazing (Georgian)	add £496
Glazing (Sheraton)	Plain black, Stippled, Transparent, Diamond lattice, Queen Anne lattice, Square lattice (Sheraton only at no extra cost)

* 1854 (6'1") on doors over 2438 (8'0") wide

* 1981 and 2134 heights only on Sheraton and Jacobean

Double door
White Plastisol

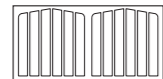

Jacobean



Olympian

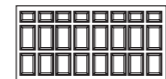

Sheraton

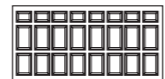

Sheraton (Glazed)

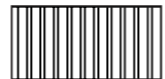

Vogue

Size mm (ft/in)	Jacobean	Olympian	Sheraton	Sheraton (Glazed)	Vogue
Width by Height	R	R	R	R	R
2743 x 1981 (9'0" x 6'6")	-	1256	1154	1576	1174
2743 x 2134 (9'0" x 7'0")	-	1281	1174	1596	1200
2896 x 1981 (9'6" x 6'6")	-	1374	1038	1460	1220
2896 x 2134 (9'6" x 7'0")	-	1400	1059	1481	1245
3048 x 1981 (10'0" x 6'6")	-	1492	1307	1729	1265
3048 x 2134 (10'0" x 7'0")	-	1518	1332	1754	1291
3200 x 1981 (10'6" x 6'6")	-	1547	1364	1786	1413
3200 x 2134 (10'6" x 7'0")	-	1573	1384	1806	1439
3353 x 1981 (11'0" x 6'6")	-	1603	1405	1827	1563
3353 x 2134 (11'0" x 7'0")	-	1628	1426	1848	1588
3505 x 1981 (11'6" x 6'6")	-	1670	1446	1868	1599
3505 x 2134 (11'6" x 7'0")	-	1695	1467	1889	1624
3658 x 1981 (12'0" x 6'6")	-	1738	1507	1929	1636
3658 x 2134 (12'0" x 7'0")	-	1763	1528	1950	1661
3810 x 1981 (12'6" x 6'6")	-	1828	1549	1971	1682
3810 x 2134 (12'6" x 7'0")	-	1854	1569	1991	1708
3962 x 1981 (13'0" x 6'6")	-	1919	1669	2091	1729
3962 x 2134 (13'0" x 7'0")	-	1945	1709	2131	1755
4115 x 1981 (13'6" x 6'6")	-	2049	1669	2091	1824
4115 x 2134 (13'6" x 7'0")	-	2074	1689	2111	1850
4267 x 1981 (14'0" x 6'6")	1884	1884	1679	2101	1597
4267 x 2134 (14'0" x 7'0")	1910	1910	1679	2101	1622
4420 x 1981 (14'6" x 6'6")	-	2153	1699	2121	1920
4420 x 2134 (14'6" x 7'0")	-	2178	1719	2141	1946
4572 x 1981 (15'0" x 6'6")	-	2257	1749	2171	1960
4572 x 2134 (15'0" x 7'0")	-	2282	1770	2192	1986
4877 x 1981 (16'0" x 6'6")	-	2383	2000	2422	2152
4877 x 2134 (16'0" x 7'0")	-	2409	2020	2442	2177

Please see page 11 for standard double door options.

Optional extras for operators

Extra handsets	add £56 (2 channel) add £62 (4 channel)
Wireless key pad	add £155
External manual override	add £36
Keyswitch	add £39

Double door
White Plastisol

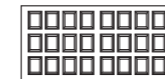

Brompton



Europa II

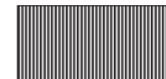

Gemini

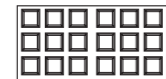

Georgian



Olympian



Vogue

Width (up to) mm (ft/in)	Brompton	Europa II	Gemini	Georgian	Olympian	Vogue
Width by Height	R	R	R	R	R	R
2591 (8'6")	1216	1201	1195	1216	1462	1380
2743 (9'0")	1216	1201	1195	1216	1462	1380
2896 (9'6")	1278	1314	1348	1278	-	1426
3048 (10'0")	1534	1428	1394	1534	1699	1471
3200 (10'6")	1604	1494	1458	1604	-	1619
3353 (11'0")	1645	1560	1484	1645	1809	1769
3505 (11'6")	1686	1619	1520	1686	-	1805
3658 (12'0")	1727	1678	1551	1727	1944	1842
3810 (12'6")	1769	1721	1582	1769	-	1888
3962 (13'0")	1786	1764	1613	1786	2125	1935
4267 (14'0")	1818	1681	1478	1818	2090	1803
4572 (15'0")	1852	-	1716	1852	2463	2166
4877 (16'0")	1907	-	1747	1907	2589	2358

Size availability (mm)

Minimum width	1930	1829	1829	1930	1829	1829
Maximum width	4877	4267	4877	4877	4877	4877
Minimum height	1930*	1918*	1918*	1930*	1918	1918*
Maximum height	2134	2286	2286	2134	2286	2286

* 1854 (6'1") on doors over 2438 (8'0") wide

Prices applicable to all available heights.

R = Retractable gear.

Plastisol up and over double doors - options

Brass effect handle	add £46
Draught strip	add £61
Painted frame 68mm	add £175 (Pre-finished or white painted)
Coloured frame 68mm	add £211 (Coloured painted)
Plastisol frame 68mm	add £232
Cardale 650 operator	add £376
Cardale 800 operator	add £487
Glazing (Brompton)	add £496
Glazing (Georgian)	add £496

Optional extras for operators

Extra handsets	add £56 (2 channel) add £62 (4 channel)
Wireless key pad	add £155
External manual override	add £36
Keyswitch	add £39

Single door

Standard

Size mm (ft/in)
Width by Height

	Bedford		Berkeley (Vertical)		Brompton		Europa II		Gatcombe		Gemini		Georgian		Haven		Jacobean	
	C	R	C	R	C	R	C	R	C	R	C	R	C	R	C	R	C	R
1981 x 1981 (6'6" x 6'6")	-	-	-	-	774	815	574	615	-	-	634	676	774	815	686	727	-	-
1981 x 2134 (6'6" x 7'0")	-	-	-	-	787	828	580	621	-	-	635	677	787	828	687	728	-	-
2083 x 1905 (6'10" x 6'3")	-	-	-	-	-	-	587	628	-	-	648	689	-	-	699	741	-	-
2083 x 1930 (6'10" x 6'4")	-	-	-	-	753	795	590	631	-	-	642	683	753	795	699	741	-	-
2083 x 1956 (6'10" x 6'5")	-	-	-	-	753	795	596	638	-	-	657	698	753	795	709	750	-	-
2083 x 1981 (6'10" x 6'6")	-	-	-	-	753	795	604	645	-	-	657	698	753	795	709	750	-	-
2108 x 1981 (6'11" x 6'6")	-	-	-	-	753	795	604	645	-	-	657	698	753	795	709	750	-	-
2108 x 2134 (6'11" x 7'0")	-	-	-	-	753	795	604	645	-	-	657	698	753	795	709	750	-	-
2134 x 1828 (7'0" x 6'0")	-	-	-	-	-	-	604	645	-	-	660	701	-	-	712	753	-	-
2134 x 1880 (7'0" x 6'2")	-	-	-	-	-	-	604	645	-	-	660	701	-	-	712	753	-	-
2134 x 1905 (7'0" x 6'3")	-	-	-	-	-	-	604	645	-	-	660	701	-	-	712	753	-	-
2134 x 1930 (7'0" x 6'4")	-	-	-	-	-	-	604	645	-	-	660	701	-	-	712	753	-	-
2134 x 1981 (7'0" x 6'6")	986	1027	986	1027	751	792	560	602	986	1027	632	674	751	792	644	685	751	792
2134 x 2134 (7'0" x 7'0")	991	1032	991	1032	786	827	597	639	991	1032	647	688	786	827	704	729	786	827
2210 x 1930 (7'3" x 6'4")	-	-	-	-	826	867	620	661	-	-	685	726	826	867	736	778	-	-
2261 x 1981 (7'5" x 6'6")	-	-	-	-	850	891	634	676	-	-	696	737	850	891	718	760	-	-
2261 x 2134 (7'5" x 7'0")	-	-	-	-	981	1022	698	740	-	-	755	796	981	1022	793	834	-	-
2286 x 1828 (7'6" x 6'0")	-	-	-	-	-	-	623	664	-	-	680	721	-	-	731	773	-	-
2286 x 1905 (7'6" x 6'3")	-	-	-	-	-	-	623	664	-	-	680	721	-	-	731	773	-	-
2286 x 1981 (7'6" x 6'6")	1017	1059	1017	1059	831	872	622	663	1018	1059	679	720	831	872	719	760	831	872
2286 x 2134 (7'6" x 7'0")	1021	1062	1021	1062	950	991	693	734	1021	1062	732	774	950	991	789	829	950	991
2438 x 1905 (8'0" x 6'3")	-	-	-	-	969	981	674	715	-	-	758	799	969	981	810	851	-	-
2438 x 1930 (8'0" x 6'4")	-	-	-	-	969	981	698	740	-	-	777	818	969	981	828	869	-	-
2438 x 1981 (8'0" x 6'6")	1071	1112	1071	1112	981	1022	698	740	1071	1112	777	818	981	1022	828	869	969	1010
2438 x 2134 (8'0" x 7'0")	1072	1113	1072	1113	981	1022	689	751	1072	1113	804	846	981	1022	856	897	1026	1067

Single door

Made to measure

Width (up to) mm (ft/in)
Width by Height

	Bedford		Berkeley (Vertical)		Brompton		Europa II		Gatcombe		Gemini		Georgian		Haven		Jacobean	
	C	R	C	R	C	R	C	R	C	R	C	R	C	R	C	R	C	R
1981 (6'6")	-	-	-	-	890	931	683	724	-	-	739	780	890	931	790	831	-	-
2134 (7'0")	-	-	-	-	889	930	700	742	-	-	750	791	889	930	801	843	-	-
2286 (7'6")	-	-	-	-	1053	1114	796	837	-	-	835	877	1053	1114	887	928	1053	1114
2438 (8'0")	-	-	-	-	1129	1170	813	854	-	-	907	949	1129	1170	959	1000	1129	1170

Size availability (mm)

Minimum width	-	-	-	-	1930	1930	1829	1829	-	-	1829	1829	1930	1930	1829	1829	2185	2185
Maximum width	-	-	-	-	2438	2438	2438	2438	-	-	2438	2438	2438	2438	2438	2438	2438	2438
Minimum height	-	-	-	-	1930	1930	1829	1918*	-	-	1829	1918*	1930	1930	1905	1918	1981*	1981*
Maximum height	-	-	-	-	2134	2134	2134	2286	-	-	2134	2286	2134	2134	2134	2286	2134*	2134*

Single door

Standard

Size mm (ft/in)
Width by Height

	Orion (Horizontal)		Orion (Vertical)		Sheraton		Sheraton (Glazed)		Vogue			
	C	R	C	R	C	R	C	R	C	R		
1981 x 1981 (6'6" x 6'6")	774	815	774	815	-	-	-	-	727	768		
1981 x 2134 (6'6" x 7'0")	787	828	787	828	-	-	-	-	728	769		
2083 x 1905 (6'10" x 6'3")	-	-	-	-	-	-	-	-	741	782		
2083 x 1930 (6'10" x 6'4")	753	795	753	795	-	-	-	-	741	782		
2083 x 1956 (6'10" x 6'5")	753	795	753	795	-	-	-	-	750	791		
2083 x 1981 (6'10" x 6'6")	753	795	753	795	-	-	-	-	750	791		
2108 x 1981 (6'11" x 6'6")	753	795	753	795	-	-	-	-	750	791		
2108 x 2134 (6'11" x 7'0")	753	795	753	795	-	-	-	-	750	791		
2134 x 1828 (7'0" x 6'0")	-	-	-	-	-	-	-	-	753	794		
2134 x 1880 (7'0" x 6'2")	-	-	-	-	-	-	-	-	753	794		
2134 x 1905 (7'0" x 6'3")	-	-	-	-	-	-	-	-	753	794		
2134 x 1930 (7'0" x 6'4")	-	-	-	-	-	-	-	-	753	794		
2134 x 1981 (7'0" x 6'6")	751	792	751	792	751	792	751	792	977	1019	730	771
2134 x 2134 (7'0" x 7'0")	786	827	786	827	786	827	786	827	1012	1054	749	790
2210 x 1930 (7'3" x 6'4")	826	867	826	867	-	-	-	-	778	819		
2261 x 1981 (7'5" x 6'6")	850	891	850	891	-	-	-	-	773	814		
2261 x 2134 (7'5" x 7'0")	981	1022	981	1022	-	-	-	-	825	866		
2286 x 1828 (7'6" x 6'0")	-	-	-	-	-	-	-	-	773	814		
2286 x 1905 (7'6" x 6'3")	-	-	-	-	-	-	-	-	773	814		
2286 x 1981 (7'6" x 6'6")	831	872	831	872	831	872	1058	1099	825	866		
2286 x 2134 (7'6" x 7'0")	950	991	950	991	950	991	1176	1217	825	866		
2438 x 1905 (8'0" x 6'3")	969	981	969	981	-	-	-	-	851	892		
2438 x 1930 (8'0" x 6'4")	969	981	969	981	-	-	-	-	869	911		
2438 x 1981 (8'0" x 6'6")	981	1022	981	1022	969	1010	1196	1237	869	911		
2438 x 2134 (8'0" x 7'0")	981	1022	981	1022	1026	1067	1252	1294	897	938		

Single door

Made to measure

Width (up to) mm (ft/in)
Width by Height

	Orion (Horizontal)		Orion (Vertical)		Sheraton		Sheraton (Glazed)		Vogue	
	C	R	C	R	C	R	C	R	C	R
1981 (6'6")	890	931	890	931	-	-	-	-	831	866
2134 (7'0")	889	930	889	930	-	-	-	-	843	884
2286 (7'6")	1053	1114	1053	1114	1053	1114	1279	1320	928	969
2438 (8'0")	1129	1170	1129	1170	1129	1170	1355	1397	1000	1041

Size availability (mm)

Minimum width	1829	1829	1829	1829	2185	2185	2185	2185	1829	1829
Maximum width	2438	2438	2438	2438	2438	2438	2438	2438	2438	2438
Minimum height	1829	1918*	1829	1918*	1981*	1981*	1981*	1981*	1829	1918
Maximum height	2134	2286	2134	2286	2134*	2134*	2134*	2134*	2134	2286

C = Canopy gear, R = Retractable gear.

Golden Oak & Rosewood up and over single doors - options

Brass effect handle	add £46
Flush lock handle	add £36 (Gemini and Europa only)
Draught strip	add £31
Standard frame 54mm/68mm	add £98 (Pre-finished or white painted)
Coloured frame 54mm/68mm	add £134 (Coloured painted)
Golden Oak & Rosewood frame 54mm/68mm	add £201 (Golden Oak & Rosewood)
Cardale 650 operator	add £376
Canopy converter	add £98
Cardale 800 operator	add £487
Glazing (Bedford)	add £118 (Stippled) Black mock glazing standard
Glazing (Brompton)	add £248
Glazing (Georgian)	add £248
Glazing (Sheraton)	Plain black, Stippled, Transparent, Diamond lattice, Queen Anne lattice, Square lattice (Sheraton only at no extra cost)



Optional extras for operators

Extra handsets	add £56 (2 channel) add £62 (4 channel)
Wireless key pad	add £155
External manual override	add £36
Keyswitch	add £39

* Choice of 54mm or 68mm optional frame for canopy doors.
68mm optional frame only for retractable doors.

Please see page 32 for side hinged doors & options

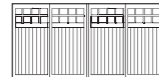
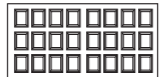
Double door

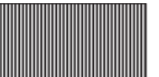
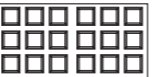
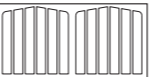
Size mm (ft/in) Width by Height						
	Bedford R	Brompton R	Europa II R	Gemini R	Georgian R	Jacobean R
2743 x 1981 (9'0" x 6'6")	-	1124	1108	1102	1124	-
2743 x 2134 (9'0" x 7'0")	-	1144	1134	1128	1144	-
2896 x 1981 (9'6" x 6'6")	-	1165	1222	1230	1165	-
2896 x 2134 (9'6" x 7'0")	-	1186	1247	1256	1186	-
3048 x 1981 (10'0" x 6'6")	-	1415	1335	1275	1415	-
3048 x 2134 (10'0" x 7'0")	-	1441	1361	1301	1441	-
3200 x 1981 (10'6" x 6'6")	-	1490	1402	1350	1490	-
3200 x 2134 (10'6" x 7'0")	-	1511	1427	1366	1511	-
3353 x 1981 (11'0" x 6'6")	-	1531	1468	1376	1531	-
3353 x 2134 (11'0" x 7'0")	-	1552	1494	1392	1552	-
3505 x 1981 (11'6" x 6'6")	-	1573	1526	1412	1573	-
3505 x 2134 (11'6" x 7'0")	-	1593	1552	1428	1593	-
3658 x 1981 (12'0" x 6'6")	-	1614	1585	1443	1614	-
3658 x 2134 (12'0" x 7'0")	-	1635	1611	1458	1635	-
3810 x 1981 (12'6" x 6'6")	-	1655	1628	1474	1655	-
3810 x 2134 (12'6" x 7'0")	-	1676	1654	1489	1676	-
3962 x 1981 (13'0" x 6'6")	-	1685	1672	1505	1685	-
3962 x 2134 (13'0" x 7'0")	-	1693	1697	1520	1693	-
4115 x 1981 (13'6" x 6'6")	-	1702	1775	1536	1702	-
4115 x 2134 (13'6" x 7'0")	-	1710	1800	1551	1710	-
4267 x 1981 (14'0" x 6'6")	2243	1700	1588	1360	1700	1997
4267 x 2134 (14'0" x 7'0")	2243	1725	1614	1385	1725	2023
4420 x 1981 (14'6" x 6'6")	-	1718	1951	1577	1718	-
4420 x 2134 (14'6" x 7'0")	-	1733	1977	1592	1733	-
4572 x 1981 (15'0" x 6'6")	-	1744	-	1608	1744	-
4572 x 2134 (15'0" x 7'0")	-	1759	-	1623	1759	-
4877 x 1981 (16'0" x 6'6")	-	1798	-	1639	1798	-
4877 x 2134 (16'0" x 7'0")	-	1814	-	1654	1814	-



R = Retractable gear.

Golden Oak & Rosewood up and over double doors - options

Brass effect handle	add £46
Draught strip	add £61
Standard frame 68mm	add £175 (Pre-finished or white painted)
Coloured frame 68mm	add £211 (Coloured painted)
Golden Oak & Rosewood frame 68mm	add £304 (Golden Oak & Rosewood)
Cardale 650 operator	add £376
Cardale 800 operator	add £487

Glazing (Bedford)	add £236 (Stippled)
	Black mock glazing standard
Glazing (Brompton)	add £496 (Stippled & Plain?)
Glazing (Georgian)	add £496 (Stippled & Plain?)
Glazing (Sheraton)	Plain black, Stippled, Transparent, Diamond lattice, Queen Anne lattice, Square lattice (Sheraton only at no extra cost)

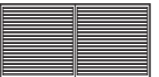
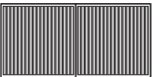
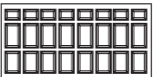
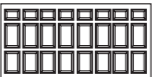

Double door

Size mm (ft/in) Width by Height					
	Orion (Horizontal) R	Orion (Vertical) R	Sheraton R	Sheraton (Glazed) R	Vogue R
2743 x 1981 (9'0" x 6'6")	-	-	-	-	1294
2743 x 2134 (9'0" x 7'0")	-	-	-	-	1313
2896 x 1981 (9'6" x 6'6")	-	-	-	-	1333
2896 x 2134 (9'6" x 7'0")	-	-	-	-	1359
3048 x 1981 (10'0" x 6'6")	-	-	-	-	1378
3048 x 2134 (10'0" x 7'0")	-	-	-	-	1404
3200 x 1981 (10'6" x 6'6")	-	-	1912	1526	-
3200 x 2134 (10'6" x 7'0")	-	-	1511	1933	1552
3353 x 1981 (11'0" x 6'6")	-	-	-	-	1676
3353 x 2134 (11'0" x 7'0")	-	-	-	-	1702
3505 x 1981 (11'6" x 6'6")	-	-	-	-	1712
3505 x 2134 (11'6" x 7'0")	-	-	-	-	1717
3658 x 1981 (12'0" x 6'6")	-	-	-	-	1749
3658 x 2134 (12'0" x 7'0")	-	-	-	-	1775
3810 x 1981 (12'6" x 6'6")	-	-	-	-	1795
3810 x 2134 (12'6" x 7'0")	-	-	-	-	1821
3962 x 1981 (13'0" x 6'6")	-	-	-	-	1843
3962 x 2134 (13'0" x 7'0")	-	-	-	-	1868
4115 x 1981 (13'6" x 6'6")	-	-	-	-	1937
4115 x 2134 (13'6" x 7'0")	-	-	-	-	1963
4267 x 1981 (14'0" x 6'6")	2243	2243	1997	2419	1710
4267 x 2134 (14'0" x 7'0")	2243	2243	2023	2445	1736
4420 x 1981 (14'6" x 6'6")	-	-	-	-	2033
4420 x 2134 (14'6" x 7'0")	-	-	-	-	2058
4572 x 1981 (15'0" x 6'6")	-	-	-	-	2073
4572 x 2134 (15'0" x 7'0")	-	-	-	-	2099
4877 x 1981 (16'0" x 6'6")	-	-	-	-	2265
4877 x 2134 (16'0" x 7'0")	-	-	-	-	2291

Optional extras for operators

Extra handsets	add £56 (2 channel)
	add £62 (4 channel)
Wireless key pad	add £155
External manual override	add £36
Keypad	add £39

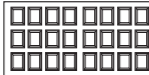
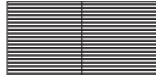
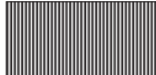
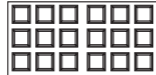
Double door

Width (up to) mm (ft/in)	Width by Height					
		Bedford	Brompton	Europa II	Gemini	Vogue
		R	R	R	R	R
2591 (8'6")		1330	1314	1308	1330	1494
2743 (9'0")		1330	1314	1308	1330	1494
2896 (9'6")		1392	1428	1462	1392	1539
3048 (10'0")		1647	1541	1507	1647	1584
3200 (10'6")		1717	1607	1572	1717	1732
3353 (11'0")		1758	1674	1598	1758	1882
3505 (11'6")		1799	1732	1634	1799	1918
3658 (12'0")		1841	1791	1664	1841	1955
3810 (12'6")		1882	1834	1695	1882	2001
3962 (13'0")		1899	1878	1726	1899	2049
4267 (14'0")		1931	1794	1591	1931	1916
4572 (15'0")		1965	-	1829	1965	2279
4877 (16'0")		2020	-	1860	2020	2471

Size availability (mm)

	Bedford	Brompton	Europa II	Gemini	Vogue
Minimum width	1930	1829	1829	1930	1829
Maximum width	4877	4267	4877	4877	4877
Minimum height	1854	1854	1854	1854	1854
Maximum height	2184	2286	2286	2184	2286

Prices applicable to all available heights.

R = Retractable gear.









Golden Oak & Rosewood up and over double doors - options

Brass effect handle	add £46
Draught strip	add £61
Standard frame 68mm	add £175 (Pre-finished or white painted)
Coloured frame 68mm	add £211 (Coloured painted)
Golden Oak & Rosewood frame 68mm	add £304 (Golden Oak & Rosewood)
Cardale 650 operator	add £376
Cardale 800 operator	add £487
Glazing (Brompton)	add £496
Glazing (Georgian)	add £496





Optional extras for operators

Extra handsets	add £56 (2 channel) add £62 (4 channel)
Wireless key pad	add £155
External manual override	add £36
Keyswitch	add £39

Single door (Standard)

Size mm (ft/in)	Width by Height																
		Bedford	Berkeley (Horizontal)	Berkeley (Vertical)	Horizontal	Jacobean	President	Regal	Senator								
		C	R	C	R	C	R	C	R	C	R						
2134 x 1981 (7'0" x 6'6")		956	997	828	869	828	869	642	683	870	912	956	997	828	869	870	912
2134 x 2134 (7'0" x 7'0")		956	997	828	869	828	869	642	683	870	912	956	997	828	869	870	912
2286 x 1981 (7'6" x 6'6")		1043	1085	916	957	916	957	717	758	956	997	1043	1085	916	957	956	997
2286 x 2134 (7'6" x 7'0")		1043	1085	916	957	916	957	717	758	956	997	1043	1085	916	957	956	997
2438 x 1981 (8'0" x 6'6")		1129	1170	1003	1044	1003	1044	794	835	1043	1085	1129	1170	1003	1044	1043	1085
2438 x 2134 (8'0" x 7'0")		1129	1170	1003	1044	1003	1044	784	835	1043	1085	1129	1170	1003	1044	1043	1085

Single door (Standard)

Size mm (ft/in)	Width by Height										
		Tudor	Vertical	Vertical (Golden Oak)	Vertical (Rosewood)	Victoriana					
		C	R	C	R						
2134 x 1981 (7'0" x 6'6")		870	912	642	683	828	869	828	869	881	922
2134 x 2134 (7'0" x 7'0")		870	912	642	683	828	869	828	869	881	922
2286 x 1981 (7'6" x 6'6")		956	997	717	758	916	957	916	957	966	1007
2286 x 2134 (7'6" x 7'0")		956	997	717	758	916	957	916	957	966	1007
2438 x 1981 (8'0" x 6'6")		1043	1085	794	835	1003	1044	1003	1044	1054	1095
2438 x 2134 (8'0" x 7'0")		1043	1085	794	835	1003	1044	1003	1044	1054	1095

C = Canopy gear, R = Retractable gear.

ABS up and over single doors - options

Brass effect handle	add £46
Draught strip	add £31
frame 54mm/68mm	add £98 (Pre-finished or white painted)
Coloured frame 54mm/68mm	add £134 (Coloured painted)
Cardale 650 operator	add £376
Canopy converter	add £98
Cardale 800 operator	add £487
Glazing (Bedford)	add £118 (Stippled) Black mock glazing standard
Glazing (President)	add £248 (Stippled & Plain) Black mock glazing standard
Glazing (Senator)	Plain black, Stippled, Transparent, Diamond lattice, Queen Anne lattice, Square lattice (add £227)

Now available insulated with a smooth interior finish on request (unglazed doors only, add 50% to non insulated door price.

Please see page 35 for side hinged doors & options

Optional extras for operators

Extra handsets	add £56 (2 channel) add £62 (4 channel)
Wireless key pad	add £155
External manual override	add £36
Keyswitch	add £39

Single door

(Made to measure)

Width (up to) mm (ft/in)	Bedford		Berkeley (Horizontal)		Berkeley (Vertical)		Horizontal		Jacobean		President		Regal		Senator	
	C	R	C	R	C	R	C	R	C	R	C	R	C	R	C	R
1981 (6'6")	1083	1125	956	997	956	997	757	798	1000	1041	1083	1125	956	997	1000	1041
2134 (7'0")	1083	1125	956	997	956	997	757	798	1000	1041	1083	1125	956	997	1000	1041
2286 (7'6")	1170	1211	1043	1085	1043	1085	834	876	1083	1124	1170	1211	1043	1085	1083	1124
2438 (8'0")	1258	1299	1129	1170	1129	1170	908	950	1170	1211	1258	1299	1129	1170	1136	1211

Size availability (mm)

		3 Panel			4 Panel			
Minimum width	2032	1981	1981	1981	1991	1959	1911	2016
Maximum width	2530	2530	2530	2153	2524	2572	2572	2572
Minimum height	1873	1845	1845	1838	1895	1930	1918	1829
Maximum height	2235	2235	2235	2235	2223	2261	2261	2261
Minimum width	-	-	-	2197	-	-	-	-
Maximum width	-	-	-	2530	-	-	-	-
Minimum height	-	-	-	1845	-	-	-	-
Maximum height	-	-	-	2235	-	-	-	-

Single door

(Made to measure)

Width (up to) mm (ft/in)	Tudor		Vertical		NEW Vertical (Golden Oak)		NEW Vertical (Rosewood)		Victoriana	
	C	R	C	R	C	R	C	R	C	R
1981 (6'6")	1000	1041	757	798	956	997	956	997	1010	1052
2134 (7'0")	1000	1041	757	798	956	997	956	997	1010	1052
2286 (7'6")	1083	1124	834	876	1043	1085	1043	1085	1094	1135
2438 (8'0")	1170	1211	908	950	1129	1170	1129	1170	1180	1222

Size availability (mm)

Minimum width	1991	1981	1981	1981	1965
Maximum width	2530	2153	2743	2743	2572
Minimum height	1905	1845	1838	1838	1857
Maximum height	2210	2235	2286	2286	2261
Minimum width	-	2197	-	-	-
Maximum width	-	2530	-	-	-
Minimum height	-	1845	-	-	-
Maximum height	-	2235	-	-	-

Please see page 35 for side hinged doors & options

C = Canopy gear, R = Retractable gear.

ABS up and over single doors - options

Brass effect handle	add £46
Draught strip	add £31
frame 54mm/68mm	add £98 (Pre-finished or white painted)
Coloured frame 54mm/68mm	add £134 (Coloured painted)
Cardale 650 operator	add £376
Canopy converter	add £98
Cardale 800 operator	add £487
Glazing (Bedford)	add £118 (Stippled) Black mock glazing standard
Glazing (President)	add £248 (Stippled & Plain) Black mock glazing standard
Glazing (Senator)	Plain black, Stippled, Transparent, Diamond lattice, Queen Anne lattice, Square lattice (add £227)

Now available insulated with a smooth interior finish on request (unglazed doors only, add 50% to non insulated door price.

Optional extras for operators

Extra handsets	add £56 (2 channel) add £62 (4 channel)
Wireless key pad	add £155
External manual override	add £36
Keyswitch	add £39

Double door

(Standard)

Size mm (ft/in)	President		Regal		Senator	
	C	R	C	R	C	R
4267 x 1981 (14'0" x 6'6")		2153		1940		2025
4267 x 2134 (14'0" x 7'0")		2153		1940		2025

Double door

(Made to measure)

Width (up to) mm (ft/in)	President		Regal		Senator	
	C	R	C	R	C	R
2591 (8'6")		1482		1288		1331
2743 (9'0")		-		1288		1331
3048 (10'0")		-		1454		1504
3353 (11'0")		-		1616		1698
3658 (12'0")		2153		1711		1863
3962 (13'0")		2305		1781		-
4267 (14'0")		2354		2100		2158
4572 (15'0")		2543		2428		2510

Size availability (mm)

		4 Panel	5 Panel
Minimum width	3956	2565	2524
Maximum width	4515	2791	2645
Minimum height	1930	1918	1829
Maximum height	2261	2261	2261
Minimum width	-	5 Panel	6 Panel
Maximum width	-	3448	3156
Minimum height	-	1918	1829
Maximum height	-	2261	2261
Minimum width	-	6 Panel	7 Panel
Maximum width	-	3883	3540
Minimum height	-	4515	3664
Maximum height	-	1918	1829
Minimum width	-	2261	2261
Maximum width	-	-	8 Panel
Minimum height	-	-	4048
Maximum height	-	-	4515
Minimum height	-	-	1829
Maximum height	-	-	2261

ABS up and over Double doors - options

Brass effect handle	add £46
Draught strip	add £61
Frame 54mm/68mm	add £175 (Pre-finished or white painted)
Coloured frame 54mm/68mm	add £211 (Coloured painted)
Cardale 650 operator	add £376
Cardale 800 operator	add £487
Glazing (President)	add £486 (Stippled or Plain) Black mock glazing standard
Glazing (Senator)	Plain black, Stippled, Transparent, Diamond lattice, Queen Anne lattice, Square lattice (add £422)

Single door (Standard)

Size mm (ft/in) Width by Height	Bedford		Berkeley (Vertical)		Burley		Chevron		Cotswold		Gatcombe		Hampshire		Horizontal	
	C	R	C	R	C	R	C	R	C	R	C	R	C	R	C	R
2134 x 1981 (7'0" x 6'6")	1505	1525	1338	1358	1307	1327	1379	1399	1398	1418	1279	1299	1585	1605	1188	1229
2134 x 2134 (7'0" x 7'0")	1530	1550	1345	1365	1310	1330	1432	1452	1405	1425	1285	1305	1657	1677	1188	1229
2134 x 2286 (7'0" x 7'6")	-	1599	-	1432	-	1430	-	1730	-	1492	-	-	-	1955	-	1299
2134 x 2438 (7'0" x 8'0")	-	1651	-	1598	-	1558	-	1821	-	1658	-	-	-	2042	-	1390
2286 x 1981 (7'6" x 6'6")	1600	1620	1379	1399	1341	1361	1450	1470	1439	1459	1379	1399	1775	1795	1225	1265
2286 x 2134 (7'6" x 7'0")	1612	1632	1390	1410	1369	1389	1512	1532	1480	1500	1390	1410	1783	1803	1265	1287
2286 x 2286 (7'6" x 7'6")	-	1665	-	1489	-	1506	-	1799	-	1601	-	1489	-	2129	-	1336
2286 x 2438 (7'6" x 8'0")	-	1702	-	1650	-	1632	-	1960	-	1705	-	1632	-	2281	-	1559
2438 x 1981 (8'0" x 6'6")	1607	1627	1438	1458	1378	1398	1623	1643	1516	1536	1438	1458	1842	1862	1307	1311
2438 x 2134 (8'0" x 7'0")	1640	1660	1440	1460	1409	1429	1674	1694	1540	1560	1440	1460	1891	1911	1332	1320

Single door (Made to measure)

Width (up to) mm (ft/in) Width by Height	Bedford		Berkeley (Vertical)		Burley		Chevron		Cotswold		Gatcombe		Hampshire		Horizontal	
	C	R	C	R	C	R	C	R	C	R	C	R	C	R	C	R
1981 (6'6")	1697	1739	1468	1509	1468	1509	1468	1509	1468	1509	1468	1509	1665	1685	1239	1280
2134 (7'0")	1697	1739	1511	1552	1511	1552	1511	1552	1511	1552	1511	1552	1737	1757	1261	1302
2286 (7'6")	1896	1937	1603	1644	1603	1644	1603	1644	1603	1644	1603	1644	1863	1883	1311	1352
2438 (8'0")	2019	2060	1619	1660	1619	1660	1572	1612	1572	1612	1572	1612	1971	1991	1369	1409

Size availability (mm)

Minimum width	1778	1778	1778	1778	1778	1778	1778	1778	1778	1778	1778	1778	1778	1778	1778	1778
Maximum width	2438	2438	2438	2438	2438	2438	2438	2438	2438	2438	2438	2438	2438	2438	2438	2438
Minimum height	1778	1829	1778	1829	1778	1829	1778	1829	1778	1829	1778	1829	1778	1829	1778	1829
Maximum height	2134	2438	2134	2438	2134	2438	2134	2438	2134	2438	2134	2438	2134	2438	2134	2438

C = Canopy gear, R = Retractable gear.

Timber up and over single doors - options

Fully finished	add £122
Finishes available	Light Oak, Mahogany, Walnut, Burnt Oak Silver, Silver Grey, Rosewood & Ebony
Brass effect handle	add £46
Draught strip	add £31
Frame 54mm/68mm	add £98 (Pre-finished or white painted)
Golden Oak & Rosewood frame 54mm/68mm	add £403 (Golden Oak & Rosewood)
Coloured frame 54mm/68mm	add £134 (Coloured painted)
Cardale 650 operator	add £376
Canopy converter	add £98
Cardale 800 operator	add £487

Please see page 36 for side hinged options

Glazing (Bedford)	No extra charge (Stippled as standard)
Glazing (Cotswold)	Plain black, Stippled, Transparent, Diamond lattice, Queen Anne lattice, Square lattice (Cotswold only at no extra cost)
Glazing (Ibstock & Strathmore)	No extra charge (Stippled as standard)

Optional extras for operators

Extra handsets	add £56 (2 channel) add £62 (4 channel)
Wireless key pad	add £155
External manual override	add £36
Keypad	add £39

Single door (Standard)

Size mm (ft/in) Width by Height	Ibstock		Kent		Strathmore		Vertical	
	C	R	C	R	C	R	C	R
2134 x 1981 (7'0" x 6'6")	1630	1650	1585	1605	1655	1675	1178	1279
2134 x 2134 (7'0" x 7'0")	1655	1675	1657	1677	1669	1689	1178	1279
2134 x 2286 (7'0" x 7'6")	-	1684	-	1955	-	1941	-	1289
2134 x 2438 (7'0" x 8'0")	-	1776	-	2042	-	-	-	1380
2286 x 1981 (7'6" x 6'6")	1725	1745	1775	1795	1854	1874	1215	1255
2286 x 2134 (7'6" x 7'0")	1990	2010	1783	1803	1885	1905	1255	1277
2286 x 2286 (7'6" x 7'6")	-	2014	-	2129	-	2050	-	1326
2286 x 2438 (7'6" x 8'0")	-	2053	-	2281	-	2107	-	1549
2438 x 1981 (8'0" x 6'6")	1732	1752	1842	1862	2156	2176	1297	1301
2438 x 2134 (8'0" x 7'0")	1765	1785	1891	1911	2191	2211	1322	1364

Single door (Made to measure)

Width (up to) mm (ft/in) Width by Height	Ibstock		Kent		Strathmore		Vertical	
	C	R	C	R	C	R	C	R
1981 (6'6")	1710	1730	1665	1685	1735	1755	1239	1280
2134 (7'0")	-	1784	1737	1757	1749	1769	1261	1302
2286 (7'6")	2070	2090	1863	1883	1965	1985	1311	1352
2438 (8'0")	1845	1865	1971	1991	2271	2291	1369	1409

Size availability (mm)

Minimum width	1778	1778	1778	1778	1778	1778	1778	1778
Maximum width	2438	2438	2438	2438	2438	2438	2438	2438
Minimum height	1778	1829	1778	1829	1778	1829	1778	1829
Maximum height	2134	2438	2134	2438	2134	2438	2134	2438

NEW Timber doors - Elegant Range Futura infill doors

Single door (Standard)

Size mm (ft/in) Width by Height	Timber Georgian		Timber Sheraton		Timber Brompton		Timber Jacobean	
	C	R	C	R	C	R	C	R
2134 x 1981 (7'0" x 6'6")	1717	1737	1717	1737	1717	1737	1717	1737
2134 x 2134 (7'0" x 7'0")	1745	1765	1745	1765	1745	1765	1745	1765
2134 x 2286 (7'0" x 7'6")	-	1820	-	1820	-	1820	-	1820
2134 x 2438 (7'0" x 8'0")	-	1875	-	1875	-	1875	-	1875
2286 x 1981 (7'6" x 6'6")	1804	1824	1804	1824	1804	1824	1804	1824
2286 x 2134 (7'6" x 7'0")	1832	1852	1832	1852	1832	1852	1832	1852
2286 x 2286 (7'6" x 7'6")	-	1889	-	1889	-	1889	-	1889
2286 x 2438 (7'6" x 8'0")	-	1928	-	1928	-	1928	-	1928
2438 x 1981 (8'0" x 6'6")	1824	1844	1824	1844	1824	1844	1824	1844
2438 x 2134 (8'0" x 7'0")	1862	1882	1862	1882	1862	1882	1862	1882

Single door (Made to measure)

Width (up to) mm (ft/in) Width by Height	Timber Georgian		Timber Sheraton		Timber Brompton		Timber Jacobean	
	C	R	C	R	C	R	C	R
1981 (6'6")	1897	1939	1897	1939	1897	1939	1897	1939
2134 (7'0")	1897	1939	1897	1939	1897	1939	1897	1939
2286 (7'6")	2096	2137	2096	2137	2096	2137	2096	2137
2438 (8'0")	2291	2260	2291	2260	2291	2260	2291	2260

Size availability (mm)

Minimum width	1778	1778	1778	1778	1778	1778	1778	1778
Maximum width	2438	2438	2438	2438	2438	2438	2438	2438
Minimum height	1778	1829	1778	1829	1778	1829	1778	1829
Maximum height	2134	2438	2134	2438	2134	2438	2134	2438

C = Canopy gear, R = Retractable gear.

Timber Elegant Range glazing options

Plain Black, Stippled Transparent, Diamond Lattice and Queen Anne Lattice add £201

Double door
(Standard)

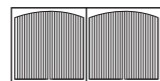
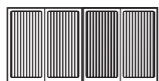
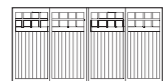

Size mm (ft/in)	Bedford R	Berkeley (Vertical) R	Burley R	Chevron R
2743 x 1981 (9'0" x 6'6")	1869	1830	1709	2089
2743 x 2134 (9'0" x 7'0")	1907	1851	1731	2140
2743 x 2438 (9'0" x 8'0")	1962	2054	1887	2512
3048 x 1981 (10'0" x 6'6")	2092	1879	1789	2197
3048 x 2134 (10'0" x 7'0")	2145	1950	1799	2260
3048 x 2438 (10'0" x 8'0")	2227	2069	1989	2532
3658x 1981 (12'0" x 6'6")	2575	2191	2240	2561
3658 x 2134 (12'0" x 7'0")	2597	2230	2260	2598
3658x 2438 (12'0" x 8'0")	2665	2349	2475	2760
4267 x 1981 (14'0" x 6'6")	3170	2421	2693	3068
4267 x 2134 (14'0" x 7'0")	3195	2429	2718	3099
4267 x 2438 (14'0" x 8'0")	3280	2679	2958	3357
4877 x 1981 (16'0" x 6'6")	3762	2998	3411	3709
4877 x 2134 (16'0" x 7'0")	3795	3031	3480	3736
4877 x 2438 (16'0" x 8'0")	3861	3184	3720	3984

Double door
(Made to measure)

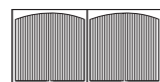
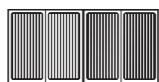
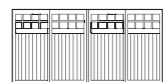

Width (up to) mm (ft/in)	Bedford R	Berkeley (Vertical) R	Burley R	Chevron R
2743 (9'0")	1982	2274	1907	2532
3048 (10'0")	2247	2468	2009	2552
3353 (11'0")	2466	2800	2252	2666
3658 (12'0")	2685	2940	2495	2780
3962 (13'0")	2992	3122	2736	3078
4267 (14'0")	3300	3195	2978	3377
4572 (15'0")	3596	3502	3359	3690
4877 (16'0")	3881	3725	3740	4004

Size availability (mm)

Minimum width	2438	2438	2438	2438
Maximum width	4877	4877	4877	4877
Minimum height	1854	1854	1854	1854
Maximum height	2438	2438	2438	2438

Please see page 26 for standard and made to measure double door options.

Double door
(Standard)

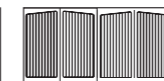

Size mm (ft/in)	Cotswold R	Gatcombe R	Hampshire R	Horizontal R	Ibstock R
2743 x 1981 (9'0" x 6'6")	1830	1711	2204	1720	2260
2743 x 2134 (9'0" x 7'0")	1911	1739	2268	1761	2298
2743 x 2438 (9'0" x 8'0")	2114	1882	2539	1797	2363
3048 x 1981 (10'0" x 6'6")	1980	1777	2313	1709	2399
3048 x 2134 (10'0" x 7'0")	2128	1794	2371	1764	2563
3048 x 2438 (10'0" x 8'0")	2177	2044	2547	1831	2630
3658x 1981 (12'0" x 6'6")	2518	2245	-	-	2987
3658 x 2134 (12'0" x 7'0")	2579	2267	-	-	2998
3658x 2438 (12'0" x 8'0")	2650	2463	-	-	3067
4267 x 1981 (14'0" x 6'6")	2987	2688	-	-	3580
4267 x 2134 (14'0" x 7'0")	3023	2729	-	-	3599
4267 x 2438 (14'0" x 8'0")	3189	2945	-	-	3685
4877 x 1981 (16'0" x 6'6")	3449	3432	-	-	4160
4877 x 2134 (16'0" x 7'0")	3487	3475	-	-	4198
4877 x 2438 (16'0" x 8'0")	3859	3726	-	-	4260

Double door
(Made to measure)

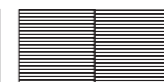
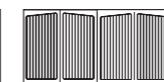

Width (up to) mm (ft/in)	Cotswold R	Gatcombe R	Hampshire R	Horizontal R	Ibstock R
2743 (9'0")	2321	1902	2559	1817	2383
3048 (10'0")	2381	2064	2567	1851	2650
3353 (11'0")	2995	2273	-	-	2868
3658 (12'0")	4269	2483	-	-	3087
3962 (13'0")	3860	2724	-	-	3396
4267 (14'0")	3833	2965	-	-	3705
4572 (15'0")	4191	3355	-	-	3992
4877 (16'0")	4562	3746	-	-	4280



Size availability (mm)

Minimum width	2438	2438	2438	2438	2438
Maximum width	4877	4877	3048	3048	4877
Minimum height	1854	1854	1854	1854	1854
Maximum height	2438	2438	2438	2438	2438

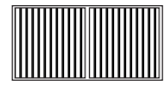
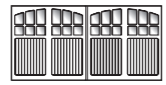
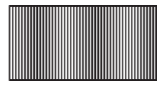
Double door
(Standard)

			
Size mm (ft/in)	Kent	Strathmore	Vertical
Width by Height	R	R	R
2743 x 1981 (9'0" x 6'6")	2204	2452	1735
2743 x 2134 (9'0" x 7'0")	2268	2477	1776
2743 x 2438 (9'0" x 8'0")	2539	2363	1812
3048 x 1981 (10'0" x 6'6")	2399	2677	1724
3048 x 2134 (10'0" x 7'0")	2563	2767	1779
3048 x 2438 (10'0" x 8'0")	2630	2893	1846
3658 x 1981 (12'0" x 6'6")	2689	2938	2278
3658 x 2134 (12'0" x 7'0")	2998	2985	2316
3658 x 2438 (12'0" x 8'0")	3067	3164	2399
4267 x 1981 (14'0" x 6'6")	3580	3515	2420
4267 x 2134 (14'0" x 7'0")	3599	3276	2438
4267 x 2438 (14'0" x 8'0")	3685	3748	2651
4877 x 1981 (16'0" x 6'6")	4160	3916	2873
4877 x 2134 (16'0" x 7'0")	4198	4147	2898
4877 x 2438 (16'0" x 8'0")	4260	4451	3087

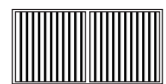
Double door
(Made to measure)

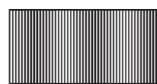
			
Width (up to) mm (ft/in)	Kent	Strathmore	Vertical
Width by Height	R	R	R
2743 (9'0")	2559	2383	2000
3048 (10'0")	2650	2918	2022
3353 (11'0")	2868	3048	2397
3658 (12'0")	3087	3184	2635
3962 (13'0")	3396	3476	2874
4267 (14'0")	3705	3768	2720
4572 (15'0")	3992	4119	3323
4877 (16'0")	4280	4471	3564

Size availability (mm)

Minimum width	2438	2438	2438
Maximum width	4877	4877	4877
Minimum height	1854	1854	1854
Maximum height	2438	2438	2438

R= Retractable









Timber up and over double doors - options

Fully finished	add £201
Finishes available	Light Oak, Mahogany, Walnut, Burnt Oak, Silver, Silver Grey, Rosewood & Ebony
Brass effect handle	add £46
Draught strip	add £61
Frame 54mm/68mm	add £175 (Pre-finished or white painted)
Coloured frame 54mm/68mm	add £211 (Coloured painted)
Golden Oak & Rosewood frame 68mm	add £304 (Golden Oak & Rosewood)
Cardale 650 operator	add £376
Cardale 800 operator	add £487
Glazing (Bedford)	No extra charge (Stippled as standard)
Glazing (Cotswold)	Plain black, Stippled, Transparent, Diamond lattice, Queen Anne lattice, Square lattice (Cotswold only at no extra cost)
Glazing (Ibstock & Strathmore)	No extra charge (Stippled as standard)









Optional extras for operators

Extra handsets	add £56 (2 channel) add £62 (4 channel)
Wireless key pad	add £155
External manual override	add £36
Keypad	add £39

Single door
(Standard)

									
Size mm (ft/in)	Bronte	Cardinal	Chiltern	Countryman	Hampstead	Hathaway	Stuart	Tudor	Windsor
Width by Height	C R	C R	C R	C R	C R	C R	C R	C R	C R
2134 x 1981 (7'0" x 6'6")	1230 1250	1155 1175	1155 1175	1155 1175	1436 1446	1436 1446	1095 1115	1025 1086	1055 1186
2134 x 2134 (7'0" x 7'0")	1250 1270	1185 1205	1185 1205	1185 1205	1480 1490	1480 1490	1123 1143	1028 1089	1158 1119
2134 x 2286 (7'0" x 7'6")	- 1357	- 1275	- 1275	- 1275	- 1632	- 1632	- 1188	- -	- -
2134 x 2438 (7'0" x 8'0")	- 1465	- 1374	- 1374	- 1374	- 1717	- 1717	- 1292	- -	- -
2286 x 1981 (7'6" x 6'6")	1296 1316	1186 1206	1186 1206	1186 1206	1663 1673	1663 1673	1156 1176	1041 1103	1071 1133
2286 x 2134 (7'6" x 7'0")	1322 1342	1212 1232	1212 1232	1212 1232	1693 1703	1693 1703	1172 1192	1042 1104	1072 1134
2286 x 2286 (7'6" x 7'6")	1374 1394	1324 1344	1324 1344	1324 1344	1731 1741	1731 1741	1244 1264	- -	- -
2286 x 2438 (7'6" x 8'0")	- 1489	- 1389	- 1389	- 1389	- 1877	- 1877	- 1343	- -	- -
2438 x 1981 (8'0" x 6'6")	1379 1399	1269 1289	1269 1289	1269 1289	1824 1834	1824 1834	1185 1205	1053 1116	1083 1146
2438 x 2134 (8'0" x 7'0")	1449 1469	1302 1322	1302 1322	1302 1322	1855 1865	1855 1865	1227 1247	1054 1118	1084 1148

Single door
(Made to measure)

									
Width (up to) mm (ft/in)	Bronte	Cardinal	Chiltern	Countryman	Hampstead	Hathaway	Stuart	Tudor	Windsor
Width by Height	C R	C R	C R	C R	C R	C R	C R	C R	C R
1981 (6'6")	1330 1350	1255 1275	1255 1275	1255 1275	1536 1546	1536 1546	1195 1215	1125 1186	1155 1286
2134 (7'0")	1350 1370	1285 1305	1285 1305	1285 1305	1580 1590	1580 1590	1223 1243	1128 1189	1258 1219
2286 (7'6")	1437 1457	1355 1375	1355 1375	1355 1375	1712 1732	1712 1732	1268 1288	1183 1203	1213 1233
2438 (8'0")	1545 1565	1454 1474	1454 1474	1454 1474	1797 1817	1797 1817	1272 1292	1196 1216	1226 1246

Size availability (mm)

Minimum width	1778 1778	1778 1778	1778 1778	1778 1778	1778 1778	1778 1778	1778 1778	1778 1778	1778 1778
Maximum width	2438 2438	2438 2438	2438 2438	2438 2438	2438 2438	2438 2438	2438 2438	2438 2438	2438 2438
Minimum height	1778 1829	1778 1829	1778 1829	1778 1829	1778 1829	1778 1829	1778 1829	1778 1829	1778 1829
Maximum height	2134 2438	2134 2438	2134 2438	2134 2438	2134 2438	2134 2438	2134 2438	2134 2438	2134 2438

C = Canopy gear, R = Retractable gear.

Timber up and over single doors - options

Fully finished	add £195
Finishes available	Light Oak, Mahogany, Walnut, Burnt Oak, Silver, Silver Grey, Rosewood & Ebony
Brass effect handle	add £46
Draught strip	add £31
Frame 54mm/68mm	add £98 (Pre-finished or white painted)
Golden Oak & Rosewood frame 54mm/68mm	add £201 (Golden Oak & Rosewood)
Coloured frame 54mm/68mm	add £134 (Coloured painted)

Cardale 650 operator	add £376
Canopy converter	add £98
Cardale 800 operator	add £487
Glazing (Hampstead) and Hathaway)	No extra charge (Stippled as standard)

**New Heritage doors
Single doors**

**Single door
(Standard)**

Size mm (ft/in) Width by Height	Bromley		Shropshire		Guildford	
	C	R	C	R	C	R
2134 x 1981 (7'0" x 6'6")	1230	1235	1230	1250	1230	1250
2134 x 2134 (7'0" x 7'0")	1250	1255	1250	1270	1250	1270
2134 x 2286 (7'0" x 7'6")	-	1342	-	1357	-	1357
2134 x 2438 (7'0" x 8'0")	-	1473	-	1465	-	1473
2286 x 1981 (7'6" x 6'6")	1296	1301	1296	1316	1296	1301
2286 x 2134 (7'6" x 7'0")	1322	1327	1322	1342	1322	1327
2286 x 2286 (7'6" x 7'6")	-	1379	-	1394	-	1379
2286 x 2438 (7'6" x 8'0")	-	1474	-	1489	-	1475

**Single door
(Made to measure)**

Width (up to) mm (ft/in) Width by Height	Bromley		Shropshire		Guildford	
	C	R	C	R	C	R
1981 (6'6")	1330	1335	1330	1350	1330	1335
2134 (7'0")	1350	1355	1350	1370	1330	1335
2286 (7'6")	1422	1442	1437	1457	1422	1442
2438 (8'0")	1553	1573	1545	1565	1553	1573

Size availability (mm)

Minimum width	1778	1778	1778	1778	1778	1778
Maximum width	2438	2438	2438	2438	2438	2438
Minimum height	1778	1829	1778	1829	1778	1829
Maximum height	2134	2438	2134	2438	2134	2438

Glazing for Bromley, Shropshire and Guildford

Add £201 (Stippled as standard)

Optional extras for operators

Extra handsets	add £56 (2 channel) add £62 (4 channel)
Wireless key pad	add £155
External manual override	add £36
Keyswitch	add £39

**Side Hinged
(Standard)**

Size mm (ft/in) Width by Height	Malvern	Milton	Rutland	Shakespeare
	2134 x 1981 (7'0" x 6'6")	1500	1505	1430
2134 x 2134 (7'0" x 7'0")	1527	1532	1457	1457
2286 x 1981 (7'6" x 6'6")	1548	1553	1478	1478
2286 x 2134 (7'6" x 7'0")	1569	1574	1499	1499
2438 x 1981 (8'0" x 6'6")	1668	1673	1598	1598
2438 x 2134 (8'0" x 7'0")	1716	1721	1646	1646

**Side Hinged
(Made to measure)**

Size mm (ft/in) Width by Height	Malvern	Milton	Rutland	Shakespeare
	1981 x 1981 (6'6" x 6'6")	1579	1584	1503
2134 x 1981 (7'0" x 6'6")	1600	1605	1530	1530
2134 x 2134 (7'0" x 7'0")	1627	1632	1557	1557
2134 x 2286 (7'0" x 7'6")	1654	1659	1584	1584
2286 x 1981 (7'6" x 6'6")	1648	1653	1578	1578
2286 x 2134 (7'6" x 7'0")	1669	1674	1599	1599
2286 x 2286 (7'6" x 7'6")	1690	1695	1620	1620
2438 x 1981 (8'0" x 6'6")	1768	1773	1698	1698
2438 x 2134 (8'0" x 7'0")	1817	1821	1746	1746
2438 x 2286 (8'0" x 7'6")	1866	1869	1794	1794

Size availability (mm)

Minimum width	1778	1778	1778	1778
Maximum width	2438	2438	2438	2438
Minimum height	1829	1829	1829	1829
Maximum height	2438	2438	2438	2438

* Side hinged doors supplied with pre-finished white 65mm steel frame as standard.
Doors supplied as standard right hand opening when viewed from outside.
All side hinged doors open outwards

Heritage Timber side hinged doors - options

Fully finished	£195
Unframed	deduct £40
Painted frame 65mm	add £21
Security & draught fur pack	add £129
Left hand opening	add £57
Cardale 650	add £376
Side hinged converter	add £143(50/50 only)
Glazing (Milton)	add £103 (Stippled as standard)

**Double door
(Standard)**

Size mm (ft/in) Width by Height	Cardinal	Chiltern	Countryman	Hampstead	Hathaway	Stuart
	R	R	R	R	R	R
2743 x 1981 (9'0" x 6'6")	1605	1605	1605	2431	2151	1536
2743 x 2134 (9'0" x 7'0")	1637	1637	1637	2449	2169	1555
2743 x 2438 (9'0" x 8'0")	1712	1712	1712	2509	2229	1631
3048 x 1981 (10'0" x 6'6")	1722	1722	1722	2667	2387	1640
3048 x 2134 (10'0" x 7'0")	1767	1767	1767	2711	2431	1697
3048 x 2438 (10'0" x 8'0")	1969	1969	1969	2910	2630	1829
3658 x 1981 (12'0" x 6'6")	2120	2120	2120	2839	2559	2031
3658 x 2134 (12'0" x 7'0")	2139	2139	2139	2861	2581	2068
3658 x 2438 (12'0" x 8'0")	2279	2279	2279	3048	2768	2190
4267 x 1981 (14'0" x 6'6")	2472	2472	2472	3470	3190	2100
4267 x 2134 (14'0" x 7'0")	2485	2485	2485	3499	3219	2111
4267 x 2438 (14'0" x 8'0")	2633	2633	2633	3730	3450	2349
4877 x 1981 (16'0" x 6'6")	3059	3059	3059	3849	3569	2989
4877 x 2134 (16'0" x 7'0")	3130	3130	3130	3890	3610	3071
4877 x 2438 (16'0" x 8'0")	3257	3257	3257	4155	3875	3200

**Double door
(Made to measure)**

Width (up to) mm (ft/in) Width by Height	Cardinal	Chiltern	Countryman	Hampstead	Hathaway	Stuart
	R	R	R	R	R	R
2743 (9'0")	1862	1862	1862	2659	2379	1781
3048 (10'0")	2119	2119	2119	3060	2780	1979
3353 (11'0")	2275	2274	2274	3129	2849	2159
3658 (12'0")	2429	2429	2429	3198	2918	2340
3962 (13'0")	2606	2606	2606	3539	3539	2419
4267 (14'0")	2783	2783	2783	3880	3600	2499
4572 (15'0")	3095	3095	3095	4092	3812	2924
4877 (16'0")	3407	3407	3407	4305	4025	3350

Size availability (mm)

Minimum width	2438	2438	2438	2438	2438	2438
Maximum width	4877	4877	4877	4877	4877	4877
Minimum height	1854	1854	1854	1854	1854	1854
Maximum height	2438	2438	2438	2438	2438	2438

Please see page 26 for standard and made to measure double door options.

Double door (Standard)

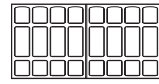
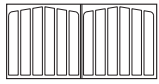
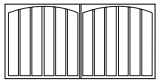
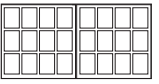
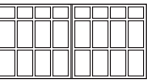
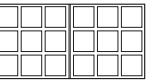
Size mm (ft/in) Width by Height						
	Thornley R	Tudor R	Windsor R	Bromley R	Shropshire R	Guildford R
2743 x 1981 (9'0" x 6'6")	1802	1605	1605	1802	1802	1802
2743 x 2134 (9'0" x 7'0")	1839	1637	1637	1839	1839	1839
2743 x 2438 (9'0" x 8'0")	1909	1712	1712	1909	1909	1909
3048 x 1981 (10'0" x 6'6")	2023	1722	1722	2023	2023	2023
3048 x 2134 (10'0" x 7'0")	2053	1767	1767	2053	2053	2053
3048 x 2438 (10'0" x 8'0")	2169	1969	1969	2169	2169	2169
3658x 1981 (12'0" x 6'6")	2483	2120	2120	2483	2483	2483
3658 x 2134 (12'0" x 7'0")	2539	2139	2139	2539	2539	2539
3658x 2438 (12'0" x 8'0")	2679	2279	2279	2679	2679	2679
4267 x 1981 (14'0" x 6'6")	2868	2472	2472	2868	2868	2868
4267 x 2134 (14'0" x 7'0")	2899	2485	2485	2899	2899	2899
4267 x 2438 (14'0" x 8'0")	3031	2633	2633	2031	2031	2031
4877 x 1981 (16'0" x 6'6")	3159	3059	3059	3159	3159	3159
4877 x 2134 (16'0" x 7'0")	3229	3130	3130	3229	3229	3229
4877 x 2438 (16'0" x 8'0")	3355	3257	3257	3355	3355	3355

Double door (Made to measure)

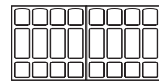
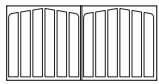
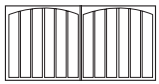
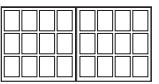
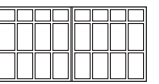
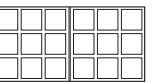
Width (up to) mm (ft/in) Width by Height						
	Thornley R	Tudor R	Windsor R	Bromley R	Shropshire R	Guildford R
2743 (9'0")	2059	1862	1862	2059	2059	2059
3048 (10'0")	2319	2119	2119	2319	2319	2319
3353 (11'0")	2574	2274	2274	2574	2574	2574
3658 (12'0")	2829	2429	2429	2829	2829	2829
3962 (13'0")	3005	2606	2606	3005	3005	3005
4267 (14'0")	3181	2783	2783	3181	3181	3181
4572 (15'0")	3343	3095	3095	3343	3343	3343
4877 (16'0")	3505	3407	3407	3505	3505	3505

Size availability (mm)

	Thornley	Tudor	Windsor	Bromley	Shropshire	Guildford
Minimum width	2438	2438	2438	2438	2438	2438
Maximum width	4877	4877	4877	4877	4877	4877
Minimum height	1854	1854	1854	1854	1854	1854
Maximum height	2438	2438	2438	2438	2438	2438

Please see page 26 for standard and made to measure double door options.









New Heritage range - double doors

Glazing for Bromley, Shropshire and Guildford

Add £402 (Stippled as standard)









Standard Pre-finished

**Size mm (ft/in)
Width by Height**

								
	Bedford (1/2 - 1/2)	Berkeley (1/2 - 1/2)	Brompton (1/2 - 1/2)	Gatcombe (1/2 - 1/2)	Gemini (1/2 - 1/2, 2/3 - 1/3)	Georgian (2/3 - 1/3)	Olympian (1/2 - 1/2)	Vogue (1/2 - 1/2)
1981 x 1981 (6'6" x 6'6")	-	-	982	-	908	982	-	1157
1981 x 2134 (6'6" x 7'0")	-	-	993	-	918	982	-	1169
2134 x 1981 (7'0" x 6'6")	1241	1141	993	1141	889	993	1155	1133
2134 x 2134 (7'0" x 7'0")	1272	1172	1024	1072	939	1024	1184	1194
2286 x 1981 (7'6" x 6'6")	1320	1220	1072	1120	962	1072	1237	1222
2286 x 2134 (7'6" x 7'0")	1398	1298	1151	1198	1015	1151	1323	1294
2438 x 1981 (8'0" x 6'6")	1428	1328	1180	1228	1028	1180	1356	1301
2438 x 2134 (8'0" x 7'0")	1488	1388	1207	1255	1041	1207	1396	1317

Made to Measure Pre-finished

**Width (up to) mm (ft/in)
Width by Height**

								
	Bedford (1/2 - 1/2)	Berkeley (1/2 - 1/2)	Brompton (1/2 - 1/2)	Gatcombe (1/2 - 1/2)	Gemini (1/2 - 1/2, 2/3 - 1/3)	Georgian (2/3 - 1/3)	Olympian (1/2 - 1/2)	Vogue (1/2 - 1/2)
1981 x 1981 (6'6" x 6'6")	-	-	1021	-	1011	-	-	1260
1981 x 2134 (6'6" x 7'0")	-	-	1046	-	1021	-	-	1272
1981 x 2286 (6'6" x 7'6")	-	-	1071	-	1021	-	-	-
2134 x 1981 (7'0" x 6'6")	1344	1244	1096	1244	992	1096	1258	1236
2134 x 2134 (7'0" x 7'0")	1375	1275	1127	1275	1042	1127	1287	1297
2134 x 2286 (7'0" x 7'6")	1406	1306	1127	1306	1042	1127	1316	1358
2286 x 1981 (7'6" x 6'6")	1423	1323	1175	1323	1065	1175	1340	1325
2286 x 2134 (7'6" x 7'0")	1501	1401	1254	1401	1118	1254	1426	1397
2286 x 2286 (7'6" x 7'6")	1579	1479	1254	1479	1118	1254	1512	1469
2438 x 1981 (8'0" x 6'6")	1531	1431	1283	1431	1131	1283	1459	1404
2438 x 2134 (8'0" x 7'0")	1591	1491	1310	1491	1144	1310	1499	1420
2438 x 2286 (8'0" x 7'6")	1651	1551	1310	1551	1144	1310	1539	1436

Size availability (mm)

	Bedford	Berkeley	Brompton	Gatcombe	Gemini	Georgian	Olympian	Vogue	
Minimum width	1829	2185	2185	1829	2185	1219	2134	1829	1829
Maximum width	2438	2438	2438	2438	2438	2438	2438	2438	2438
Minimum height	1981	1981	1918	1981	1829	1930	1905	1829	1829
Maximum height	2134	2134	2286	2134	2286	2134	2286	2286	2286

Steel side hinged doors - options

Unframed	deduct £40
Painted frame 65mm	add £21
Security & draught fur pack	add £129
Left hand opening	add £57
Cardale 650	add £376
Side hinged converter	add £143(50/50 only)
Glazing (Bedford)	add £103 (Stippled) Black mock glazing standard
Glazing (Brompton & Georgian)	add £201 (Stippled, Diamond Lattice, Square Lattice and Plain)

Painted door	add £98
Colours available	White, Ebony Black, Balmoral Green, Oxford Blue, Conker Brown, Monarch Red, Metallic Grey, Grey, Midnight Blue, Anthracite, Cherry & Burgundy

* Side hinged doors supplied with pre-finished white 65mm frame as standard. Doors supplied as standard right hand opening when viewed from outside. All side hinged doors open outwards.

**All side hinged doors come complete with door stay
Option of 50mm frame legs available with night latch,
38mm head and shoot bolt at no extra cost**

Standard

Golden Oak & Rosewood

Size mm (ft/in) Width by Height	Bedford (1/2 - 1/2)	Berkeley (Vertical) (1/2 - 1/2)	Brompton (1/2 - 1/2)	Gatcombe (1/2 - 1/2)	Gemini (1/2 - 1/2, 2/3 - 1/3)	Georgian (2/3 - 1/3)	Jacobean (1/2 - 1/2)	Sheraton (1/2 - 1/2)	Sheraton (Glazed) (1/2 - 1/2)	Vogue (1/2 - 1/2, 2/3 - 1/3)
1981 x 2134 (6'6" x 7'0")	-	-	-	-	1094	-	-	-	-	1313
1981 x 2134 (6'6" x 7'0")	-	-	-	-	1103	-	-	-	-	1324
2134 x 1981 (7'0" x 6'6")	1378	1278	1178	1278	1074	1178	1296	1178	1398	1289
2134 x 2134 (7'0" x 7'0")	1409	1309	1209	1309	1125	1209	1330	1209	1429	1350
2286 x 1981 (7'6" x 6'6")	1458	1358	1258	1358	1147	1258	1384	1258	1478	1376
2286 x 2134 (7'6" x 7'0")	1538	1438	1338	1438	1200	1338	1472	1338	1558	1440
2438 x 1981 (8'0" x 6'6")	1566	1466	1366	1466	1213	1366	1503	1366	1586	1457
2438 x 2134 (8'0" x 7'0")	1593	1493	1393	1493	1227	1393	1532	1393	1613	1472

Made to Measure

Golden Oak & Rosewood

Width (up to) mm (ft/in) Width by Height	Bedford (1/2 - 1/2)	Berkeley (Vertical) (1/2 - 1/2)	Brompton (1/2 - 1/2)	Gatcombe (1/2 - 1/2)	Gemini (1/2 - 1/2, 2/3 - 1/3)	Georgian (2/3 - 1/3)	Jacobean (1/2 - 1/2)	Sheraton (1/2 - 1/2)	Sheraton (Glazed) (1/2 - 1/2)	Vogue (1/2 - 1/2, 2/3 - 1/3)
1981 x 1981 (6'6" x 6'6")	-	-	-	-	1197	-	-	-	-	1436
1981 x 2134 (6'6" x 7'0")	-	-	-	-	1206	-	-	-	-	1447
1981 x 2286 (6'6" x 7'6")	-	-	-	-	1206	-	-	-	-	1447
2134 x 1981 (7'0" x 6'6")	1444	1344	1244	1344	1177	1244	1368	1244	1464	1412
2134 x 2134 (7'0" x 7'0")	1512	1412	1312	1412	1228	1312	1443	1312	1532	1474
2134 x 2286 (7'0" x 7'6")	1512	1412	1312	1412	1228	1312	1443	1312	1532	1474
2286 x 1981 (7'6" x 6'6")	1561	1461	1361	1461	1250	1361	1497	1361	1581	1500
2286 x 2134 (7'6" x 7'0")	1639	1539	1439	1539	1303	1439	1583	1439	1659	1564
2286 x 2286 (7'6" x 7'6")	1639	1539	1439	1539	1303	1439	1583	1439	1659	1564
2438 x 1981 (8'0" x 6'6")	1669	1569	1469	1569	1316	1469	1616	1469	1689	1579
2438 x 2134 (8'0" x 7'0")	1696	1596	1496	1596	1330	1496	1646	1496	1716	1596
2438 x 2286 (8'0" x 7'6")	1696	1596	1486	196	1330	1496	1646	1496	1716	1596

Size availability (mm)

Minimum width	2185	2185	1829	2185	1829	1219	2185	2185	2185	1829
Maximum width	2438	2438	2438	2438	2438	2438	2438	2438	2438	2438
Minimum height	1981	1981	1918	1981	1918	1829	1981*	1981*	1981*	1829
Maximum height	2134	2134	2286	2134	2286	2286	2134*	2134*	2134*	2286

Steel side hinged doors - options

Unframed	deduct £40
Painted frame 65mm	add £21
Security & draught fur pack	add £129
Left hand opening	add £57
Cardale 650	add £376
Side hinged converter	add £143(50/50 only)
Glazing (Bedford)	add £103 (Stippled) Black mock glazing standard
Glazing (Brompton & Georgian)	add £201 (Stippled, Diamond Lattice, Square Lattice and Plain)

Painted door	add £98
Golden Oak or Rosewood frame	add £195

* Side hinged doors supplied with pre-finished white 65mm frame as standard. Doors supplied as standard right hand opening when viewed from outside. All side hinged doors open outwards.

All side hinged doors come complete with door stays

Option of 50mm frame legs available with night latch, 38mm head and shoot bolt at no extra cost

* Only 1981 & 2134 heights

Standard

White Plastisol

Size mm (ft/in) Width by Height	Bedford (1/2 - 1/2)	Berkeley (Vertical) (1/2 - 1/2)	Brompton (1/2 - 1/2)	Chevron (1/2 - 1/2)	Gatcombe (1/2 - 1/2)	Gemini (1/2 - 1/2, 2/3 - 1/3)	Georgian (2/3 - 1/3)	Jacobean (1/2 - 1/2)	Olympian (1/2 - 1/2)
1981 x 2134 (6'6" x 7'0")	-	-	1016	-	-	1006	1016	1016	-
1981 x 2134 (6'6" x 7'0")	-	-	1041	-	-	1016	1041	1041	-
2134 x 1981 (7'0" x 6'6")	1291	1191	1091	1091	1191	986	1091	1091	1200
2134 x 2134 (7'0" x 7'0")	1322	1222	1122	1122	1222	1037	1122	1122	1234
2286 x 1981 (7'6" x 6'6")	1370	1270	1170	1170	1270	1060	1170	1170	1287
2286 x 2134 (7'6" x 7'0")	1448	1348	1248	1248	1348	1112	1248	1248	1373
2438 x 1981 (8'0" x 6'6")	1478	1378	1278	1278	1378	1126	1278	1278	1406
2438 x 2134 (8'0" x 7'0")	1505	1405	1305	1305	1405	1139	1305	1305	1436

* Side hinged doors supplied with pre-finished white 65mm frame as standard. Doors supplied as standard right hand opening when viewed from outside. All side hinged doors open outwards.

Made to Measure

White Plastisol

Width (up to) mm (ft/in) Width by Height	Bedford (1/2 - 1/2)	Berkeley (Vertical) (1/2 - 1/2)	Brompton (1/2 - 1/2)	Chevron (1/2 - 1/2)	Gatcombe (1/2 - 1/2)	Gemini (1/2 - 1/2, 2/3 - 1/3)	Georgian (2/3 - 1/3)	Jacobean (1/2 - 1/2)	Olympian (1/2 - 1/2)
1981 x 1981 (6'6" x 6'6")	-	-	1119	-	-	1109	1119	1119	1238
1981 x 2134 (6'6" x 7'0")	-	-	1144	-	-	1119	1144	1144	1263
1981 x 2286 (6'6" x 7'6")	-	-	1169	-	-	1119	1169	-	-
2134 x 1981 (7'0" x 6'6")	-	-	1194	-	-	1090	1194	1194	1313
2134 x 2134 (7'0" x 7'0")	-	-	1225	-	-	1140	1225	1225	1348
2134 x 2286 (7'0" x 7'6")	-	-	1225	-	-	1107	1225	-	1348
2286 x 1981 (7'6" x 6'6")	-	-	1273	-	-	1163	1273	1273	1400
2286 x 2134 (7'6" x 7'0")	-	-	1351	-	-	1215	1351	1351	1486
2286 x 2286 (7'6" x 7'6")	-	-	1351	-	-	1215	1351	-	1486
2438 x 1981 (8'0" x 6'6")	-	-	1381	-	-	1229	1381	1381	1519
2438 x 2134 (8'0" x 7'0")	-	-	1409	-	-	1242	1409	1408	1550
2438 x 2286 (8'0" x 7'6")	-	-	1408	-	-	1242	1408	-	1549

Size availability (mm)



Minimum width	-	-	1829	-	-	1219	2134	2134	1829
Maximum width	-	-	2438	-	-	2438	2438	2438	2438
Minimum height	-	-	1829	-	-	1829	1930	1981	1829
Maximum height	-	-	2286	-	-	2286	2134	2134	2134

Please see page 34 for side hinged options

* Side hinged doors supplied with pre-finished white 65mm frame as standard. Doors supplied as standard right hand opening when viewed from outside. All side hinged doors open outwards.



Standard

White Plastisol

Size mm (ft/in) Width by Height	 Sheraton (1/2 - 1/2)	 Sheraton (Glazed) (1/2 - 1/2)	 Vogue (1/2 - 1/2)
1981 x 2134 (6'6" x 7'0")	-	-	1207
1981 x 2134 (6'6" x 7'0")	-	-	1219
2134 x 1981 (7'0" x 6'6")	1091	1311	1183
2134 x 2134 (7'0" x 7'0")	1122	1342	1244
2286 x 1981 (7'6" x 6'6")	1170	1390	1272
2286 x 2134 (7'6" x 7'0")	1248	1468	1334
2438 x 1981 (8'0" x 6'6")	1278	1498	1351
2438 x 2134 (8'0" x 7'0")	1305	1525	1367

Made to Measure

White Plastisol

Width (up to) mm (ft/in) Width by Height	 Sheraton (1/2 - 1/2)	 Sheraton (Glazed) (1/2 - 1/2)	 Vogue (1/2 - 1/2)
1981 x 1981 (6'6" x 6'6")	-	-	1331
1981 x 2134 (6'6" x 7'0")	-	-	1343
1981 x 2286 (6'6" x 7'6")	-	-	1343
2134 x 1981 (7'0" x 6'6")	1194	1414	1308
2134 x 2134 (7'0" x 7'0")	1225	1445	1368
2134 x 2286 (7'0" x 7'6")	-	-	1328
2286 x 1981 (7'6" x 6'6")	1273	1493	1396
2286 x 2134 (7'6" x 7'0")	1351	1571	1458
2286 x 2286 (7'6" x 7'6")	-	-	1458
2438 x 1981 (8'0" x 6'6")	1381	1601	1475
2438 x 2134 (8'0" x 7'0")	1408	1628	1490
2438 x 2286 (8'0" x 7'6")	-	-	1490

Size availability (mm)

Minimum width	2134	2134	1219
Maximum width	2438	2438	2438
Minimum height	1981	1981	1800
Maximum height	2134	2134	2286

Plastisol side hinged doors - options









Unframed	deduct £40
Painted frame 65mm	add £21
Plastisol frame 65mm	add £103
Security & draught fur pack	add £129
Left hand opening	add £57
Cardale 650 operator	add £376
Side hinged converter	add £143 (50/50 only)
Glazing (Bedford)	add £103 (Stippled) Black mock glazing standard
Glazing (Brompton & Georgian)	add £201 (Stippled, Diamond Lattice, Square Lattice and Plain)
Glazing (Sheraton)	Plain black, Stippled, Transparent, Diamond lattice, Queen Anne lattice, Square lattice (Sheraton only at no extra cost)

All side hinged doors come complete with door stays

Option of 50mm frame legs available with night latch,
38mm head and shoot bolt at no extra cost









Side Hinged

(Standard)

Size mm (ft/in) Width by Height	 Bedford (1/2 - 1/2)	 Berkeley (Horizontal) (1/2 - 1/2)	 Berkeley (Vertical) (1/2 - 1/2)	 Jacobean (1/2 - 1/2)	 Regal (2/3 - 1/3)	 Senator (1/2 - 1/2)	 Tudor (1/2 - 1/2)	 Victoriana (1/2 - 1/2)
2134 x 1981 (7'0" x 6'6")	1355	1230	1230	1271	1230	1271	1271	1271
2134 x 2134 (7'0" x 7'0")	1355	1230	1230	1271	1230	1271	1271	1271
2286 x 1981 (7'6" x 6'6")	1444	1317	1317	1355	1317	1355	1355	1355
2286 x 2134 (7'6" x 7'0")	1444	1317	1317	1355	1317	1355	1355	1355
2438 x 1981 (8'0" x 6'6")	1520	1404	1404	1444	1404	1444	1444	1444
2438 x 2134 (8'0" x 7'0")	1520	1404	1404	1444	1404	1444	1444	1444

Side Hinged

(Made to measure)

Width (up to) mm (ft/in) Width by Height	 Bedford (1/2 - 1/2)	 Berkeley (Horizontal) (1/2 - 1/2)	 Berkeley (Vertical) (1/2 - 1/2)	 Jacobean (1/2 - 1/2)	 Regal (2/3 - 1/3)	 Senator (1/2 - 1/2)	 Tudor (1/2 - 1/2)	 Victoriana (1/2 - 1/2)
1981 x 1981 (6'6" x 6'6")	1487	1355	1355	1402	1355	1402	1402	1402
2134 x 1981 (7'0" x 6'6")	1487	1355	1355	1402	1355	1402	1402	1402
2134 x 2134 (7'0" x 7'0")	1487	1355	1355	1402	1355	1402	1402	1402
2134 x 2286 (7'0" x 7'6")	1590	1458	1458	1505	1458	1505	1505	1505
2286 x 1981 (7'6" x 6'6")	1573	1444	1444	1487	1444	1487	1487	1487
2286 x 2134 (7'6" x 7'0")	1573	1444	1444	1487	1444	1487	1487	1487
2286 x 2286 (7'6" x 7'6")	1676	1547	1547	1590	1547	1590	1590	1590
2438 x 1981 (8'0" x 6'6")	1658	1530	1530	1573	1530	1573	1573	1573
2438 x 2134 (8'0" x 7'0")	1658	1530	1530	1573	1530	1573	1573	1573
2438 x 2286 (8'0" x 7'6")	1761	1633	1633	1676	1633	1676	1676	1676

Size availability (mm)

Minimum width	2032	1987	1987	1987	1861	1981	1987	1987
Maximum width	2438	2438	2438	2438	2438	2438	2438	2438
Minimum height	1861	1895	1895	1895	1902	1829	1895	1829
Maximum height	2223	2203	2203	2203	2261	2261	2203	2261

* Side hinged doors supplied with pre-finished white 65mm frame as standard. Doors supplied as standard right hand opening when viewed from outside.
All side hinged doors open outwards









ABS side hinged doors - options

Unframed	deduct £40	Glazing (Bedford)	add £103 (Stippled) Black mock glazing standard
Painted frame 65mm	add £21	Glazing (Senator)	add £227 Plain black, Stippled, Transparent, Diamond lattice, Queen Anne lattice, Square lattice
Colours	add £98		
Security & draught fur pack	add £129		
Left hand opening	add £57		
Cardale 650 operator	add £376		
Side hinged converter	add £143 (50/50 only)		









All side hinged doors come complete with door stays

Option of 50mm frame legs available with night latch,
38mm head and shoot bolt at no extra cost

Side Hinged (Standard)

Size mm (ft/in) Width by Height	 Bedford (1/2 - 1/2)	 Chevron (1/2 - 1/2)	 Garage Light (1/2 - 1/2)	 Gatcombe (1/2 - 1/2)	 Hampshire (1/2 - 1/2)	 Ibstock (2/3 - 1/3)	 Kent (1/2 - 1/2)	 Vertical (1/2 - 1/2)
2134 x 1981 (7'0" x 6'6")	1756	1625	1756	1616	1830	1866	1830	1525
2134 x 2134 (7'0" x 7'0")	1785	1642	1785	1625	1850	1887	1850	1542
2286 x 1981 (7'6" x 6'6")	1883	1731	1883	1667	1880	1994	1880	1567
2286 x 2134 (7'6" x 7'0")	1947	1777	1947	1698	1917	2049	1917	1598
2438 x 1981 (8'0" x 6'6")	2013	1855	2013	1782	2018	2128	2018	1682
2438 x 2134 (8'0" x 7'0")	2045	1895	2045	1825	2070	2155	2070	1725

Side Hinged (Made to measure)

Width (up to) mm (ft/in) Width by Height	 Bedford (1/2 - 1/2)	 Chevron (1/2 - 1/2)	 Garage Light (1/2 - 1/2)	 Gatcombe (1/2 - 1/2)	 Hampshire (1/2 - 1/2)	 Ibstock (2/3 - 1/3)	 Kent (1/2 - 1/2)	 Vertical (1/2 - 1/2)
1981 x 1981 (6'6" x 6'6")	1786	1655	1786	1646	1836	1896	1866	1555
2134 x 1981 (7'0" x 6'6")	1806	1675	1806	1656	1890	1916	1890	1575
2134 x 2134 (7'0" x 7'0")	1835	1692	1835	1675	1910	1937	1910	1592
2134 x 2286 (7'0" x 7'6")	1882	1725	1882	1709	1983	1979	1983	1653
2286 x 1981 (7'6" x 6'6")	1933	1781	1933	1717	1940	2044	1940	1617
2286 x 2134 (7'6" x 7'0")	1997	1821	1997	1748	1977	2099	1977	1648
2286 x 2286 (7'6" x 7'6")	2056	1876	2056	1812	2052	2166	2052	1710
2438 x 1981 (8'0" x 6'6")	2063	1903	2063	1832	2078	2178	2078	1732
2438 x 2134 (8'0" x 7'0")	2095	1945	2095	1875	2130	2205	2130	1775
2438 x 2286 (8'0" x 7'6")	2134	1999	2134	1929	2194	2247	2194	1829

Size availability (mm)

Minimum width	1778	1778	1778	1778	1778	1778	1778	1778
Maximum width	2438	2438	2438	2438	2438	2438	2438	2438
Minimum height	1778	1778	1778	1778	1778	1778	1778	1778
Maximum height	2438	2438	2438	2438	2438	2438	2438	2438

* Side hinged doors supplied with pre-finished white 65mm frame as standard. Doors supplied as standard right hand opening when viewed from outside. All side hinged doors open outwards







Timber Heritage side hinged doors - options

Unframed	deduct £40	Glazing No extra charge (Stippled as standard) (Bedford, Garage Light, Ibstock)
Painted frame 65mm	add £21	
Colours	add £98	
Security & draught fur pack	add £129	
Left hand opening	add £57	
Cardale 650 operator	add £376	
Side hinged converter	add £143 (50/50 only)	

All side hinged doors come complete with door stays

Option of 50mm frame legs available with night latch, 38mm head and shoot bolt at no extra cost

Single door (Standard)

Size mm (ft/in) Width by Height	 Chelsea II (Glasswhite) C R		 Georgian II (Glasswhite) C R		 Hambledon II (Glasswood) C R		 Lyndhurst II (Glasswood) C R		 Nelson (Glasswood) C R		 Sutherland (Glasswood) C R	
2134 x 1981 (7'0" x 6'6")	1299	1343	1124	1163	1272	1316	1272	1316	1272	1316	1501	1545
2134 x 2134 (7'0" x 7'0")	1299	1343	1124	1163	1272	1316	1272	1316	1272	1316	1501	1545
2286 x 1981 (7'6" x 6'6")	1428	1472	1190	1234	1465	1509	1465	1509	1465	1509	1546	1590
2286 x 2134 (7'6" x 7'0")	1428	1472	1190	1234	1465	1509	1465	1509	1465	1509	1546	1590
2438 x 1981 (8'0" x 6'6")	1477	1521	1238	1282	1513	1557	1513	1557	1513	1557	1593	1637
2438 x 2134 (8'0" x 7'0")	1477	1521	1238	1282	1513	1557	1513	1557	1513	1557	1593	1637

Made to measure - Take next size up for price

Size availability (mm)

Minimum width	2057	2134	2134	2134	2134	2134	2134	2134	2057	2057	2134	2134
Maximum width	2438	2438	2438	2438	2438	2438	2438	2438	2438	2438	2438	2438
Minimum height	1981	1981	1930	1930	1981	1981	1930	1930	1981	1981	1930	1930
Maximum height	2134	2134	2134	2134	2134	2134	2134	2134	2134	2134	2134	2134

C = Canopy gear, R = Retractable gear.



GRP up and over single doors - options

Brass effect handle	add £46
Draught strip	add £31
Frame 54mm/68mm	add £98 (Pre-finished or white painted)
Coloured frame 54mm/68mm	add £134 (Coloured painted)
Cardale 650 operator	add £376
Canopy converter	add £98
Cardale 800 operator	add £487
RAL woodgrain colours	add £81
Glazing	add £250 Black, Stippled, Diamond Lattice & Square Lattice (Chelsea & Sutherland only at no extra cost)

Optional extras for operators

Extra handsets	add £56 (2 channel) add £62 (4 channel)
Wireless key pad	add £155
External manual override	add £36
Keypad	add £39

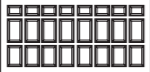
Double door
(Standard)

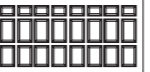
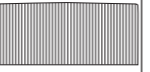
	 Chelsea II (Glasswhite) R	 Georgian II (Glasswhite) R	 Hambleton II (Glasswood) R	 Lyndhurst II (Glasswood) R	 Nelson (Glasswood) R
2591 x 1981 (8'6" x 6'6")	-	1653	1792	1792	-
2591 x 2134 (8'6" x 7'0")	-	1653	1792	1792	-
2743 x 1981 (9'0" x 6'6")	-	1653	-	1792	-
2743 x 2134 (9'0" x 7'0")	-	1653	-	1792	-
2896 x 1981 (9'6" x 6'6")	-	1808	-	1949	-
2896 x 2134 (9'6" x 7'0")	-	1808	-	1949	-
3048 x 1981 (10'0" x 6'6")	-	1808	-	1949	-
3048 x 2134 (10'0" x 7'0")	-	1808	-	1949	-
3353 x 1981 (11'0" x 6'6")	-	2021	-	2137	-
3353 x 2134 (11'0" x 7'0")	-	2021	-	2137	-
3658 x 1981 (12'0" x 6'6")	-	2177	-	2388	-
3658 x 2134 (12'0" x 7'0")	-	2177	-	2388	-
3962 x 1981 (13'0" x 6'6")	-	2218	-	2471	-
3962 x 2134 (13'0" x 7'0")	-	2218	-	2471	-
4267 x 1981 (14'0" x 6'6")	2395	2171	2446	2495	2446
4267 x 2134 (14'0" x 7'0")	2395	2171	2446	2495	2446
4420 x 1981 (14'6" x 6'6")	2791	2572	2856	2856	2856
4420 x 2134 (14'6" x 7'0")	2791	2572	2856	2856	2856

Made to measure - Take next size up for price

Size availability (mm)

Minimum width	2057	2134	2134	2083	2057
Maximum width	4420	4420	4420	4877	4420
Minimum height	1981	1930	1930	1930	1981
Maximum height	2134	2134	2134	2134	2134

R = Retractable gear.





GRP up and over double doors - options





Brass effect handle	add £46
Draught strip	add £61
Frame 54mm/68mm	add £175 (Pre-finished or white painted)
Coloured frame 54mm/68mm	add £211 (Coloured painted)
Cardale 650 operator	add £376
Cardale 800 operator	add £487
RAL woodgrain colours	add £134
Glazing	Black, Stippled, Diamond lattice & Square lattice (Chelsea only at no extra cost)

Optional extras for operators

Extra handsets	add £56 (2 channel) add £62 (4 channel)
Wireless key pad	add £155
External manual override	add £36
Keyswitch	add £39

Pre-finished steel

Size mm (ft/in)					
Door opening size	Overall frame size				
762 x 1981 (2'6" x 6'6")	892 x 2049 (2'11 1/4" x 6'8 3/4")	456	449	449	456
762 x 2134 (2'6" x 7'0")	892 x 2202 (2'11 1/4" x 7'2 3/4")	456	449	449	456
914 x 1981 (3'0" x 6'6")	1044 x 2049 (3'4 1/8" x 6'8 3/4")	558	550	550	558
914 x 2134 (3'0" x 7'0")	1044 x 2202 (3'4 1/8" x 7'2 3/4")	558	550	550	558
1219 x 1981 (4'0" x 6'6")	1349 x 2049 (4'4 1/8" x 6'8 3/4")	682	620	620	682
1219 x 2134 (4'0" x 7'0")	1349 x 2202 (4'4 1/8" x 7'2 3/4")	682	620	620	682

Size availability (mm)				
Minimum width	756	419	419	756
Maximum width	1067	1219	1219	1067
Minimum height	1829	1829	1829	1829
Maximum height	2134	2286	2286	2134

Options





White paint	add £41
Colours	add £67
Unframed	deduct £20
Painted frame	add £21
Security & draft fur pack	add £129
Glazing (Brompton) (Stippled & Plain)	add £95
Glazing (Georgian) (Stippled & Plain)	add £95





* Personnel doors supplied with pre-finished 65mm white frame as standard

Made to measure - Take next standard size up and add £52

50mm frame available at no extra cost

Plastisol

Size mm (ft/in)					
Door opening size	Overall frame size				
762 x 1981 (2'6" x 6'6")	892 x 2049 (2'11 1/4" x 6'8 3/4")	523	516	516	523
762 x 2134 (2'6" x 7'0")	892 x 2202 (2'11 1/4" x 7'2 3/4")	523	516	516	523
914 x 1981 (3'0" x 6'6")	1044 x 2049 (3'4 1/8" x 6'8 3/4")	625	617	617	625
914 x 2134 (3'0" x 7'0")	1044 x 2202 (3'4 1/8" x 7'2 3/4")	625	617	617	625
1219 x 1981 (4'0" x 6'6")	1349 x 2049 (4'4 1/8" x 6'8 3/4")	749	687	687	749
1219 x 2134 (4'0" x 7'0")	1349 x 2202 (4'4 1/8" x 7'2 3/4")	749	687	687	749

Size availability (mm)				
Minimum width	756	419	419	756
Maximum width	1067	1219	1219	1067
Minimum height	1829	1829	1829	1829
Maximum height	2134	2286	2286	2134

Options





Unframed	deduct £20
Painted frame	add £21
Plastisol	add £77
Security & draft fur pack	add £129
Glazing (Brompton) (Stippled & Plain)	add £95
Glazing (Georgian) (Stippled & Plain)	add £95





* Personnel doors supplied with pre-finished 65mm white frame as standard

Made to measure - Take next standard size up and add £52

50mm frame available at no extra cost

Golden Oak & Rosewood

Size mm (ft/in)	Door opening size	Overall frame size	 Brompton	 Europa	 Gemini	 Georgian
762 x 1981 (2'6" x 6'6")	892 x 2049 (2'11 1/4" x 6'8 3/4")	585	585	578	578	585
762 x 2134 (2'6" x 7'0")	892 x 2202 (2'11 1/4" x 7'2 3/4")	585	585	578	578	585
914 x 1981 (3'0" x 6'6")	1044 x 2049 (3'4 1/8" x 6'8 3/4")	687	687	679	679	687
914 x 2134 (3'0" x 7'0")	1044 x 2202 (3'4 1/8" x 7'2 3/4")	687	687	679	679	687
1219 x 1981 (4'0" x 6'6")	1349 x 2049 (4'4 1/8" x 6'8 3/4")	811	811	749	749	811
1219 x 2134 (4'0" x 7'0")	1349 x 2202 (4'4 1/8" x 7'2 3/4")	811	811	749	749	811

Size availability (mm)	 Brompton	 Europa	 Gemini	 Georgian
Minimum width	756	419	419	756
Maximum width	1067	1219	1219	1067
Minimum height	1829	1829	1829	1829
Maximum height	2134	2286	2286	2134

Options

Unframed	deduct £20
Painted frame	add £21
Golden Oak & Rosewood frame	add £134
Security & draft fur pack	add £129
Glazing (Brompton) (Stippled & Plain)	add £95
Glazing (Georgian) (Stippled & Plain)	add £95
* Personnel doors supplied with pre-finished 65mm white frame as standard	
Made to measure - Take next standard size up and add £52	
50mm frame available at no extra cost	

ABS

Size mm (ft/in)	Door opening size	Overall frame size	 Regal
762 x 1981 (2'6" x 6'6")	892 x 2049 (2'11 1/4" x 6'8 3/4")	644	644
762 x 2134 (2'6" x 7'0")	892 x 2202 (2'11 1/4" x 7'2 3/4")	644	644
914 x 1981 (3'0" x 6'6")	1044 x 2049 (3'4 1/8" x 6'8 3/4")	729	729
914 x 2134 (3'0" x 7'0")	1044 x 2202 (3'4 1/8" x 7'2 3/4")	729	729
1219 x 1981 (4'0" x 6'6")	1349 x 2049 (4'4 1/8" x 6'8 3/4")	814	814
1219 x 2134 (4'0" x 7'0")	1349 x 2202 (4'4 1/8" x 7'2 3/4")	814	814

Size availability (mm)	 Regal
Minimum width	580
Maximum width	800
Minimum height	1905
Maximum height	2210

Options

Unframed	deduct £20
Painted frame	add £21
Security & draft fur pack	add £129
* Personnel doors supplied with pre-finished 65mm white frame as standard	
Made to measure - Take next standard size up and add £52	
50mm frame available at no extra cost	
Glazing	add £95
(Stippled, Plain, Diamond Lattice, Square Lattice)	

Steeline roller door

Height mm (ft/in)	Curtain Width 'A' Series Opening + 50mm (2") minimum					Curtain Width 'AA' Series Opening + 100mm (4") minimum									
	2185 7'2"	2337 7'8"	2489 8'2"	2642 8'8"	2794 9'2"	2946 9'8"	3099 10'2"	3251 10'8"	3404 11'2"	3556 11'8"	3758 12'4"	4063 13'4"	4368 14'4"	4673 15'4"	4978 16'4"
2134 (7' 0")	637	653	688	722	745	839	869	956	1027	1162	1241	1347	1427	1566	1688
2134 (7' 0") - 2438 (8'0")	714	730	754	783	815	869	930	1018	1087	1271	1358	1505	1652	1746	1839
2438 (8'0") - 2743 (9'0")	799	823	866	887	917	954	1038	1161	1267	1404	1512	1671	1760	-	-
2743 (9'0") - 3048 (10'0")	904	958	988	995	1017	1053	1143	1296	1444	1596	1726	1826	2020	-	-

Ordering Notes

Steel-line doors are designed to fit behind the brickwork opening, allowing clear drive-through width*. Please therefore order by the curtain size, ensuring that the curtain width is greater than the opening by:

Series	Curtain width
'A' Series	Opening + 50mm (2") minimum
'AA' Series (solid areas)	Opening + 100mm (4") minimum

* The drive-through height is 80mm less than the nominal opening height

Mini steeline roller door

fits in 9" headroom - available in all Cardale colours

Height mm (ft/in)	Curtain Width mm (ft/in)						
	2185 7'2"	2337 7'8"	2489 8'2"	2642 8'8"	2794 9'2"	2946 9'8"	3099 10'2"
2134 (7' 0")	667	685	724	750	782	881	904

Textured Golden Oak or Rosewood - add 20% , Mahogany Woodgrain - add 7%

Doors are designed to fit behind the reveal, Doors are supplied with a lock hole unless specified otherwise

Sizes listed are the ordering sizes. These are the curtain sizes

Options available

Slimline slimdrive operator	add £411
Complete lock replacement	add £44
Replacement key	add £9.50
Touch up paint	add £15
Odd width cut down (applicable to doors under 4' wide)	add £69
Non standard brackets	add £50
Brush seal for header (3m length)	add £142

Standard colours:

White, Vandyke Brown, Black, Goosewing Grey, Merlin Grey, Terracotta, Olive Green, Juniper Green, Burgundy, Mushroom, Honesty Cream, Tangerine, Aztec Yellow, Poppy Red, Heritage Green, Solent Blue, Sargasso (Dark) Blue, Mahogany, Golden Oak, Rosewood

77mm insulated roller door

Coloured

Over guide width up to mm (ft/in)

Guide height mm (ft/in)	1981 (6'6")	2500 (8'2 3/8")	3000 (9'10 1/8")	3500 (11'5 1/4")	4000 (13'1 1/2")	4600 (15'1 1/8")	5200 (17'0 3/4")
1981 (6'6")	1159	1241	1360	1463	1663	1649	2050
2134 (7'0")	1169	1251	1375	1473	1674	1854	2060
2286 (7'6")	1200	1282	1401	1499	1766	1880	2178
2438 (8'0")	1226	1308	1488	1524	1782	2003	2194
2591 (8'6")	1329	1463	1566	1633	1942	2091	2395
2743 (9'0")	1349	1473	1576	1638	1978	2318	2524
2896 (9'6")	1349	1483	1612	1648	1988	2369	-

Colour options: white, buttermilk, dark brown, blue, dark green, burgundy, black and silver

Woodgrain

Over guide width up to mm (ft/in)

Guide height mm (ft/in)	1981 (6'6")	2500 (8'2 3/8")	3000 (9'10 1/8")	3500 (11'5 1/4")	4000 (13'1 1/2")	4600 (15'1 1/8")	5200 (17'0 3/4")
1981 (6'6")	1365	1514	1679	1828	2101	2364	2621
2134 (7'0")	1499	1519	1689	1838	2112	2369	2642
2286 (7'6")	1540	1581	1756	1900	2158	2436	2709
2438 (8'0")	1591	1617	1859	1962	2261	2601	2853
2591 (8'6")	1736	1859	1978	2163	2498	2776	2992
2743 (9'0")	1849	1869	1988	2163	2549	2781	3353
2896 (9'6")	1890	1906	2003	2184	2601	2879	-

Woodgrain options: golden oak, mahogany, rosewood and dark oak

Door width mm (ft/in)	1981 (6'6")	2500 (8'2 3/8")	3000 (9'10 1/8")	3500 (11'5 1/4")	4000 (13'1 1/2")	4600 (15'1 1/8")	5200 (17'0 3/4")
Half box	103	113	124	134	149	160	175
Full box	164	170	191	216	237	268	294

Thermaglide 77 doors are supplied with colour matched guide rails as standard. Up to 3 metre - 70mm guide rails. Over 3 metre - 90mm guide rails
Boxes are supplied white as standard.

55mm insulated roller door

Coloured

Over guide width up to mm (ft/in)

Guide height mm (ft/in)	1981 (6'6")	2500 (8'2 3/8")	3000 (9'10 1/8")
1981 (6'6")	1267	1298	1401
2134 (7'0")	1277	1308	1416
2286 (7'6")	1339	1406	1540

Colour options: white, mocca, green and black

Woodgrain

Over guide width up to mm (ft/in)

Guide height mm (ft/in)	1981 (6'6")	2500 (8'2 3/8")	3000 (9'10 1/8")
1981 (6'6")	1483	1597	1854
2134 (7'0")	1499	1612	1885
2286 (7'6")	1700	1751	1952

Colour options: golden oak and rosewood

Thermaglide 55 doors are supplied with 65mm colour matched guide rails and half box as standard. Boxes are supplied white as standard.





Thermaglide roller door - options

- Emergency manual override add £124
- Handset 1 button add £46
- Handset 4 button (large) add £46
- Handset 4 button (chrome) add £62
- Wired push button add £11
- Wireless push button add £67
- Wireless key pad add £155
- 98Db alarm add £52
- Wired key switch add £46
- Any standard RAL colour add £71/m³

Sectional

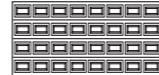
(Standard)

Size mm (ft/in)
Width x height

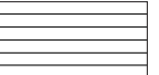
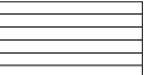

						
	Georgian (Panelled White) M	Georgian (Panelled White Glazed) M	Georgian (Panelled Golden Oak & Rosewood) M	Georgian (Panelled Golden Oak & Rosewood Glazed) M	Mid Rib (White) M	Mid Rib (Golden Oak & Rosewood) M
2074 x 1925 (6'10" x 6'4")	1105	1342	1240	1507	960	1120
2074 x 2075 (6'10" x 6'10")	1105	1342	1240	1507	960	1120
2134 x 2000 (7'0" x 6'6")	1105	1342	1240	1507	960	1120
2134 x 2125 (7'0" x 7'0")	1105	1342	1240	1507	960	1120
2226 x 1981 (7'4" x 6'4")	1105	1342	-	-	-	-
2226 x 1981 (7'4" x 6'10")	1105	1342	-	-	-	-
2286 x 1925 (7'6" x 6'4")	-	-	1430	1697	960	1160
2286 x 2000 (7'6" x 6'6")	1105	1342	1430	1697	960	1160
2286 x 2075 (7'6" x 6'10")	-	-	1430	1697	960	1160
2286 x 2125 (7'6" x 7'0")	1105	1342	1430	1697	960	1160
2378 x 1925 (7'10" x 6'4")	1220	1457	-	-	-	-
2378 x 2075 (7'10" x 6'10")	1220	1457	-	-	-	-
2438 x 1925 (8'0" x 6'4")	-	-	1430	1697	1120	1160
2438 x 2000 (8'0" x 6'6")	1220	1457	1430	1697	1120	1160
2438 x 2075 (8'0" x 6'10")	-	-	1430	1697	1120	1160
2438 x 2125 (8'0" x 7'0")	1220	1457	1430	1697	1120	1160
2591 x 1925 (8'6" x 6'4")	1290	1527	-	-	-	-
2591 x 2000 (8'6" x 6'6")	1290	1527	-	-	-	-
2591 x 2075 (8'6" x 6'10")	1290	1527	-	-	-	-
2591 x 2125 (8'6" x 7'0")	1290	1527	-	-	-	-
3000 x 1925 (9'10" x 6'4")	1520	1836	-	-	-	-
3000 x 2075 (9'10" x 6'10")	1520	1836	-	-	-	-
3048 x 1925 (10'0" x 6'4")	-	-	1710	2066	1180	1370
3048 x 2000 (10'0" x 6'6")	1520	1836	1710	2066	1180	1370
3048 x 2075 (10'0" x 6'10")	-	-	1710	2066	1180	1370
3048 x 2125 (10'0" x 7'0")	1520	1836	1710	2066	1180	1370
3292 x 1925 (10'10" x 6'4")	1625	1941	-	-	-	-
3292 x 2075 (10'10" x 6'10")	1625	1941	-	-	-	-
3353 x 2000 (11'0" x 6'6")	1625	1941	-	-	-	-
3353 x 2125 (11'0" x 7'0")	1625	1941	-	-	-	-
3657 x 1925 (12'0" x 6'4")	1680	2075	2299	2744	1599	1840
3657 x 2000 (12'0" x 6'6")	1680	2075	2299	2744	1599	1840
3657 x 2075 (12'0" x 6'10")	1680	2075	2299	2744	1599	1840
3657 x 2125 (12'0" x 7'0")	1680	2075	2299	2744	1599	1840
4207 x 1925 (13'10" x 6'4")	1510	1984	2130	2664	1433	1950
4207 x 2075 (13'10" x 6'10")	1510	1984	2130	2664	1433	1950
4267 x 2000 (14'0" x 6'6")	1510	1984	2130	2664	1433	1950
4267 x 2125 (14'0" x 7'0")	1510	1984	2130	2664	1433	1950
4360 x 1925 (14'4" x 6'4")	1510	1984	2490	3024	1433	2150
4360 x 2075 (14'4" x 6'10")	1510	1984	2490	3024	1433	2150
4420 x 2000 (14'6" x 6'6")	1510	1984	2490	3024	1433	2150
4420 x 2125 (14'6" x 7'0")	1510	1984	2490	3024	1433	2150
4817 x 1925 (15'10" x 6'4")	1850	2403	2590	3213	1750	2199
4817 x 2075 (15'10" x 6'10")	1850	2403	2590	3213	1750	2199
4877 x 2000 (16'0" x 6'6")	1850	2403	2590	3213	1750	2199
4877 x 2125 (16'0" x 7'0")	1850	2403	2590	3213	1750	2199
5500 x 1925 (18'1" x 6'4")	2475	3028	-	-	-	-
5500 x 2000 (18'1" x 6'6")	2475	3028	3195	3818	2250	2549
5500 x 2075 (18'1" x 6'10")	2475	3028	-	-	-	-
5500 x 2125 (18'1" x 7'0")	2475	3028	3195	3818	2250	2549

Optional extras: Cardale 650 operator £376 Cardale 800 Operator £487

Sectional

(Made to Measure)

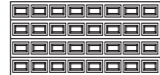
Size mm
Width x height

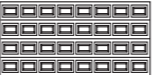
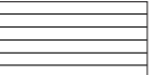
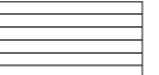
	 Georgian (Panelled White) M	 Georgian (Panelled White Glazed) M	 Georgian (Panelled Golden Oak & Rosewood) M	 Georgian (Panelled Golden Oak & Rosewood Glazed) M	 Mid Rib (White) M	 Mid Rib (Golden Oak & Rosewood) M
1981 to 2073 x 1925 or 2075	1194	1431	1329	1597	1049	1209
1981 to 2133 x 2000 or 2125	1194	1431	1329	1597	1049	1209
2076 to 2225 x 1925 or 2075	1194	1431	-	-	-	-
2076 to 2437 x 1925 or 2075	-	-	1519	1786	1049	1249
2135 to 2285 x 2000 or 2125	1194	1431	-	-	-	-
2135 to 2437 x 2000 or 2125	-	-	1519	1786	1049	1249
2227 to 2377 x 1925 or 2075	1309	1546	-	-	-	-
2287 to 2437 x 2000 or 2125	1309	1546	-	-	-	-
2379 to 2590 x 1925 or 2075	1379	1616	-	-	-	-
2439 to 3047 x 1925 or 2075	-	-	1519	1786	1109	1249
2439 to 3047 x 2000 or 2125	-	-	1519	1786	1109	1249
2489 to 2590 x 2000 or 2125	1379	1616	-	-	-	-
2592 to 2999 x 1925 or 2075	1599	1915	-	-	-	-
2592 to 3047 x 2000 or 2125	1599	1915	-	-	-	-
3001 to 3291 x 1925 or 2075	1714	2030	-	-	-	-
3049 to 3352 x 2000 or 2125	1714	2030	-	-	-	-
3049 to 3656 x 1925 or 2075	-	-	1799	2155	1269	1459
3049 to 3656 x 2000 or 2125	-	-	1799	2155	1269	1459
3293 to 3656 x 1925 or 2075	1769	2164	-	-	-	-
3353 to 3656 x 2000 or 2125	1769	2164	-	-	-	-
3658 to 4206 x 1925 or 2075	1599	2073	2388	2833	1688	1929
3658 to 4206 x 2000 or 2125	-	-	2388	2833	1688	1929
3658 to 4266 x 2000 or 2125	1599	2073	-	-	-	-
4208 to 4419 x 1925 or 2075	-	-	2219	2753	1532	2039
4208 to 4419 x 2000 or 2125	-	-	2219	2753	1532	2039
4268 to 4359 x 1925 or 2075	1599	2073	-	-	-	-
4268 to 4419 x 2000 or 2125	1599	2073	-	-	-	-
4361 to 4816 x 1925 or 2075	1939	2492	-	-	-	-
4421 to 4816 x 1925 or 2075	-	-	2579	3113	1532	2239
4421 to 4816 x 2000 or 2125	-	-	2579	3113	1532	2239
4421 to 4876 x 2000 or 2125	1939	2492	-	-	-	-
4818 to 4876 x 1925 or 2075	-	-	2679	3302	1839	2289
4818 to 4876 x 2000 or 2125	-	-	2679	3302	1839	2289
4818 to 5499 x 1925 or 2075	2564	3117	-	-	-	-
4878 to 5499 x 1925 or 2075	-	-	3284	3907	2339	2638
4878 to 5499 x 2000 or 2125	2564	3117	3284	3907	2339	2638

Sectional doors - options

M = Manual	Cover profile - white 2.5m length	85mm x 20mm (per pair)	add £45	Fully finished colour option for steel sectional overhead doors, to any RAL or BS colour (Excluding metallic or pearlescent finishes), price includes exterior face of door and fascia, also includes matching frame leg to cover specified. Per m ²
	Matching RAL colour 2.5m length	85mm x 20mm (per pair)	add £45	
		55mm x 20mm (per pair)	add £45	Standing locking with black 'D' handle
		55mm x 20mm (per pair)	add £45	No extra cost

Safelift Canopy Gear

Fitting to timber frame, **within the brickwork aperture**

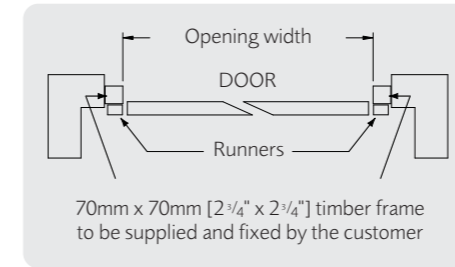

Fitting to timber frame, **behind the brickwork aperture**

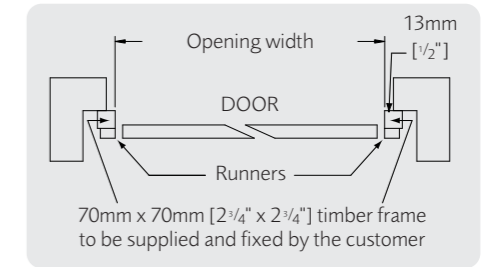

Fitting to Cardale 54mm Quick-fit steel SafeLift frame, **within the brickwork aperture**

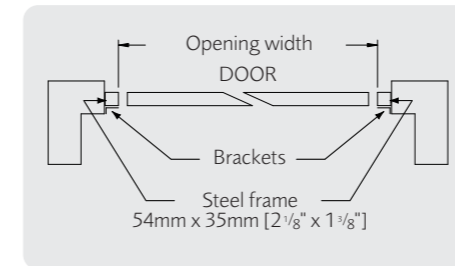

Fitting to Cardale 54mm Quick-fit steel SafeLift frame, **behind the brickwork aperture**

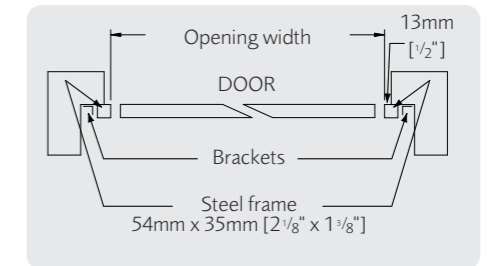

Fitting to Cardale 68mm Quick-fit steel SafeLift frame, **within the brickwork aperture**

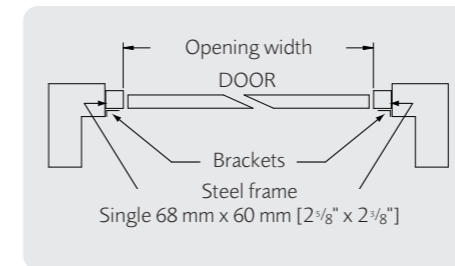

Fitting to Cardale 68mm Quick-fit steel SafeLift frame, **behind the brickwork aperture**

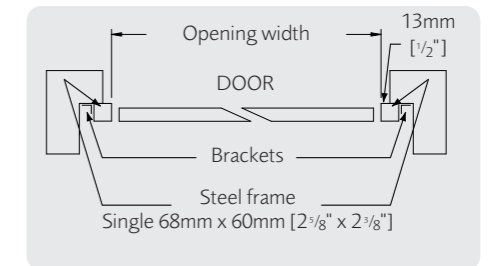

Opening arcs of travel

Cardale 1981mm [6'6"] High SafeLift Trackless Canopy Doors

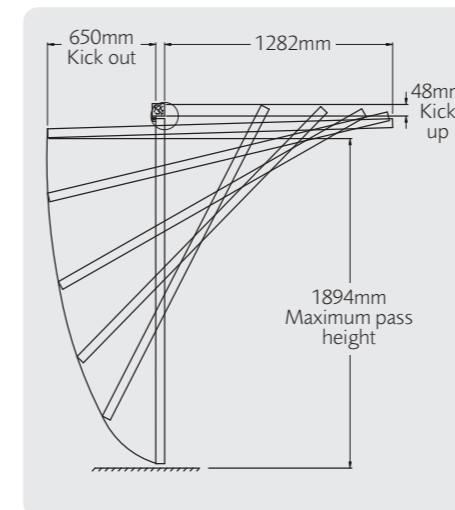

Cardale 2134mm [7'0"] High SafeLift Trackless Canopy Doors

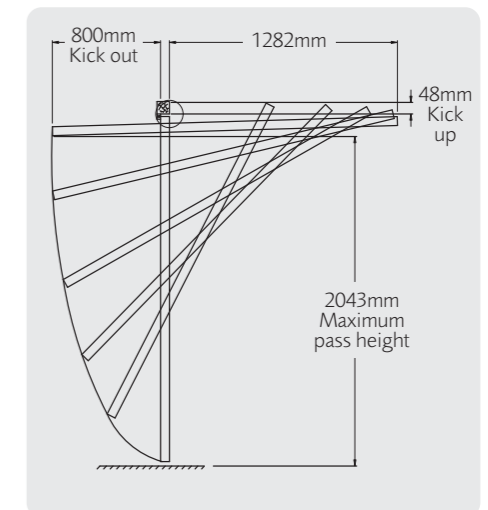

Maximizer® Retractable Gear

Fitting to timber frame, **within the brickwork aperture**

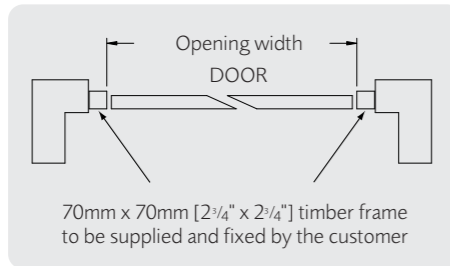

Fitting to timber frame, **behind the brickwork aperture**

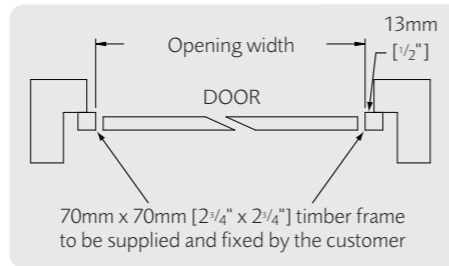

Fitting to Cardale Quick-fit steel Slideaway frame, **within the brickwork aperture**

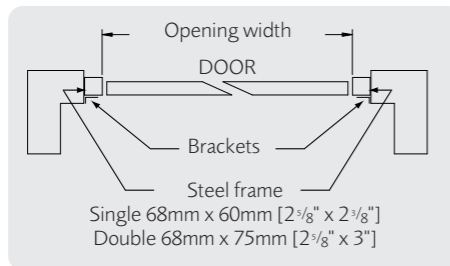

Fitting to Cardale Quick-fit steel Slideaway frame, **behind the brickwork aperture**

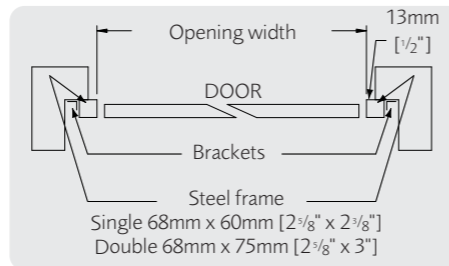

Fitting frames to the brickwork

Frames may be fitted within or behind the brickwork as per the drawings shown. Fitting behind the brickwork, if the garage length allows, will increase drive-through width by up to 114mm (4 1/2").

A 19mm x 19mm weatherbead should be fitted to the underside of the door frame lintel in front of the door to hide the top gap. This feature is integral on the Cardale Quick-fit steel frame.

Slideaway doors offer exceptionally smooth opening action and are ideal for electric operation.

Opening arcs of travel

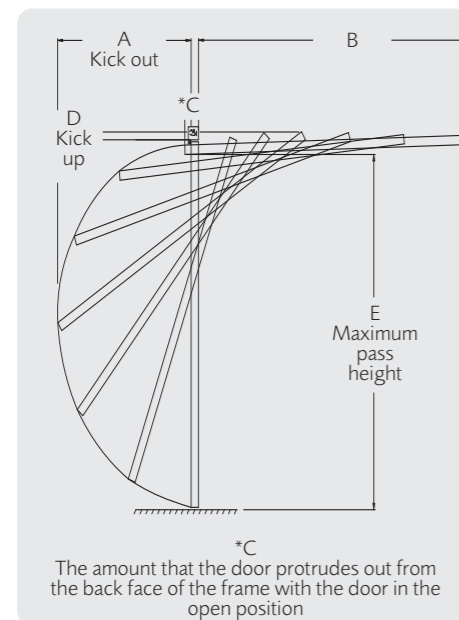

Key

	1981mm (6'6")	2134mm (7'0")
Size	high single	high single
Code	Maximizer doors	Maximizer doors
A	880mm	1030mm
B	1877mm	1877mm
*C	116mm	268mm
D	38.5mm	38.5mm
E	1884mm	2030mm
Size	1981mm (6'6")	2134mm (7'0")
Code	high double	high double
	Slideaway doors	Slideaway doors
A	900mm	1040mm
B	1877mm	1877mm
C	131mm	283mm
D	43mm	43mm
E	1890mm	2040mm

Safelift Canopy Gear



Standard door and brickwork aperture sizes

- It is recommended that Safelift Canopy is fitted to a weatherbeaded 70mm x 70mm timber "goalpost" frame, although the door can be fitted to a smaller side jamb down to a minimum of 45mm wide. This frame is not supplied. A Cardale Quick-fit steel frame can also be used. Safelift Canopy steel frame dimensions are 54mm wide on side section, 68mm high on top section and 35mm deep all round, plus there is also an option of a 68mm wide side jamb.
- The minimum headroom required above the lower face of the top timber or lintel is 65mm

Notes

Door sizes given represent opening sizes within the frame. Door leaves are approximately 19mm narrower and 25mm shorter to allow for operating clearances and tolerances. 'Within the brickwork' aperture dimensions include a 3mm gap between the frame and brickwork on all three sides to allow for coursing and tolerances. 'Behind the brickwork' aperture dimensions allow the frame to overlap into the aperture by a minimum of 13mm on both sides to allow for coursing and tolerances.

Brickwork aperture sizes for frames fitted WITHIN the opening

Size code	Door size	Timber frame (70 x 70mm)	54mm Quick-fit steel frame	68mm Quick-fit steel frame
		Brickwork aperture	Brickwork aperture	Brickwork aperture
6666	1981 x 1981mm	2127 x 2054mm	2095 x 2052mm	2123 x 2052mm
6670	1981 x 2134mm	2127 x 2207mm	2095 x 2205mm	2123 x 2205mm
7066	2134 x 1981mm	2280 x 2054mm	2248 x 2052mm	2276 x 2052mm
7070	2134 x 2134mm	2280 x 2207mm	2248 x 2205mm	2276 x 2205mm
7364	2222 x 1930mm	2368 x 2003mm	2336 x 2001mm	2364 x 2001mm
7566	2261 x 1981mm	2407 x 2054mm	2375 x 2052mm	2403 x 2052mm
7570	2261 x 2134mm	2407 x 2207mm	2375 x 2205mm	2403 x 2205mm
7666	2286 x 1981mm	2432 x 2054mm	2400 x 2052mm	2428 x 2052mm
7670	2286 x 2134mm	2432 x 2207mm	2400 x 2205mm	2428 x 2205mm
8066	2438 x 1981mm	2584 x 2054mm	2552 x 2052mm	2580 x 2052mm
8070	2438 x 2134mm	2584 x 2207mm	2552 x 2205mm	2580 x 2205mm

Brickwork aperture sizes for frames fitted BEHIND the opening

Size code	Door size	Timber frame (70 x 70mm)	54mm Quick-fit steel frame	68mm Quick-fit steel frame
		Brickwork aperture	Brickwork aperture	Brickwork aperture
6666	1981 x 1981mm	2007 x 1981mm	2007 x 1981mm	2007 x 1981mm
6670	1981 x 2134mm	2007 x 2134mm	2007 x 2134mm	2007 x 2134mm
7066	2134 x 1981mm	2160 x 1981mm	2160 x 1981mm	2160 x 1981mm
7070	2134 x 2134mm	2160 x 2134mm	2160 x 2134mm	2160 x 2134mm
7364	2222 x 1930mm	2248 x 1930mm	2248 x 1930mm	2248 x 1930mm
7566	2261 x 1981mm	2287 x 1981mm	2287 x 1981mm	2287 x 1981mm
7570	2261 x 2134mm	2287 x 2134mm	2287 x 2134mm	2287 x 2134mm
7666	2286 x 1981mm	2312 x 1981mm	2312 x 1981mm	2312 x 1981mm
7670	2286 x 2134mm	2312 x 2134mm	2312 x 2134mm	2312 x 2134mm
8066	2438 x 1981mm	2464 x 1981mm	2464 x 1981mm	2464 x 1981mm
8070	2438 x 2134mm	2464 x 2134mm	2464 x 2134mm	2464 x 2134mm

Maximizer® Retractable Gear



Standard door and brickwork aperture sizes

- Cardale Slideaway Retractable door gear should be fitted to a weatherbeaded 70mm x 70mm standard timber 'goalpost' frame (not supplied). Alternatively Slideaway single and double doors up to 4876mm may be fitted to a Cardale Quick-fit steel Slideaway frame (single door dimensions = 68mm wide by 60mm deep all round, double door dimensions = 68mm wide x 75mm deep all round).
- The minimum headroom required above the lower face of the top timber or lintel is 43mm for double doors, 38.5mm for single doors.
- Optional Maximiser retractable lifting gear is available for single sized Cardale doors up to 2438mm (8'0") wide by 2286mm (7'6") high only.

Notes

- Door sizes given are for opening sizes within the frame. Door leaves are approximately 19mm narrower and 25mm shorter than the dimensions given to allow for clearances and tolerances.
- In use, single and double slideaway lifting gear reduces drive through width by 114mm (4 1/2") and height by 127mm (5"). With optional Maximizer gear there is no reduction in drive through width up to 1050mm from the ground on 1981mm high doors (1200mm on 2134mm high doors), and only an 80mm reduction in height.
- 'Within the brickwork' aperture dimensions include a 3mm gap between the frame and brickwork on all three sides to allow for coursing and tolerances.
- 'Behind the brickwork' aperture dimensions allow the frame to overlap into the aperture by 13mm on both sides to allow for coursing and tolerances.
- Slideaway frames for single and double doors are also available 7'6" high for single doors and 8'0" high for double doors.
- Special size frames are available in any size from 6'6" x 6'1" to 16'0" x 8'0"

Brickwork aperture sizes for frames fitted WITHIN the opening

Size code	Door size	Timber frame (70x70mm)	Quick-fit steel frame
		Brickwork aperture	Brickwork aperture
6666	1981 x 1981mm	2127 x 2054mm	2123 x 2052mm
6670	1981 x 2134mm	2127 x 2207mm	2123 x 2205mm
7066	2134 x 1981mm	2280 x 2054mm	2276 x 2052mm
7070	2134 x 2134mm	2280 x 2207mm	2276 x 2205mm
7364	2222 x 1930mm	2368 x 2003mm	2364 x 2001mm
7566	2261 x 1981mm	2407 x 2054mm	2403 x 2052mm
7570	2261 x 2134mm	2407 x 2207mm	2403 x 2205mm
7666	2286 x 1981mm	2432 x 2054mm	2428 x 2052mm
7670	2286 x 2134mm	2432 x 2207mm	2428 x 2205mm
8066	2438 x 1981mm	2584 x 2054mm	2580 x 2052mm
8070	2438 x 2134mm	2584 x 2207mm	2580 x 2205mm
1466	4267 x 1981mm	4413 x 2054mm	4413 x 2052mm
1470	4267 x 2134mm	4413 x 2207mm	4413 x 2205mm

Brickwork aperture sizes for frames fitted BEHIND the opening

Size code	Door size	Timber frame (70x70mm)	Quick-fit steel frame
		Brickwork aperture	Brickwork aperture
6666	1981 x 1981mm	2007 x 1981mm	2007 x 1981mm
6670	1981 x 2134mm	2007 x 2134mm	2007 x 2134mm
7066	2134 x 1981mm	2160 x 1981mm	2160 x 1981mm
7070	2134 x 2134mm	2160 x 2134mm	2160 x 2134mm
7364	2222 x 1930mm	2248 x 1930mm	2248 x 1930mm
7566	2261 x 1981mm	2287 x 1981mm	2287 x 1981mm
7570	2261 x 2134mm	2287 x 2134mm	2287 x 2134mm
7666	2286 x 1981mm	2312 x 1981mm	2312 x 1981mm
7670	2286 x 2134mm	2312 x 2134mm	2312 x 2134mm
8066	2438 x 1981mm	2464 x 1981mm	2464 x 1981mm
8070	2438 x 2134mm	2464 x 2134mm	2464 x 2134mm
1466	4267 x 1981mm	4293 x 1981mm	4293 x 1981mm
1470	4267 x 2134mm	4293 x 2134mm	4293 x 2134mm